

# **WESTCHESTER MODULAR HOMES, INC.**

AN EMPLOYEE OWNED COMPANY

## Table of Contents

Page:

|     |   |
|-----|---|
| 2   | Shaw Carpet   |
| 10  | Flooring  |
| 23  | Fireplaces  |
| 27  | 400 Series Windows                                      |
| 34  | 200 Series Windows                                      |
| 37  | Smooth Star Ext Doors                                   |
| 42  | Fiber Classic Oak Ext Doors                             |
| 44  | Fiber Classic Mahogany Ext Doors                        |
| 46  | Classic Craft Fir Ext Doors                             |
| 47  | Exterior Door Hardware                                  |
| 52  | Exterior Patio Doors                                    |
| 57  | Sky lights  |
| 58  | Light Fixture Packages                                  |
| 63  | Recessed Lights   |
| 64  | Central Vac System                                      |
| 66  | Interior Doors  |
| 73  | Interior Door Hardware                                  |
| 74  | Interior Trim Options                                   |
| 76  | Merillat Cabinets                                       |
| 97  | Merillat Kitchen Upgrade Options                        |
| 100 | Kitchen & Bath Countertop Options                       |
| 109 | Delta Kitchen Faucet Options                            |
| 111 | Range Hoods   |
| 112 | Whirlpool Appliances                                    |
| 114 | Cultured Marble, Granite & Quartz Vanity Options        |
| 121 | Medicine Cabinets                                       |
| 122 | Vanity Lights   |
| 124 | Bath Vanity Layouts                                     |
| 126 | Bath Fans   |
| 129 | Delta Bath Faucet Options                               |
| 131 | Bath Accessories  |
| 134 | Bath Fixture Options                                    |
| 136 | Tub & Shower Options                                    |
| 139 | Delta Tub/Shower Faucets                                |
| 142 | Whirlpool Tubs  |
| 142 | Delta Roman Tub Faucet Options/ Additional Bath Options |
| 144 | Mustee Laundry Tubs & Sinks                             |
| 145 | Exterior Siding Selections                              |
| 152 | Exterior Corner Posts                                   |
| 154 | Shutters  |
| 155 | TruDefinition Duration Shingles                         |





CARPET

**SHAKE IT UP (A)**  
Broadloom

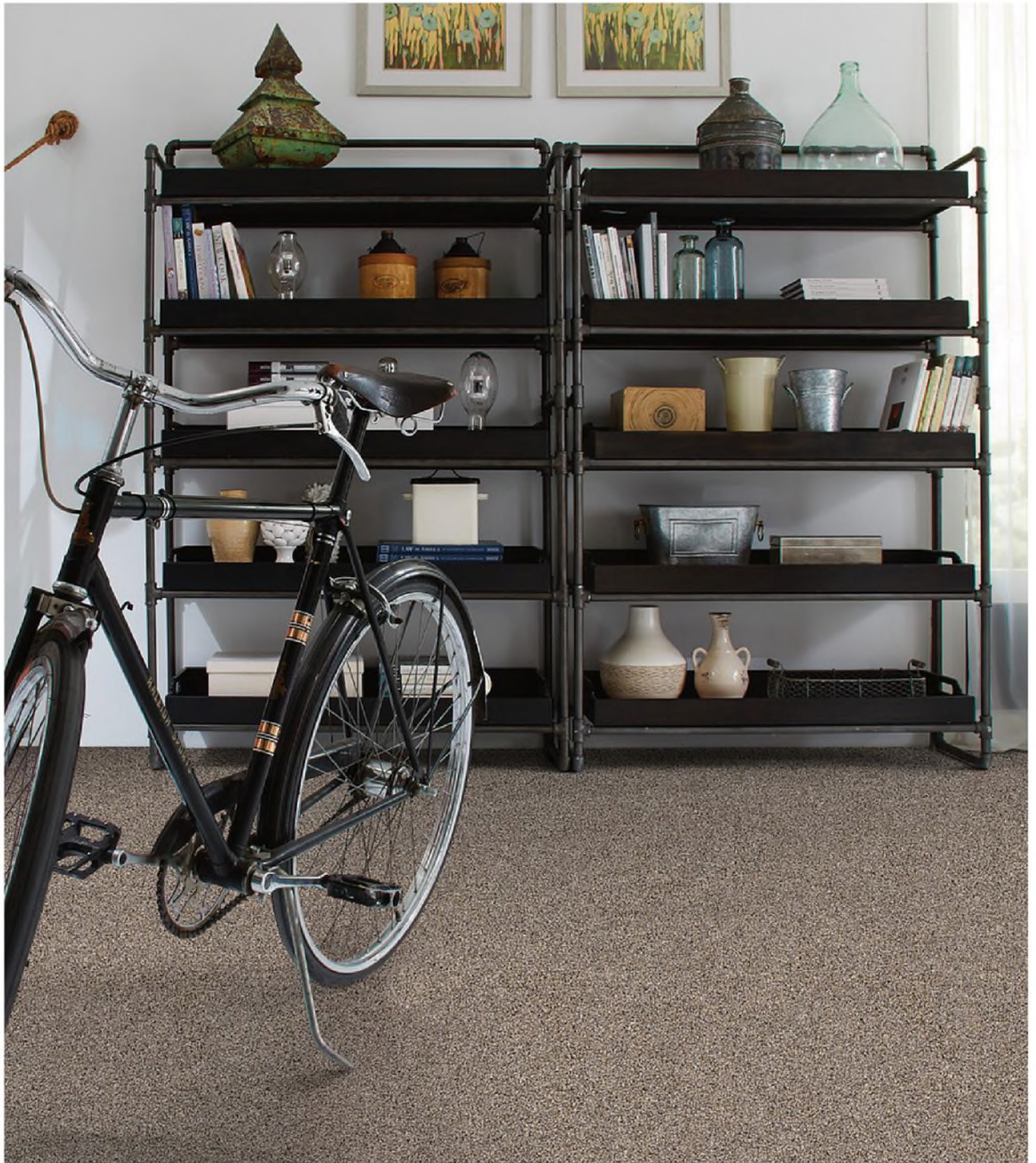

500 Burnt Ash



**Colors**



Tree Bard 706



Burnt Ash 500



English Oak 700



Oxford 512



Bits of Brown 200



Fox Fur 102



Daytona Sand 105



Creamy Silk 100



CARPET

**SHAKE IT UP (S)**  
Broadloom



510 Cement

shawfloors.com

**Shaw**  
FLOORS

For reference purposes only if printed or downloaded.



# SHAKE IT UP (S)

STANDARD 25 oz

# CARPET



Morning Latte 732



Forever Pewter 710

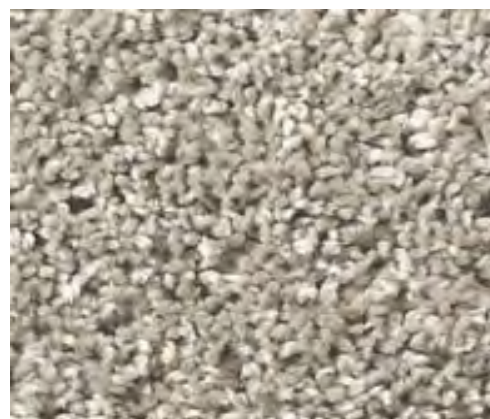

Cement 510



Breeze 111



Beach 112



# CARPET

# SHAKE IT UP (T)

Broadloom



Hammerhead 521



**Colors**



Rodeo 710



Hammerhead 521



Silversmith 501



Dolphin 520



Owl 121



Barely There 720



Ornamental Gate 122

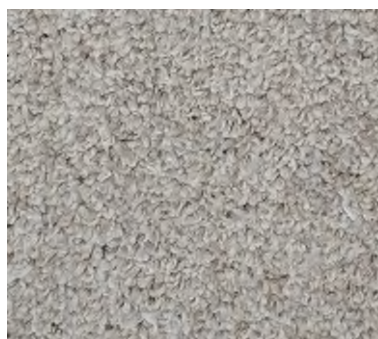

Balboa Mist 128



Magnolia Bloom 120



Stucco 112



# CARPET

# TRUE SPIRIT



City Scape 511





Colors



Lady Liberty 502



Concrete 507



City Scape 511



Cottage 705



Truffle 701





**WESTCHESTER MODULAR HOMES, INC.**

AN EMPLOYEE OWNED COMPANY

BUILDER STUDIO 2022





# WHY TILE

## SETS THE STANDARD

### BEAUTIFUL. STRONG. PURE. UNEQUALED.

**50%<sup>MORE</sup>**  
SLIP RESISTANT  
THAN ORDINARY TILE\*

#### STEPWISE

Technology to confidently step anywhere with increased slip-resistance over standard tile.



#### SCRATCH-RESISTANT

Naturally scratch-resistant, tile continues to look good even after years of heavy traffic.



#### SLIP-RESISTANT

Tile rated at a 0.42 DCOF or greater when wet will help keep your feet firmly planted on the ground.



#### FIRE-RESISTANT

Noncombustible, tile will not burn, melt or give off toxic fumes when it is exposed to fire.



#### WATERPROOF

Spills and puddles are no match for porcelain tile; even if they sit for awhile your floors are impervious to liquid.<sup>1</sup>



#### INDOOR/OUTDOOR

Take your inside out with tile designed for seamless transitions from interior floors and walls directly to your outdoor space with ultimate performance and durability.<sup>4</sup>



#### STAINPROOF

Because of its low porosity, porcelain does not stain. Even coffee, wine and the muddiest messes cannot touch it.<sup>2</sup>



#### CLIMATEPRO™

Tile that won't freeze, fade or crack due to cold weather. Perfect for indoor or vertical applications for outdoor spaces.



#### DENTPROOF

With innate durability and exceptional strength, dents and dings are no longer a worry.<sup>3</sup>



#### SIMPLICLEAN™

All tile is easy to clean with a broom, vacuum or wet mop.<sup>5</sup>

BY CHOOSING TILE, YOU ARE CHOOSING  
THE CLEAN SOLUTION WITH  
**NO VOCs, PVCs, FORMALDEHYDE OR ALLERGENS.**

VISIT [DAL TILE.COM/WHY-DAL TILE/WHY-TILE](http://DAL TILE.COM/WHY-DAL TILE/WHY-TILE) TO LEARN MORE ABOUT THE BENEFITS OF TILE.

\* When compared to tile meeting ANSI standards.

1. The term "waterproof" applies to the tile product itself and does not extend to the subfloor or adhesives; it does not apply to moisture or water coming from below/underneath the product and it does not apply to flooding or intentional damage or misuse. 2. With use of normal household products & chemicals. 3. Does not apply to chipping. 4. Applies to approved applications in freezing and/or non-freezing climates. 5. Does not require specialized cleaners.



# CORE FUNDAMENTALS™ -CHOICE

FINISHES: MATTE

## GLAZED CERAMIC FLOOR TILE

### FLOOR TILE



IVORY AR04



CASPER AR05



FAWN AR02

#### AVAILABLE TILE SIZES



12 x 24  
Floor Tile



12 x 12  
Floor Tile



FAIR CS22



BUFF CS20



IRON CS23

#### AVAILABLE TILE SIZES



12 x 24  
Floor Tile



12 x 12  
Floor Tile

COORDINATING TRIM FINISHES ALSO AVAILABLE.

FOR COMPLETE PRODUCT INFORMATION, PLEASE VISIT [WWW.DAL TILE/CORE-FUNDAMENTALS](http://WWW.DAL TILE/CORE-FUNDAMENTALS)



# CORE FUNDAMENTALS™ – ADVANTAGE

FINISHES: MATTE

## GLAZED CERAMIC FLOOR TILE

### FLOOR TILE



OFF WHITE AR30

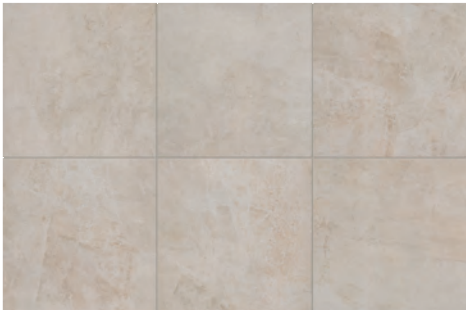

LIGHT BEIGE AR31

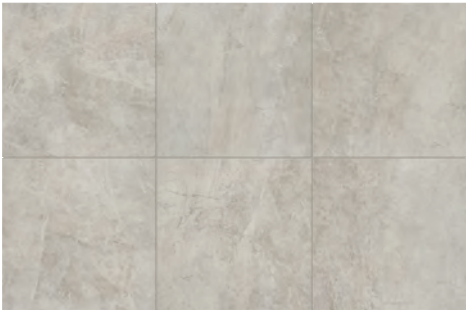

LIGHT GRAY AR32

### AVAILABLE TILE SIZES

---



12 x 24  
Floor Tile



12 x 12  
Floor Tile

---



# CORE FUNDAMENTALS™ –PRIME

## GLAZED CERAMIC FLOOR TILE

FINISHES: MATTE

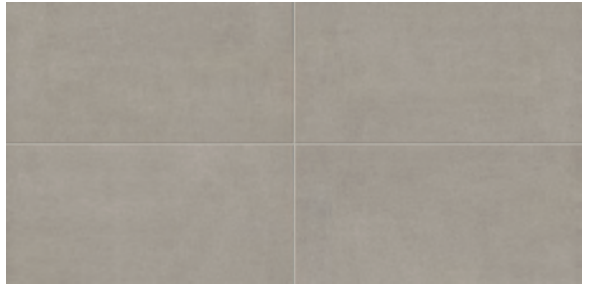

Photo features Grey KC04 12 x 24 floor

### FLOOR TILE



WHITE KC01



GREY KC04

### AVAILABLE TILE SIZES



12 x 24  
Floor Tile



12 x 12  
Floor Tile

FOR COMPLETE PRODUCT INFORMATION,  
PLEASE VISIT [WWW.DAL TILE/CORE-FUNDAMENTALS](http://WWW.DAL TILE/CORE-FUNDAMENTALS)



# CORE FUNDAMENTALS™ –PRIME

GLAZE CERAMIC FLOOR TILE

FINISHES: MATTE

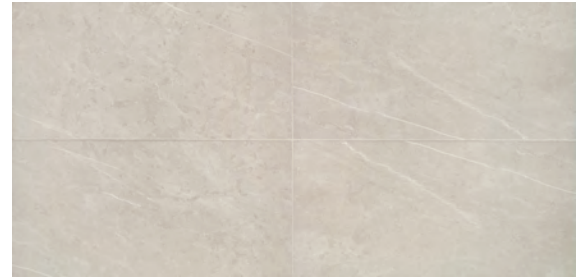

Photo features Vitality White RL20 12 x 24 on the floor.

## FLOOR TILE



VITALITY WHITE RL20



DYNAMIC BEIGE RL21



STAMINA GREY RL23

## AVAILABLE TILE SIZES



12 x 24  
Floor Tile



12 x 12  
Floor Tile

FOR COMPLETE PRODUCT INFORMATION,  
PLEASE VISIT [WWW.DAL TILE/CORE-FUNDAMENTALS](http://WWW.DAL TILE/CORE-FUNDAMENTALS)

# ADA COMPLIANT STEPWISE\* TECHNOLOGY

ALL STYLE. NO SLIPS.

Don't tip-toe through life. Step stylishly on non-slip tile that's 50% more slip resistant than ordinary tile. And because it's Daltile, you'll find beautiful natural looks that are waterproof, scratchproof, stainproof and dentproof

## VOLUME 1.0™

GLAZED PORCELAIN FLOOR with STEPWISE™ TECHNOLOGY



SONIC WHITE VL75



DEGREES SILVER VL71▲



STEREO GREY VL73▲



ELECTRIC MOSS VL79▲



INTENSITY PEBBLE VL72



REVERB ASH VL74



ACCENT BROWN VL78



AMPLIFY BLACK VL70

### AVAILABLE TILE SIZES



12 x 24  
Floor Tile



12 x 12  
Floor Tile

▲ Also available with Microban in 12 x 24.

Products are grouped by pricing tiers, Tier 1 being the least expensive. Some tiles may fit into higher tiers due to size, accent or possible added labor.



# 50% MORE SLIP RESISTANT THAN ORDINARY TILE\*

\*When compared to tile meeting ANSI standard

FEATURING



## StepWise™ Technology

# ALL STYLE. NO SLIPS.

## STYLISH ON-TREND DESIGNS

Create an impressive space in any room.

## NEVER WEARS OFF

Durability you can count on.

## EASY TO CLEAN

Go ahead, let life get messy.

## NATURALLY SAFE

Free of toxic chemicals making it safe for you and your loved ones.

## MADE IN THE U.S.A.

Locally produced in your own backyard.



SLIP RESISTANT



WATERPROOF



SCRATCHPROOF



STAINPROOF



DENTPROOF



INDOOR/  
OUTDOOR



SIMPLICLEAN™

# FLORENTINE™

## GLAZE PORCELAINE FLOOR TILE



Photo features Florentine™ Nociolla 12 x 24 floor tile in staggered brick-joint pattern on the floor and Nociolla 12 x 24 wall tile in grid pattern on the wall.

### FLOOR TILE



CARRARA FL06



MARFIL FL07



ARGENTO FL08

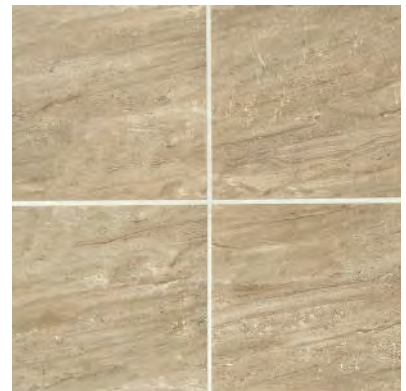

NOCIOLLA FL09

### AVAILABLE TILE SIZES



12 x 24  
Floor Tile



12 x 12  
Floor Tile

Products are grouped by pricing tiers, Tier 1 being the least expensive. Some tiles may fit into higher tiers due to size, accent or possible added labor.





# Made in the U.S.A



## STATE OF THE ART MANUFACTURING

9 MANUFACTURING PLANTS RIGHT HERE IN THE USA

- Positioned with the Fastest Speed to Market



## UNPARALLELED SERVICE

LARGEST FOOTPRINT OF DISTRIBUTION & SERVICE LOCATIONS NATIONWIDE

- Over 70 Years Proven Support of Remarkable Products & Service



## INNOVATIVE STYLE

INDUSTRY LEADING TECHNOLOGY FROM DESIGN TO MANUFACTURING

- Product Features Designed to Set the Standard



## ULTIMATE SOLUTION

TILE DESIGNED TO WITHSTAND EVERYDAY LIFE

- Unparalleled Design Flexibility & Style
- Outstanding Durability & Performance
- Easy to Clean & Maintain
- No VOCs, No PVCs, No Allergens, No Worries

# Grouts for every purpose



## SERENE

|                     |          |                 |                                     |
|---------------------|----------|-----------------|-------------------------------------|
| 38 Avalanche        | 77 Frost | 93 Warm Gray    | 01 Alabaster<br><b>Discontinued</b> |
| <b>Discontinued</b> | 101 Rain | 103 Cobblestone | 104 Timberwolf                      |
| 102 Mint            |          |                 |                                     |

## TRADITIONAL

|               |            |                     |                     |
|---------------|------------|---------------------|---------------------|
| 5220 Eggshell | 14 Biscuit | <b>Discontinued</b> | <b>Discontinued</b> |
| 02 Pewter     | 27 Silver  | 94 Straw            | 39 Ivory            |
|               |            | 107 Iron            | 19 Pearl Gray       |

## NATURAL

|                     |               |                     |                     |
|---------------------|---------------|---------------------|---------------------|
| 06 Harvest          | 44 Pale Umber | <b>Discontinued</b> | <b>Discontinued</b> |
| <b>Discontinued</b> | 105 Driftwood | <b>Discontinued</b> | <b>Discontinued</b> |
| 106 Walnut          |               | 35 Navajo Brown     | 108 Bamboo          |
|                     |               | 111 Hickory         | 42 Mocha            |

## ROMANCE

|                     |                     |                     |                     |
|---------------------|---------------------|---------------------|---------------------|
| <b>Discontinued</b> | 15 Bone             | 05 Chamois          | <b>Discontinued</b> |
| 49 Light Almond     | <b>Discontinued</b> | <b>Discontinued</b> | 109 Acorn           |
| <b>Discontinued</b> | 112 Pecan           | 113 Brick Red       | <b>Discontinued</b> |
| 110 Caramel         |                     |                     | 114 Mahogany        |

## GLAMOUR

|                     |                     |                     |             |
|---------------------|---------------------|---------------------|-------------|
| <b>Discontinued</b> | <b>Discontinued</b> |                     |             |
| 11 Sahara Beige     | 04 Bahama Beige     | 09 Gray             | 47 Charcoal |
|                     |                     | <b>Discontinued</b> |             |
| 79 Cocoa            | 07 Chocolate        | 115 Truffle         | 10 Black    |





Reclaimed Pine 166

# Intrepid HD Plus

## COLORS



Distressed Pine 164



Reclaimed Pine 166



Salvaged Pine 554



Antique Pine 5006



Shawshank Oak 168



Chestnut Oak 5010



Ravine Oak 798



Misty Oak 5008



Charred Oak 5009

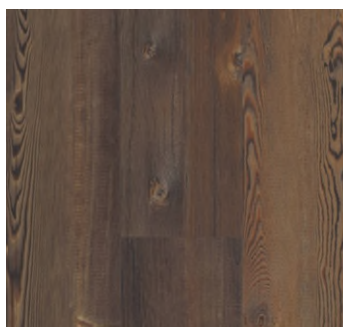

Forest Pine 812



Silver Oak 5003



Wye Oak 5004







**WESTCHESTER MODULAR HOMES, INC.**  
AN EMPLOYEE OWNED COMPANY

# Fireplace, Mantle, & Surround Selections

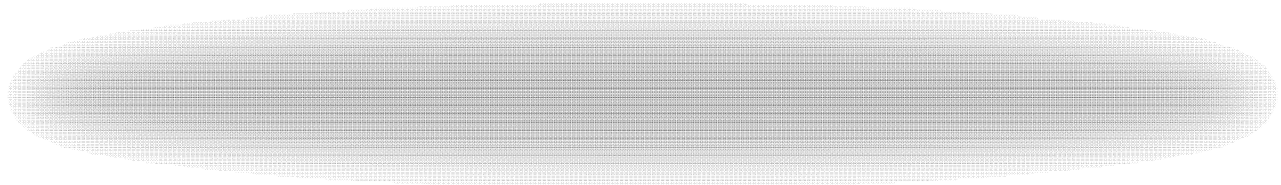

Westchester Modular Homes, Inc.  
30 Reagans Mill Road  
Wingdale, NY 12594  
800-832-3888 + [WestchesterModular.com](http://WestchesterModular.com)

**heatilator**  
*The first name in fireplaces*

Rev. 12/20

# MANTLE OPTIONS



Kenwood

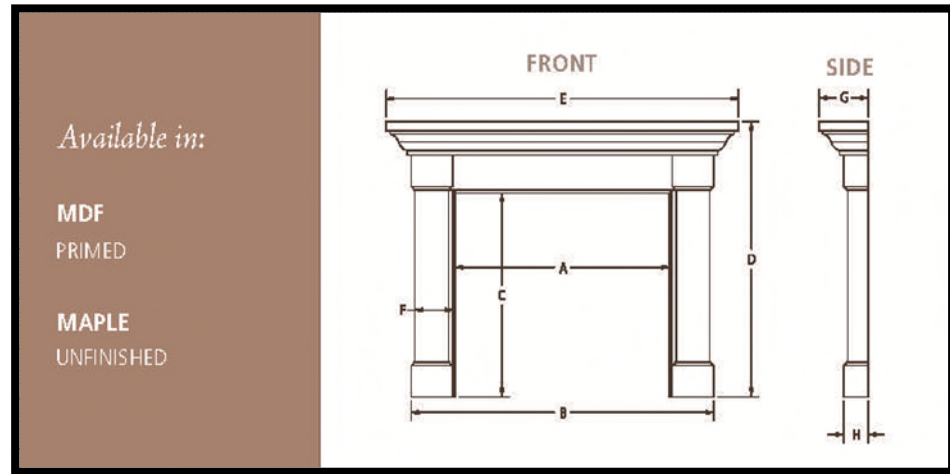

| Kenwood<br>(Without Base) | A<br>OPENING<br>WIDTH | B<br>OUTSIDE<br>WIDTH | C<br>OPENING<br>HEIGHT | D<br>OUTSIDE<br>HEIGHT | E<br>TOP<br>WIDTH | F<br>LEG<br>WIDTH | G<br>SHELF<br>DEPTH | H<br>LEG<br>DEPTH | I<br>RECOMMENDED<br>SET SIZE |
|---------------------------|-----------------------|-----------------------|------------------------|------------------------|-------------------|-------------------|---------------------|-------------------|------------------------------|
| A SIZE                    | 44"                   | 60"                   | 36-1/2"                | 48-3/4"                | 69-1/2"           | 8"                | 9-3/4"              | 5"                | 6                            |
| B SIZE                    | 48"                   | 65"                   | 39-1/2"                | 51-3/4"                | 74-1/2"           | 8"                | 9-3/4"              | 5"                | 1                            |
| C SIZE                    | 53"                   | 70"                   | 42"                    | 54-1/4"                | 79-1/2"           | 8"                | 9-3/4"              | 5"                | 1                            |



Battlefield

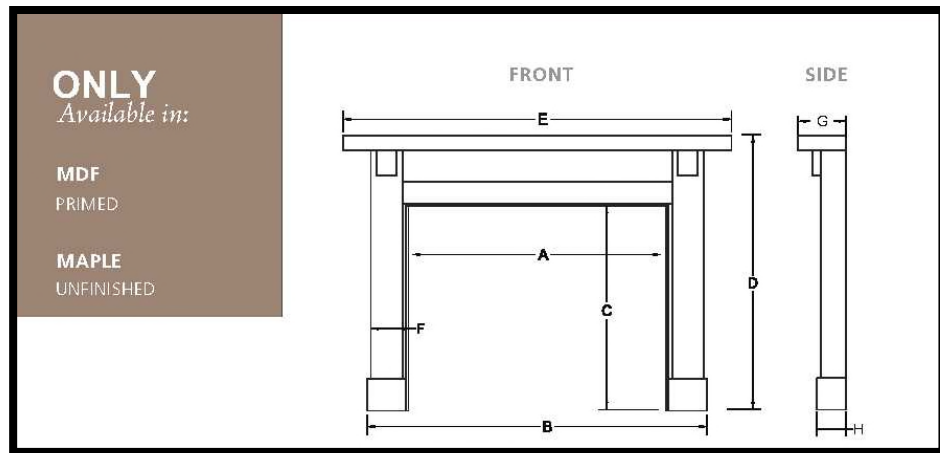

| Battlefield | A<br>OPENING<br>WIDTH | B<br>OUTSIDE<br>WIDTH | C<br>OPENING<br>HEIGHT | D<br>OUTSIDE<br>HEIGHT | E<br>TOP<br>WIDTH | F<br>LEG<br>WIDTH | G<br>SHELF<br>DEPTH | H<br>LEG<br>DEPTH | I<br>RECOMMENDED<br>SET SIZE |
|-------------|-----------------------|-----------------------|------------------------|------------------------|-------------------|-------------------|---------------------|-------------------|------------------------------|
| B SIZE      | 48"                   | 65"                   | 39-1/2"                | 54"                    | 75"               | 6-1/2"            | 9"                  | 5-1/4"            | 1                            |
| C SIZE      | 53"                   | 70"                   | 42"                    | 56-1/2"                | 80"               | 6-1/2"            | 9"                  | 5-1/4"            | 1                            |



# MANTLE OPTIONS



Acadia

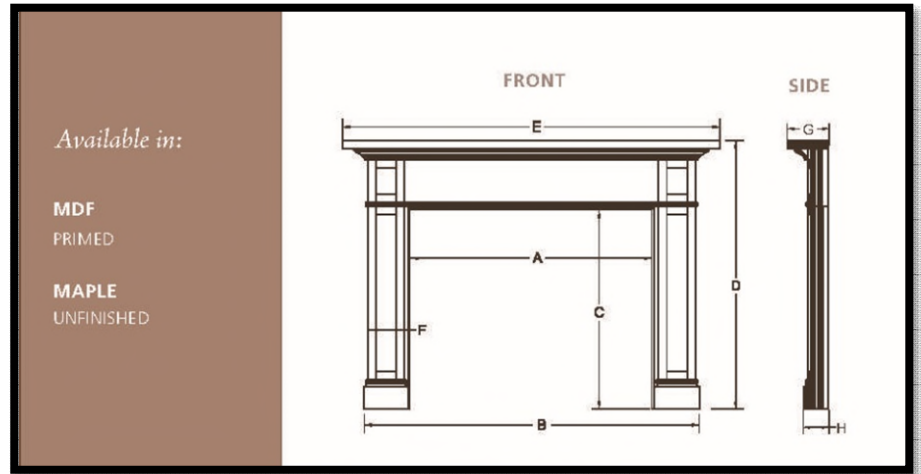

| Acadia | A<br>OPENING<br>WIDTH | B<br>OUTSIDE<br>WIDTH | C<br>OPENING<br>HEIGHT | D<br>OUTSIDE<br>HEIGHT | E<br>TOP<br>WIDTH | F<br>LEG<br>WIDTH | G<br>SHELF<br>DEPTH | H<br>LEG<br>DEPTH | I<br>RECOMMENDED<br>SET SIZE |
|--------|-----------------------|-----------------------|------------------------|------------------------|-------------------|-------------------|---------------------|-------------------|------------------------------|
| A SIZE | 44"                   | 61-1/2"               | 36-1/2"                | 49"                    | 69"               | 6-3/4"            | 7-1/2"              | 3-3/4"            | 1                            |
| B SIZE | 48"                   | 65-1/2"               | 39-1/2"                | 52"                    | 73"               | 6-3/4"            | 7-1/2"              | 3-3/4"            | 1                            |
| C SIZE | 53"                   | 70"                   | 42"                    | 54-1/2"                | 78"               | 6-3/4"            | 7-1/2"              | 3-3/4"            | 12                           |

## Wood Species



MDF  
Primed

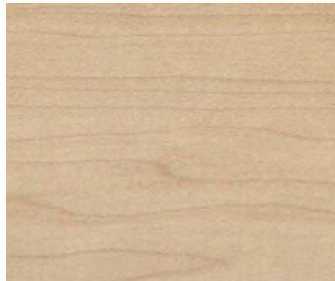

Maple  
Unfinished

## Stone Surround Options

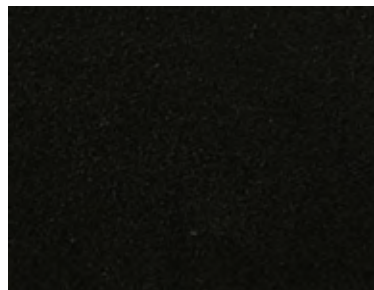

Absolute Black



New Venetian Gold

# Fireplace Rough Openings

## Accelerator

36" Wood Fireplace

| MODEL     | FRONT WIDTH |         | BACK WIDTH |         | HEIGHT |         | DEPTH  |         | FIREPLACE OPENING |
|-----------|-------------|---------|------------|---------|--------|---------|--------|---------|-------------------|
|           | Actual      | Framing | Actual     | Framing | Actual | Framing | Actual | Framing |                   |
| A36C/A36R | 42          | 43      | 28-1/4     | 43      | 41-1/4 | 41-1/2  | 22-3/4 | 23      | 36 x 23-3/8       |

## Accelerator

42" Wood Fireplace

| MODEL     | FRONT WIDTH |         | BACK WIDTH |         | HEIGHT |         | DEPTH  |         | FIREPLACE OPENING |
|-----------|-------------|---------|------------|---------|--------|---------|--------|---------|-------------------|
|           | Actual      | Framing | Actual     | Framing | Actual | Framing | Actual | Framing |                   |
| A42C/A42R | 48          | 49      | 30-7/8     | 49      | 41-1/4 | 41-1/2  | 22-3/4 | 23      | 42 x 23-3/8       |

## Novus

36" Direct Vent Gas Fireplace

| MODEL     | FRONT WIDTH |         | BACK WIDTH |         | HEIGHT |         | DEPTH  |         | VIEWING AREA |
|-----------|-------------|---------|------------|---------|--------|---------|--------|---------|--------------|
|           | Actual      | Framing | Actual     | Framing | Actual | Framing | Actual | Framing |              |
| NDV30-IFT | 35          | 36      | 8-5/8      | 36      | 35-1/4 | 34-7/8  | 19-1/8 | 19-5/8  | 30 x 22-5/8  |

## Novus

42" Direct Vent Gas Fireplace

| MODEL     | FRONT WIDTH |         | BACK WIDTH |         | HEIGHT |         | DEPTH  |         | VIEWING AREA |
|-----------|-------------|---------|------------|---------|--------|---------|--------|---------|--------------|
|           | Actual      | Framing | Actual     | Framing | Actual | Framing | Actual | Framing |              |
| NDV36-IFT | 41          | 42      | 14-5/8     | 42      | 35-1/4 | 34-7/8  | 19-1/8 | 19-5/8  | 36 x 22-5/8  |



**Modular Homes**

AN EMPLOYEE OWNED COMPANY

[westchesterm modular.com](http://westchesterm modular.com)

800-832-3888



# Andersen® 400 Series Windows (Standard)

- **White or Optional clear Pine interior**
- **Screens & “Snap-In” Grills are standard**
- **Six exterior optional colors**
- **Energy efficient**
- **Dual-layer, compressible bulb weather-stripping seals out dust, wind and water**



## Tilt-Wash Double Hung

Double-hung windows have two sash in a single frame which slide up or down to provide ventilation. Because their sash remain flush with the wall while the window is open, they are a good choice for placement adjacent to patios, decks and walkways. Our best-selling double-hung window, the Andersen® 400 Series tilt-wash double-hung window is extremely energy efficient and gives you a wide array of decorative and performance options, including Stormwatch® protection.



### Bow Window

Bow windows are window combinations that curve gradually and gracefully outside a home. These dramatic combinations can add space, volume and light to a room and add more personality to any home—inside and out. Andersen® 400 Series bow window units utilize all of the individual qualities of our casement windows.



### Angle Bay

Bay windows are window combinations that project outward from a home. These dramatic combinations can add space, volume and light to a room and add more personality to any home—inside and out. Andersen® 400 Series tilt-wash double-hung bay windows are extremely energy efficient and give you a wide array of decorative and performance options.





## Casement Windows

Casement windows are hinged on the side and open outward to the left or right, allowing you to catch breezes and direct the flow of fresh air into your home. Usually taller than they are wide, their entire sash opens to provide top-to-bottom ventilation. This also makes them a frequent choice for use as egress windows—ones that can be used as an emergency exit.

Andersen® 400 Series casement windows start with a design that is extremely energy efficient. Add to that a solid-wood sash covered inside and out by low maintenance Perma-Shield® cladding to protect against water damage. It's easy to see why they have become our best-selling casement window of all time.



## Awning Windows

Awning windows are hinged at the top and open outward. Usually wider than they are tall, their entire sash opens to provide full side-to-side ventilation, allowing them to catch breezes from any direction. They are often used above, below or alongside stationary windows to provide ventilation because, when open, their sash can function like a roof, providing a measure of shelter from light rain.

Andersen® 400 Series awning windows start with a design that is extremely energy efficient. Add to that a solid-wood sash covered inside and out by low maintenance Perma-Shield® cladding to protect against water damage. Then give them rich, natural pine interiors for windows that are as beautiful as they are functional and reliable.



## Picture Windows

Andersen® 400 Series complementary picture windows are rectangular and stationary (non-opening) windows characterized by their dramatic sizes. They can be used to provide singular points of light and architectural accents, or combined to create a signature statement





### Circle Top Windows

Andersen® 400 Series curved specialty windows are stationary (non-opening) windows characterized by their curved shapes. They can be used to provide singular points of light and delicate architectural accents, or combined to create a signature statement.



### Oval Windows

Andersen® 400 Series circle and oval specialty windows are stationary (non-opening) windows characterized by their special shapes. They can be used to provide singular points of light and delicate architectural accents, to create a signature statement.



### **AFFW606 Curved Specialty Window**

Andersen® 400 Series complementary curved specialty windows are stationary (non-opening) windows characterized by their curved shapes. They can be used to provide singular points of light and delicate architectural accents, or combined to create a signature statement.



# Andersen® 400 Series Exterior Window Colors

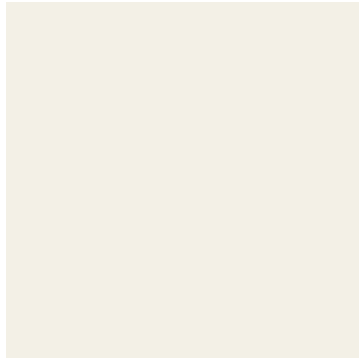

White (Standard)

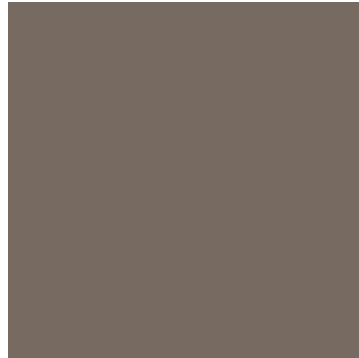

Terratone (Upgrade)



Sandtone (Upgrade)



Forest Green (Upgrade)

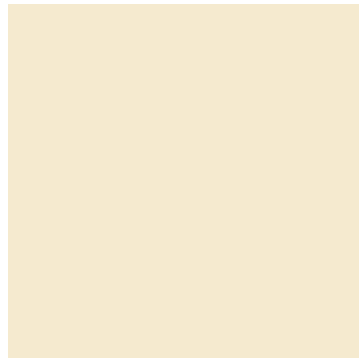

Canvas (Upgrade)



Dark Bronze (Upgrade)



Black (Upgrade)

# Andersen 200® Series Windows (Optional)

- **White or optional pine interior**
- **“Grills between glass” and screens are standard**
- **Available in best-selling sizes with most popular options**
- **Low-maintenance Perma-Shield® exteriors**



**Double Hung Window**

Double-hung windows have two sash in a single frame which slide up or down to provide ventilation. Because their sash remain flush with the wall while the window is open, they are a good choice for walls adjacent to patios, decks and walkways.

The Andersen® 200 Series tilt-wash double-hung windows feature low maintenance Perma-Shield® exteriors along with clear pine interiors to bring the warmth of natural wood into your home. Or, if you prefer, choose a factory-painted white interior with an ultra-smooth low maintenance finish. Either way, they come in our most popular sizes and give you our most requested options, along with our renowned Owner-2-Owner® warranty.

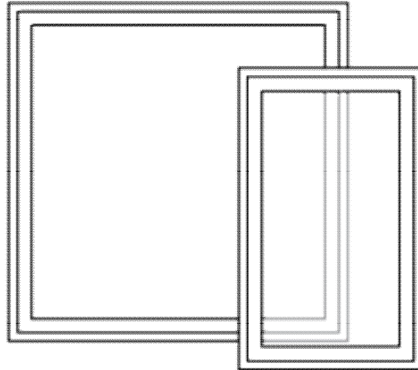

## Picture Windows

Picture windows are stationary, non-opening windows that allow light into the room. Andersen® 200 Series picture windows come with low-maintenance exteriors and real wood or prefinished white interiors along with the security of our renowned Owner-2-Owner® warranty.



## Circle Top Windows

Specialty windows are stationary windows characterized by their curved shapes. Andersen® 200 Series specialty windows are half-circle windows that can be used along with our double-hung windows to make a signature statement in your home and provide a delicate lighting accent.



# Andersen® 200 Series Exterior Window Colors

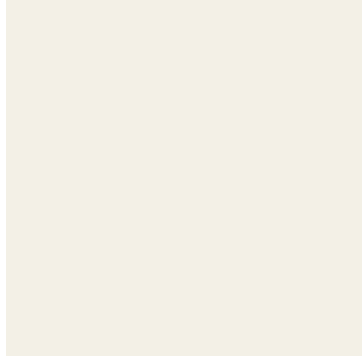

White (Standard)

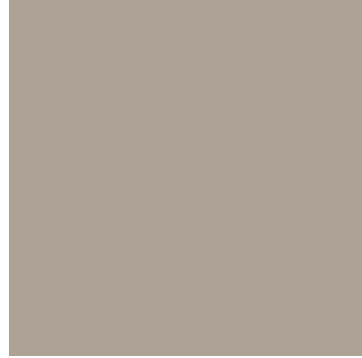

Sandtone (Upgrade)

# Therma Tru® Smooth Star Entry Doors

STANDARD DOOR



S210

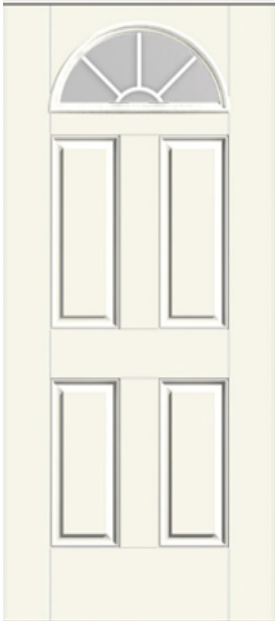

S255



S108



S118



S262



S120



S205



S606



S296



S206



# Smooth Star 14" Sidelights



263SL (Standard)



210SL



308SL



100SL



606SL

# Fire Doors (6'-8" tall)



SE210HD



SE1005HD



SE514



SE978HD

# Transoms (Optional)



19020T



19420T



19220T



19230T



19200T



Therma Tru®

Fiber Classic- Oak Entry Doors (Upgrade)  
(With clear glass)



FC60



FC65

NOTE: Colors shown are just a representation. Doors would need to be stained (by the builder) to achieve those colors.

# 14" Sidelights (Optional)



FC63SL



FC48SL



FC18SL



FC47SL

# Fiber Classic- Mahogany (Upgrade)



FCM60



FCM608



FCM65



FCM606 "Craftsman"

NOTE: Colors shown are just a representation. Doors would need to be stained (by the builder) to achieve those colors.



# 14" Sidelights (Optional)



FCM65SL



FCM62SL



FCM12102SL



FCM12101SL

# Therma Tru® Classic Craft- Fir



CCA230



CCA260

## 14" Classic Craft Fir Sidelights



CCA220SL



CCA210SL



CCA3400SL



CCA3450SL

NOTE: Colors shown are just a representation. Doors would need to be stained (by the builder) to achieve those colors.

# Schlage® Exterior Knobs & Levers



Satin Nickel (Standard)



Aged Bronzed (Upgrade)



Matte Black (Upgrade)



Satin Nickel (Standard)



Aged Bronze (Upgrade)



Matte Black (Upgrade)



# Schlage® Thumb Latch (Upgrade)



Plymouth Oil Rubbed Bronze



Plymouth Satin Nickel



Plymouth Matte Black

# Therma-Tru® Multi-Point Locking Systems (Upgrade)



Heirloom



Venture



Millennium

## Finish Options



Brushed Nickel



Oil-Rubbed Bronze



Black Nickel

## Exterior Patio Doors (Optional)

### Terrace Doors Therma-Tru® Smooth Star



S108



S118

### Sliding Glass Doors Andersen® Perm-Shield





# Andersen® Perma-Shield Colors

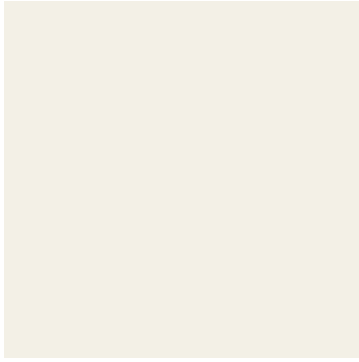

White

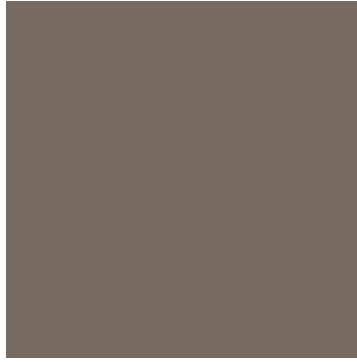

Terratone



Sandtone

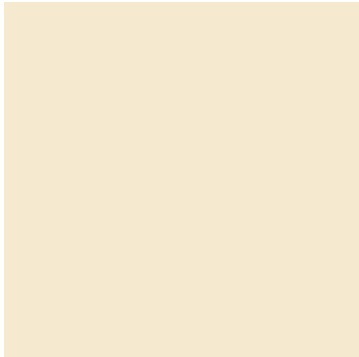

Canvas



Dark Bronze

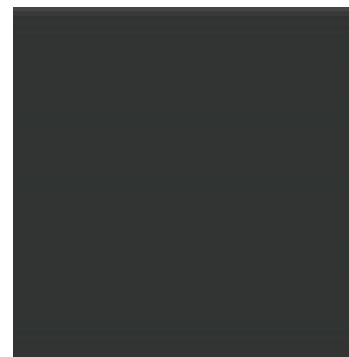

Black

## Andersen® Frenchwood Swing Doors



Grills (Optional)

## Andersen® Frenchwood Gliding Doors



Grills (Optional)

# Andersen® Frenchwood Colors

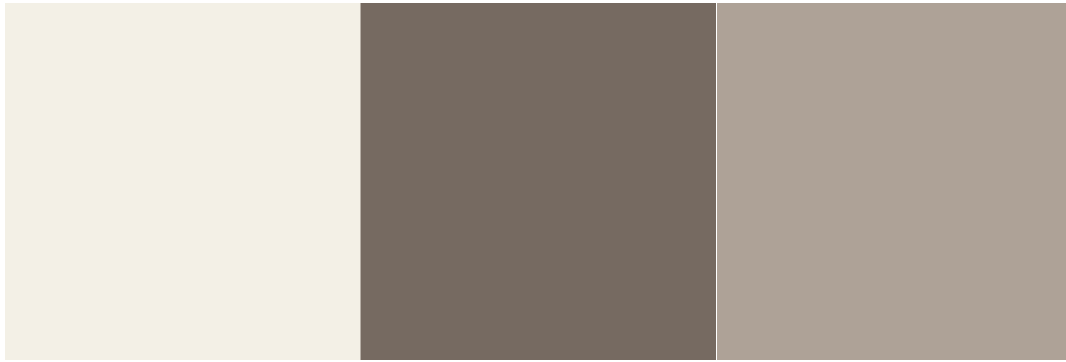

White

Terratone

Sandtone



Forest Green

Black

# Andersen® Frenchwood Hardware



Satin Nickel Finish  
Standard

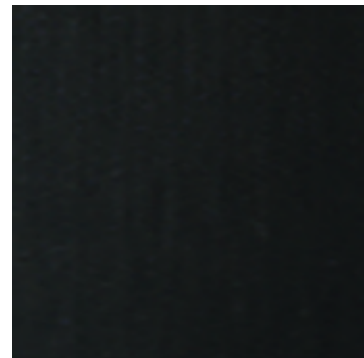

Oil Rubbed Bronze  
Upgrade

# Andersen® Perma-Shield Hardware



White (Only) Standard

## Upgrade Hardware

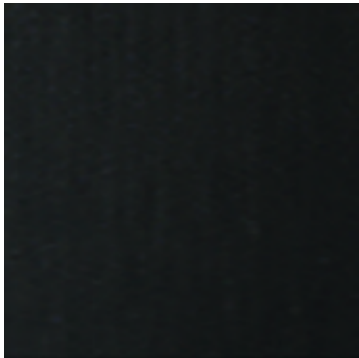

Oil Rubbed Bronze

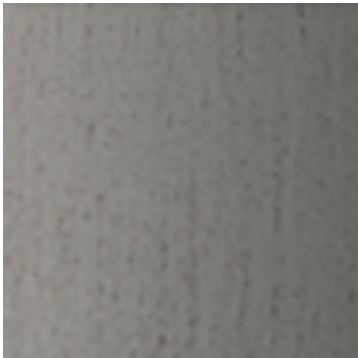

Satin Nickel



Skylights (Optional)  
Vented (VS C04)



Fixed Non-Vented (FS C04)



# Light Fixture Packages

## Holman Interior Collection

### Brushed Nickel



#### Dining Room

**31808-962**

Brushed Nickel Finish

Satin Etched Glass

D: 20" H: 12.5"

(5) Medium Base 60w Max

10' of wire pre-laced through 3' of chain



#### Foyer Two-Story Open

**5233-962**

Brushed Nickel Finish

D: 16.75" H: 29.75"

(6) Candelabra Base 60w Max

Clear Bulb Recommended

12' of wire pre-laced through 88" of chain



#### Breakfast Nook

**65806-962**

Brushed Nickel Finish

Satin Etched Glass

D: 15" H: 12.25"

(1) Medium Base 100w Max

10' of wire pre-laced through 3' of chain



#### Foyer - Hanging

**5231-962**

Brushed Nickel Finish

D: 9.5" H: 16"

(3) Candelabra Base 40w Max

Clear Bulb Recommended

12' of wire pre-laced through 4' of chain

# Holman Interior Collection

## Brushed Nickel



### Foyer - Flush / Optional Bedroom

**77064-962**

Brushed Nickel Finish

Satin Etched Glass

D: 13.25" H: 6.25"

(2) Medium Base 60w Max



### Kitchen

**75943-15**

White Finish

Alabaster Glass

D: 15" H: 7"

(3) Medium Base 60w max.

### Hall Closet

**5328-962**

Brushed Nickel Finish

Smooth White Glass

D: 9.5" H: 5.25" E: 5.25"

(2) Medium Base 60w Max



### Optional Wall Sconce

**41036-999**

Brushed Nickel Finish

Satin Etched Glass

D: 8" H: 8.25" E: 4"

(1) Medium Base 100w max.

Meets ADA Requirements



### Optional Mini-Pendant

**61806-962**

Brushed Nickel Finish

Satin Etched Glass

D: 5.25" H: 6.56"

(1) Medium Base 60w max.

10' of wire, (3) 12" Stems, 12" Chain

# Holman Interior Collection

## Bell Metal Bronze



### Dining Room

**31808-827**

Bell Metal Bronze Finish

Satin Etched Glass

D: 20" H: 12.5"

(5) Medium Base 60w Max

10' of wire pre-laced through 3' of chain



### Foyer Two-Story Open

**5233-782**

Heirloom Bronze Finish

D: 16.75" H: 29.75"

(6) Candelabra Base 60w Max

Clear Bulb Recommended

12' of wire pre-laced through 88" of chain



### Breakfast Nook

**65806-827**

Bell Metal Bronze Finish

Satin Etched Glass

D: 15" H: 12.25"

(1) Medium Base 100w Max

10' of wire pre-laced through 3' of chain



### Foyer - Hanging

**5231-782**

Heirloom Bronze Finish

D: 9.5" H: 16"

(3) Candelabra Base 40w Max

Clear Bulb Recommended

12' of wire pre-laced through 4' of chain



# Holman Interior Collection

## Bell Metal Bronze



**Foyer - Flush / Optional Bedroom**  
**77064-782**

Heirloom Bronze Finish  
Satin Etched Glass  
D: 13.25" H: 6.25"  
(2) Medium Base 60w Max



**Kitchen**  
**75943-15**

White Finish  
Alabaster Glass  
D: 15" H: 7"  
(3) Medium Base 60w max.

**Hall Closet**  
**5328-782**

Heirloom Bronze Finish  
Smooth White Glass  
D: 9.5" H: 5.25" E: 5.25"  
(2) Medium Base 60w Max



**Optional Wall Sconce**  
**41036-999**

Heirloom Bronze Finish  
Satin Etched Glass  
D: 8" H: 8.25" E: 4"  
(1) Medium Base 100w max.  
Meets ADA Requirements



**Optional Mini-Pendant**  
**61806-827**

Bell Metal Bronze Finish  
Satin Etched Glass  
D: 5.25" H: 6.56"  
(1) Medium Base 60w max.  
10' of wire, (3) 12" Stems, 12" Chain

# Jamestowne Exterior Collection

## Antique Bronze



### Exterior - Front

**8457-71**

Antique Bronze Finish

Clear Beveled Glass

W: 5.25" H: 12.5" E: 5.75"

(1) Medium Base 100w Max

Clear Bulb Recommended



### Exterior - Rear

**8592-71**

Antique Bronze Finish

Clear Glass

W: 4.25" H: 8.25" E: 5.5"

(1) Medium Base 100w max.

Clear Bulb Recommended

# Lancaster Exterior Collection

## Antique Bronze

## (Optional Upgrade)



### Upgrade Exterior - Front

**8039-71**

Antique Bronze Finish \*

Clear Beveled Glass

W: 10" H: 20.5" E: 9.5"

(2) Candelabra Base 40w Max

Clear Bulb Recommended



### Upgrade Exterior - Rear

**8037-71**

Antique Bronze Finish \*

Clear Beveled Glass

W: 7" H: 12" E: 7"

(1) Medium Base 100w max.

Clear Bulb Recommended

*\*Also available in  
brushed nickel  
(8039-965 &  
8037-965 respectively)*

# Recessed Lighting



"Generic" Snap-In

Standard

W: 7.625" H: 4.5"

Spring clips for easy installation (snaps to drywall)

IC Airtight Rating

Suitable for wet locations



Nicor DEB56

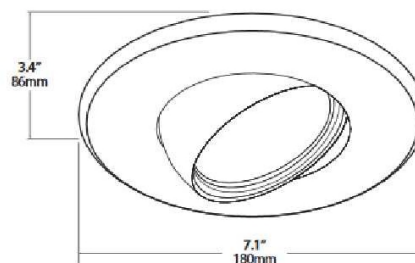

DLR56 and DEB56 fixtures to be installed in a recessed housing

Incandescent IC Airtight Housing

Suitable for shower light

D: 5.625" L: 13.5" W: 8.875" H: 5.5"



# Central Vacuum System's (Optional)



Standard System PP500  
500 Watt Cyclonic Power Unit



Upgrade System PP600  
600 Watt Cyclonic Power Unit



# Central Vacuum Accessories (Included)



Turbine Brush 11" cleaning width



Deluxe Tool Set

# Interior Masonite® Doors

\* Offered in Hollow Core & Solid Core



6 Panel Hollow Core (Standard)



4 Panel (Upgrade)\*



6 Panel Solid Core (Upgrade)

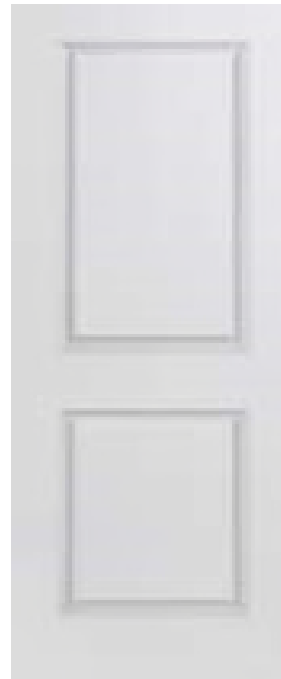

2 Panel Square (Upgrade)\*



Roman Style (Upgrade)\*



Cheyenne (Upgrade)\*



6 Panel Pine (Upgrade)

# Masonite® Heritage Series Solid Core Doors (Upgrade)



Lincoln Park (1 Panel)

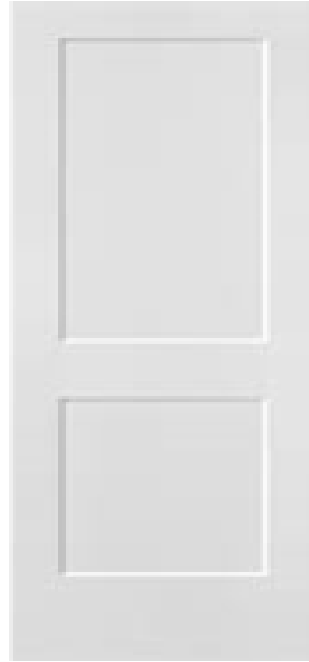

Logan (2 Panel)



Winslow (3 Panel)

# Fire Doors



RF11  
High Definition Panel  
24-Gauge



RF31  
High Definition Panel  
24-Gauge



RF26  
High Definition Panel  
24-Gauge



SE210HD  
High Definition Panel



SE978HD  
High Definition Panel



SE1005HD  
High Definition Panel





SE514  
Standard Definition Panel

# Interior French Doors (Upgrade)

Doors come primed white standard. Available in clear finish



3' 15 Light Door

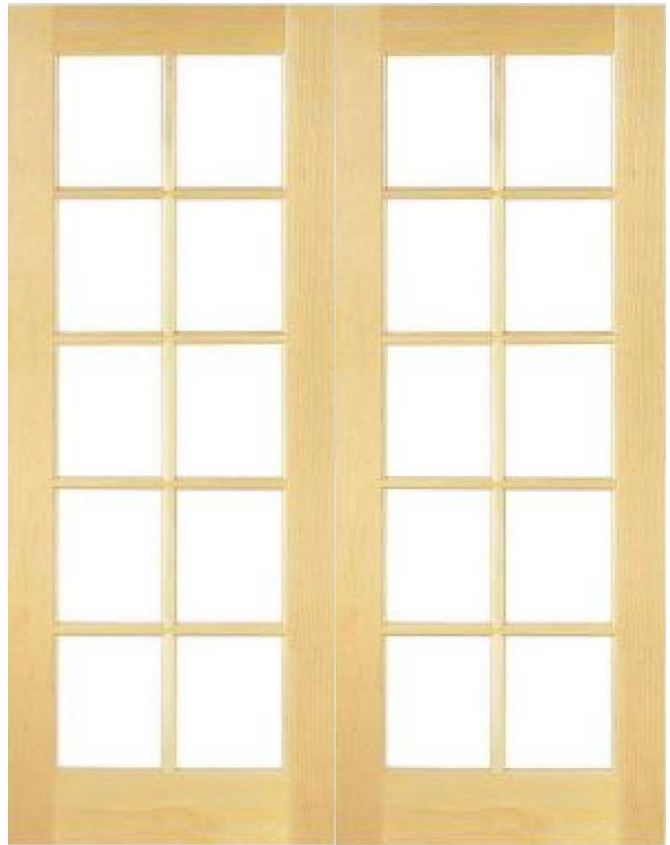

4' 20 Light Double Doors



5' & 6' 30 Light Double Doors

## Interior Door Hardware Schlage® Knobs & Levers



Brushed Nickle Lever (Standard)



Brushed Nickle Knob (Standard)



Aged Bronze Lever (Upgrade)



Aged Bronze Knob (Upgrade)

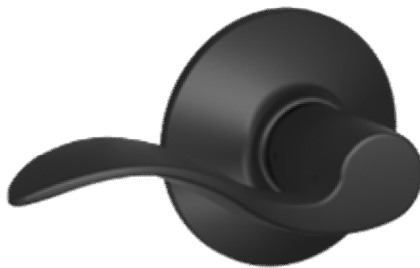

Matte Black Lever (Upgrade)



Matte Black Knob (Upgrade)



Matte Black Latitude Lever (Upgrade)

# Trim Options

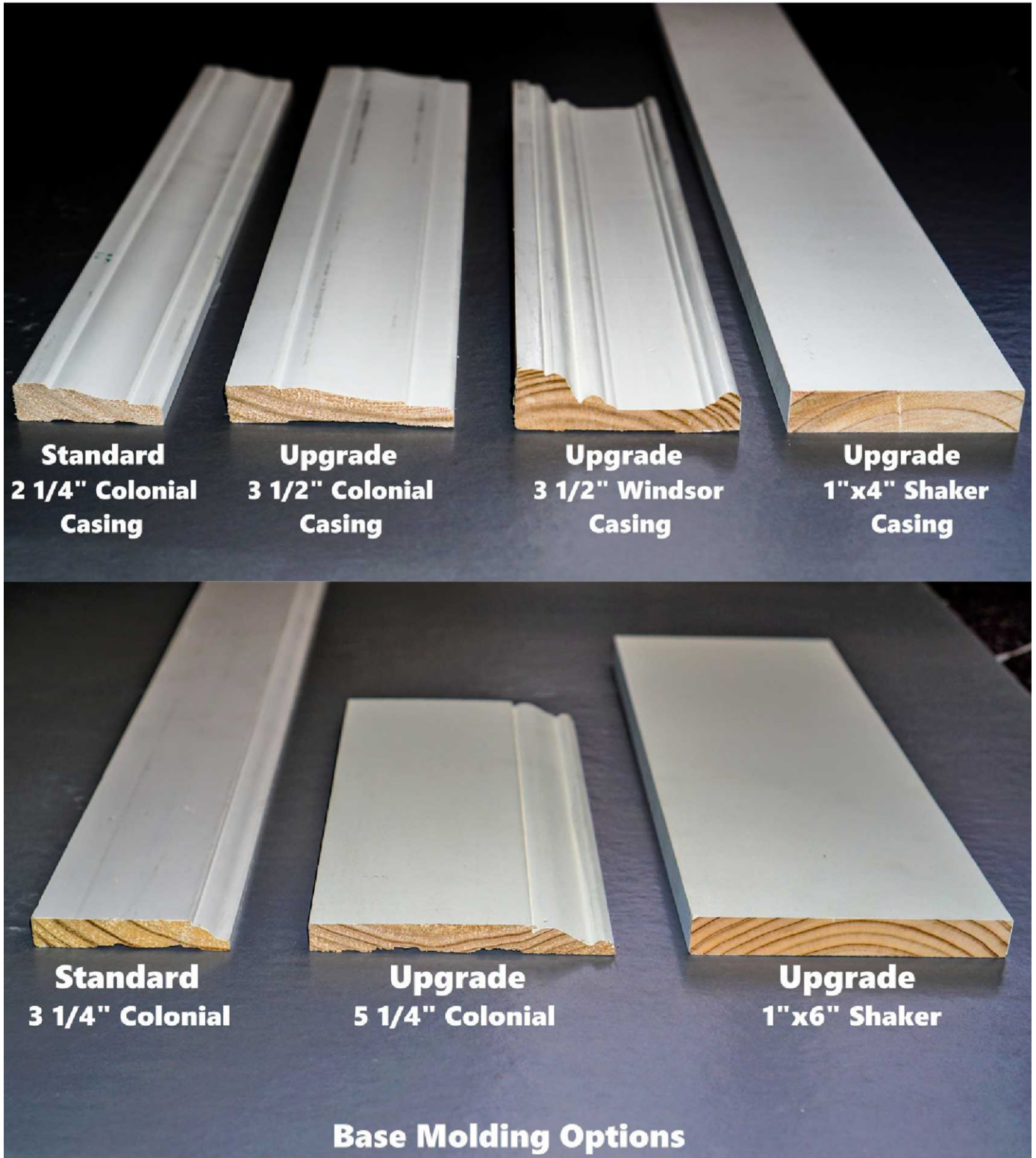



# Chair Rail



3" Chair Rail (Upgrade)

# Crown Molding



3 5/8" Crown Molding (Upgrade)



5 1/4" Crown Molding (Upgrade)

# Merillat™ Cabinets

## Classic Series

### Spring Valley Square (Standard) Oak



Group 1

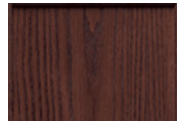

Pecan



Sable



Natural

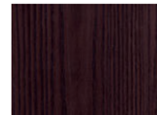

Kona

### Glen Arbor (Standard) Oak



Group 1



Pecan



Sable



Natural



Kona

# Fox Harbor Maple



Solid Drawer Front

5 Piece Drawer Front

## STAINS Group 4



Natural

Steel Grey

Sable

Dusk

Kona

Basalt

Pecan

Boardwalk

## PAINTED Group 7



PAINTED

Chiffon

Shale

Cotton

Mist

Graphite

Nightfall

## GLAZES Group 7



Chiffon w/Tuscan Glaze

Chiffon w/Desert Glaze

Mist w/Desert Glaze



Mist w/Tuscan Glaze

Graphite w/Desert Glaze

Graphite w/Tuscan Glaze

Shale w/Desert Glaze

# Fox Harbor Cherry

Group 6



Solid Drawer Front



5 Piece Drawer Front



Pecan

# Fusion Maple



## STAINS Group 4



Natural



Steel Grey



Sable



Dusk



Kona



Basalt



Pecan



Boardwalk

## PAINTED Group 7

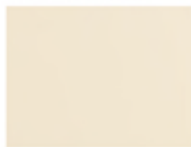

Chiffon

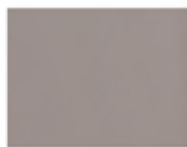

Shale

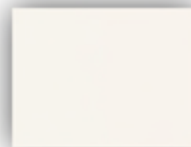

Cotton



Mist



Graphite



Nightfall



# Glen Arbor Maple



**STAINS** Group 2



Group 4

**PAINTED**



**GLAZES** Group 4



# Glen Arbor Cherry



Group 3



Pecan

# Glenrock Maple



Solid Drawer Front

5 Piece Drawer



Not A Shaker Cabinet

## STAINS

### Group 4



Natural

Steel Grey

Sable

Dusk

Kona

Basalt

Pecan

Boardwalk

## PAINTED

### Group 7



Chiffon

Shale

Cotton

Mist

Graphite

Nightfall

## GLAZES Group 7



Chiffon w/Tuscan Glaze



Chiffon w/Desert Glaze



Mist w/Desert Glaze



Mist w/Tuscan Glaze



Graphite w/Desert Glaze



Graphite w/Tuscan Glaze



Shale w/Desert Glaze

# Portrait Maple



Solid Drawer Front



5 Piece Drawer Front

## STAINS Group 4



Natural



Steel Grey



Sable



Dusk

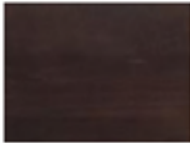

Kona



Basalt



Pecan



Boardwalk

## PAINTED Group 7

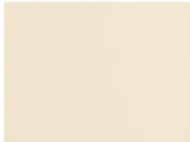

Chiffon

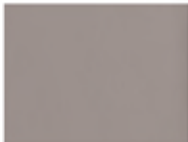

Shale

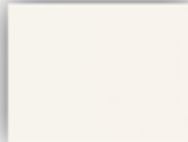

Cotton

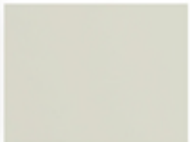

Mist



Graphite



Nightfall

# Portrait Oak



Group 3

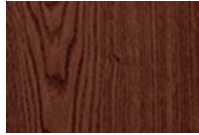

Pecan



Kona



Sable

# Portrait Cherry



Solid Drawer Front



5 Piece Drawer Front

Group 5



Pecan



# Ralston Maple



Solid Drawer Front



5 Piece Drawer Front

## STAINS Group 2



Natural



Steel Grey



Sable



Dusk



Kona



Basalt



Pecan



Boardwalk

## PAINTED Group 4



Chiffon



Shale



Cotton



Mist



Graphite



Nightfall

## GLAZES Group 4



Chiffon w/Tuscan Glaze



Chiffon w/Desert Glaze



Mist w/DesertGlaze



Mist w/ Tuscan Glaze



Graphite w/ Desert Glaze



Graphite w/Tuscan Glaze



Shale w/Desert Glaze

# Ralston Cherry

Group 3



Solid Drawer Front



5 Piece Drawer Front



Pecan

# Rowan Maple



Natural



Graphite w/ 5 pc drawer front

## STAINS Group 4



Natural



Steel Grey



Sable



Dusk



Kona



Basalt



Pecan



Boardwalk

## PAINTED Group 7



Chiffon



Shale

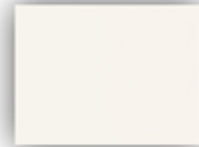

Cotton



Mist



Graphite



Nightfall

## GLAZES Group 7



Chiffon w/ Tuscan Glaze



Chiffon w/ Desert Glaze



Mist w/ Desert Glaze



Mist w/ Tuscan Glaze



Graphite w/ Desert Glaze



Graphite w/ Tuscan Glaze



Shale w/ Desert Glaze

# Rowan Cherry



Group 5



Pecan

# Seneca Ridge Maple

**STAINS Group 4**



**PAINTED Group 7**



**GLAZES Group 7**





# Seneca Ridge Cherry



Group 5



Pecan

# Seneca Ridge Oak



Group 3



Pecan



Sable



Natural



Kona

# Spring Valley Maple



## STAINS Group 2



## Group 4



## GLAZES Group 4



# Spring Valley Cherry



Group 3



Pecan

# Spring Valley Hickory



Group 2

# Tolani Maple



Solid Drawer Front



5 Piece Drawer Front

## STAINS Group 4



Natural



Steel Grey



Sable



Dusk



Kona



Basalt



Pecan



Boardwalk

## PAINTED Group 7



Chiffon



Shale

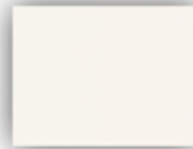

Cotton



Mist



Graphite



Nightfall

# Tolani Cherry



Solid Drawer Front



5 Piece Drawer Front

Group 6



Pecan

# Tolani Oak



Solid Drawer Front



5 Piece Drawer Front

Group 4

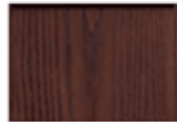

Pecan



Sable



Natural



Kona



# Vance (Laminate)

Group 2



White



Grey w/ 5 pc drawer

STANDARD

**WeatherTech®**

Auto. Home. Pet. Find Your Fit.



## SinkMat

SinkMat makes it easy to shield your kitchen and bathroom sink cabinets from costly damage. A ½" high surrounding edge contains liquids in the event of a leak or spill, while a waterproof, non-stick finish makes clean up effortless. SinkMat helps deter the formation of mold and mildew on the base and sides of your vanities, making it ideal for homes, businesses, and rental properties.

## SinkMat Highlights

- Raised edge contains under sink messes.
- Easy to trim to your kitchen or utility room sink cabinet spaces.

# Merillat™ Deluxe Cabinets



Undermount Drawer with SoftAction Drawers



Dovetail Drawer

# Merillat™ Kitchen Upgrade Options



Tilt-Out Trays for Sink



Trash Hamper

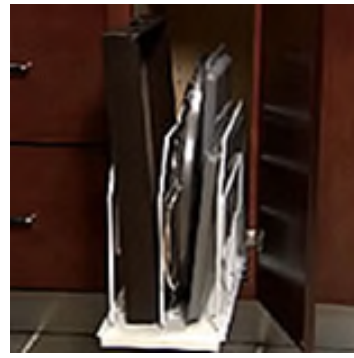

Roll-Out Tray Divider



All Plywood Construction

# Crown Molding Optional



Cove Molding



Classic Crown Molding



# Kitchen & Bath Counter Tops

## Wilsonart®

### Standard Laminate



Almond Leather 2932-60

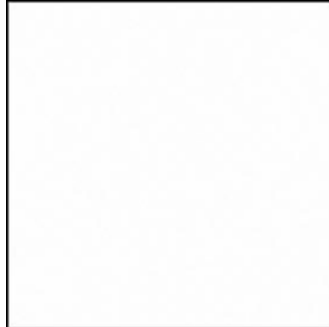

Designer White D354-60



Mystique Dawn 4762-60



Tumbled Rocca 4835-38

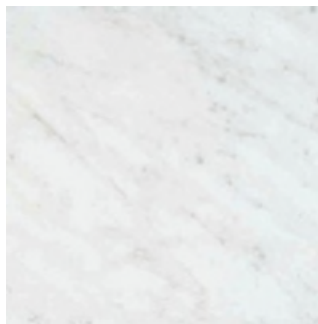

White Carrara 4924-38



Sable Soapstone 4883-38



Green Soapstone 4885-38



Pearl Soapstone 4886-38



Tan Soapstone 4887-38



Spicewood Springs 4905-38

# Upgrade Laminate



Bronze Fusion 1796-07



Calcutta Marble 4925-07



Smoky Topaz 4589-07



Jeweled Coral 4866-52

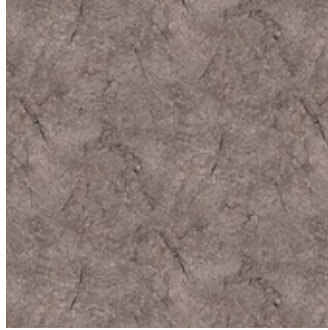

Andorra Fog 4999K-22



Italian White Di Pesco 4954K-22

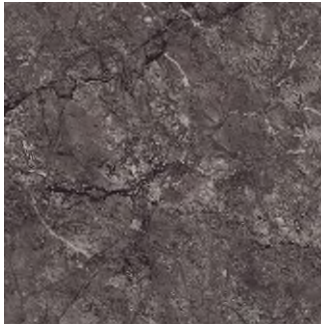

Andorra Shadow 4998K-22



Serrana 1890K-22

# Deluxe Option Laminate



Deepstar Slate 1818-35

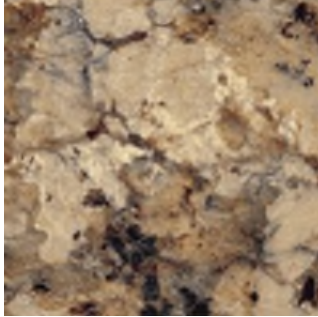

Winter Carnival 1874-35

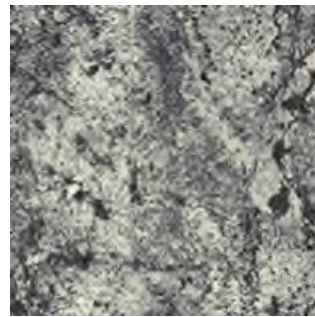

Trinidad Lapidus 1879-35



Bianco Romano 1872-35



Sedona Trail 1826-35



Summer Carnival 1875-35



Canyon Passage 1842-45

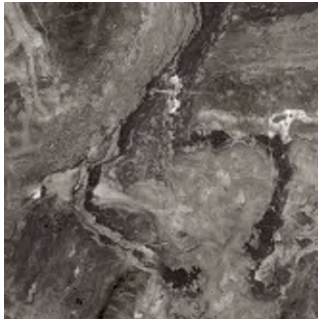

Cipollino Grigio 1882K-35



Cipollino Bianco 1881K-35



# Laminate Countertop Edging



Standard Edge

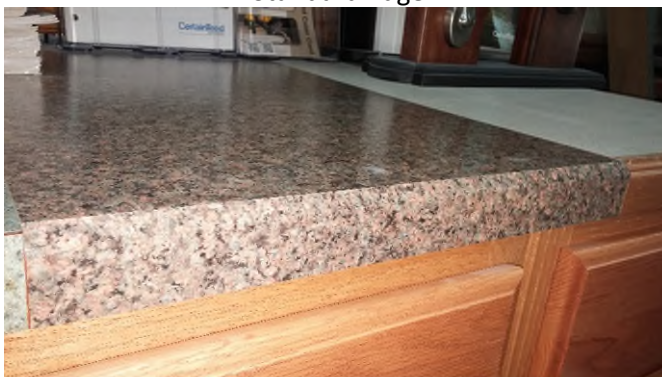

Beveled Edge- Upgrade



Milano Mahogany  
4728K-52

Crescent Edge- Upgrade



Wood Beveled Edge- Upgrade



Radius End Top



Angle Clipped Corners



# MSI® Quartz Countertops (Kitchen Only)



Arctic White

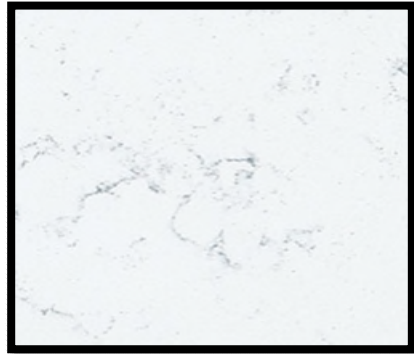

Fairy White

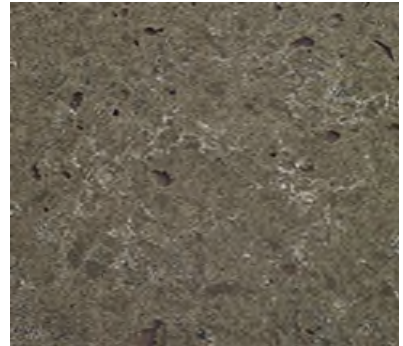

Babylon Gray

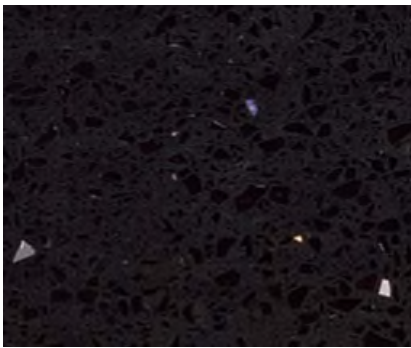

Sparkling Black



Concerto

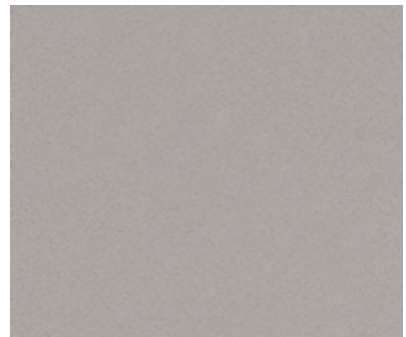

Meridian Gray



New Carrara Marmi

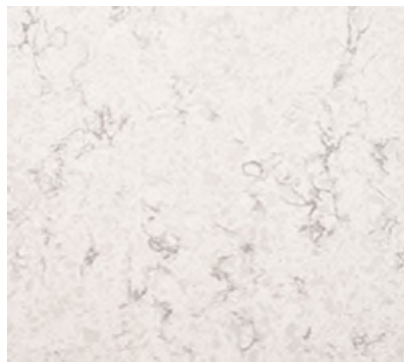

Mara Blanca



Carrara Mist



Sparkling White



Gray Lagoon

## Quartz Kitchen Sinks



SIN-18-SINBWL-3018 (Undermount)



SIN-18-DBLBWL-5050-3118 (Undermount)

# Edging Profiles



Eased



Bevel

# Kitchen Sink Options

## Stainless Steel



Double Bowl Stainless Steel Sink  
(STANDARD)

Stainless Steel Double Bowl- (Standard)



Standard 8" Deep  
Stainless Steel Sink

Stainless Steel Single Bowl- (Standard)



Stainless Steel Single Bowl Undermount Sink- (Upgrade)



Stainless Steel Double Bowl Undermount Sink- (Upgrade)

# Kitchen

## Standard



Model No: 4453-DST  
Finish: Chrome  
Linden Single Handle Kitchen Faucet with Spray

## Options



Model No: 4453-AR-DST  
Finish: Arctic Stainless  
Linden Single Handle



Model No: 9113-DST  
Finish: Chrome  
Essa Single Handle



Model No: 9113-AR-DST  
Finish: Arctic Stainless  
Essa Single Handle



Model No: 9113-RB-DST  
Finish: Venetian Bronze  
Essa Single Handle



Model No: 9113-BL-DST  
Finish: Matte Black  
Essa Single Handle



# Kitchen

## Additional Options



Model No: 1903-DST  
Finish: Chrome  
Classic Single Handle Bar/Prep



Model No: 2131LF  
Finish: Chrome  
Classic Two Handle Laundry

# Range Hoods



413001 Non-Ducted White (Standard)  
403001 Ducted White (Upgrade)



413023 Non-Ducted Black (Standard)  
403023 Ducted Black (Upgrade)



413004 Non-Ducted Stainless Steel (Upgrade)  
403004 Ducted Stainless Steel (Upgrade)

# Whirlpool® Appliances Dishwashers (Optional)



White



Black



Stainless Steel

# Microwaves (Optional)

## WMH31017A



Biscuit on Biscuit



Black on Black



Stainless Steel (Upgrade)



White on White

# Rynone<sup>®</sup> Bath Countertops Cultured Marble

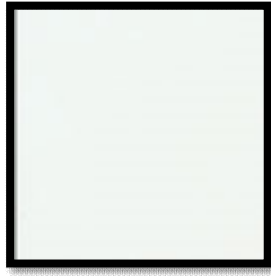

White on White CM3 Standard

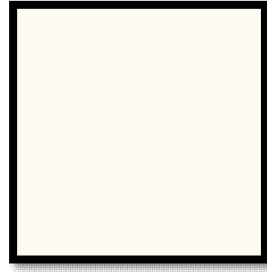

Solid White CM3B (Standard)

## Cultured Marble Granite (Upgrade)



Ecru 332



Fashion Grey 331



Sand 323

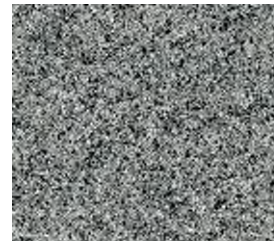

Steel Grey 325



# Granite Vanity Top (Upgrade)

## Group 1

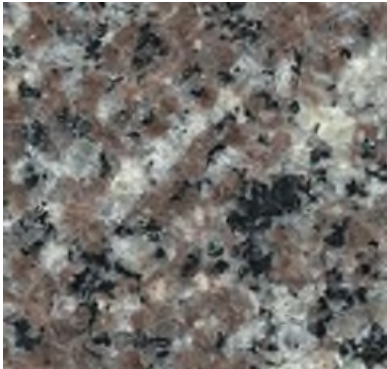

Burlywood



Wheat

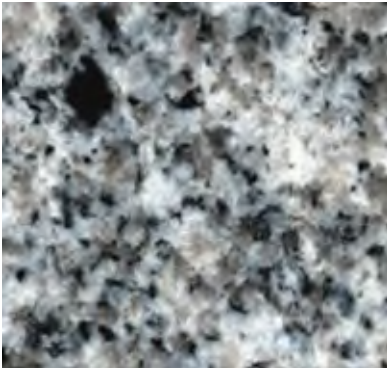

Meteorite



Tiger Skin White

## Group 2



Ubatuba



Elysian

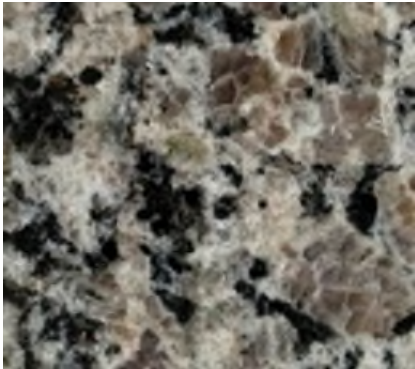

Rio Roca

## Group 3

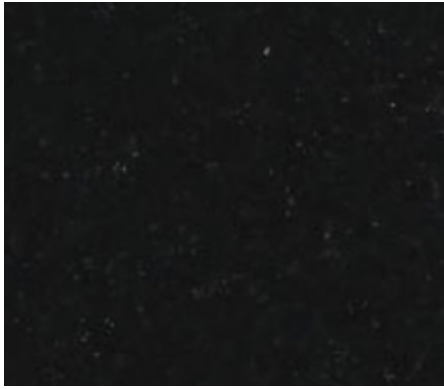

Absolute Black



Marron Desert

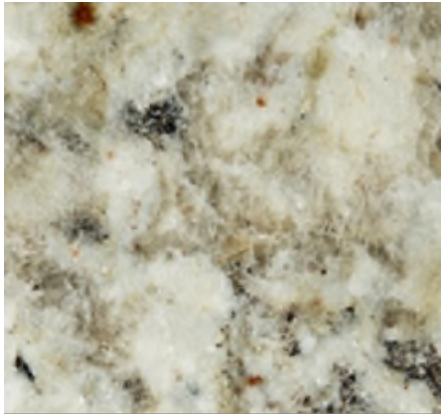

Luna Bai

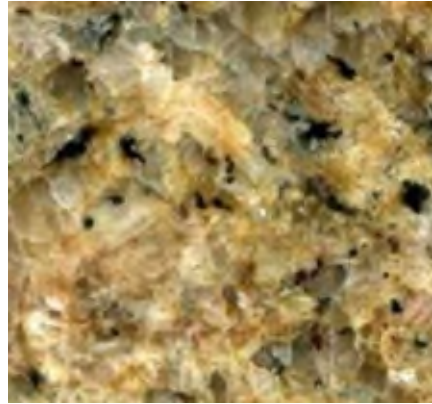

Venice Gold

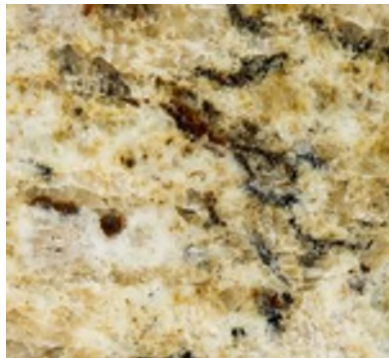

Sandstorm

# Rynone<sup>®</sup> Quartz Vanity Tops

## Group 1



Q1002 Ocean Grey



Q3001 Polar White



Q3010 Iceberg

## Group 2



Q3009 Carrara Verta

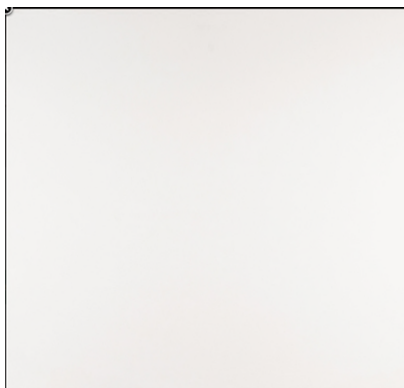

Q3007 Porcelain White

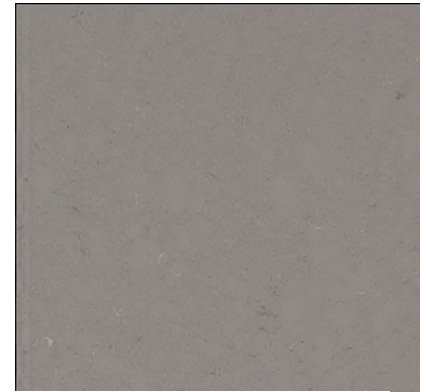

Q3012 Terra Grey



## Group 3



Q3006 Grey Pearl



Q3011 Stormy Grey

## Group 4



Q3003 White Pearl

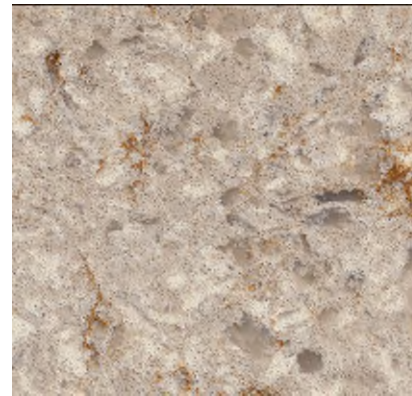

Q3013 Copper Sand

## Large Porcelain Oval Undermount Bowls

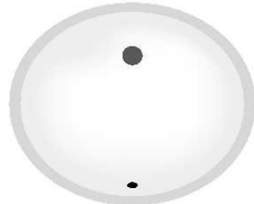

White

| Overall Size |         |       | interior Size |       |        |
|--------------|---------|-------|---------------|-------|--------|
| Length       | Width   | Depth | Length        | Width | Depth  |
| 19 1/4"      | 15 3/4" | 8"    | 17 1/4"       | 14"   | 6 1/4" |

## Porcelain Rectangular Undermount Bowls



White

| Overall Size |       |        | interior Size |       |       |
|--------------|-------|--------|---------------|-------|-------|
| Length       | Width | Depth  | Length        | Width | Depth |
| 20"          | 15"   | 7 1/2" | 18"           | 13"   | 6"    |

## Standard Bowl Placement

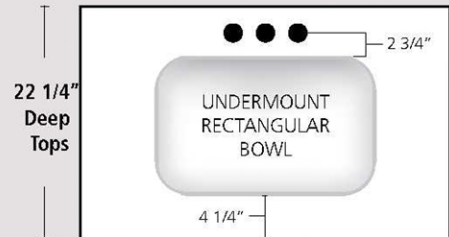
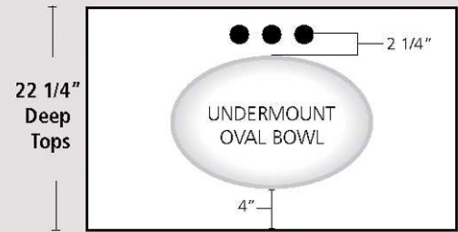

- \*Dimensions are +/- 1/8".
- \*Diameter of all faucet holes is 1 3/8".
- \*Sink cutouts are polished.

\*The printing on this page may not accurately represent the slight color variations.



# Granite Countertop Example



## Medicine Cabinets (Optional)



14" Mirrored Medicine Cabinet (Standard)



Merillat Matching Triple Mirror Medicine Cabinet (Upgrade)  
Available 24", 30", & 36"

# Vanity Lights

## Bath Collection

### Westmont -Standard



**Bath**  
**44019-05**  
Chrome Finish  
Glass Satin White  
W: 12.00" H: 8.25" E: 7.5"  
(2) Medium Base 60w  
Clear Bulb Recommended



**Bath**  
**44020-05**  
Chrome Finish  
Glass Satin White  
W: 17.00" H: 8.25" E: 8.5"  
(3) Medium Base 60w  
Clear Bulb Recommended



**Bath**  
**44021-05**  
Chrome Finish  
Glass Satin White  
W: 23.50" H: 8.00" E: 8.25"  
(4) Medium Base 60w  
Clear Bulb Recommended

### Holman -Upgrade



**Bath**  
**44806-962**  
Brushed Nickel Finish  
Glass Satin Etched  
W: 11.75" H: 9.00" E: 7.5"  
(2) Medium Base 60w  
Clear Bulb Recommended



**Bath**  
**44807-962**  
Brushed Nickel Finish  
Glass Satin Etched  
W: 18.00" H: 9.00" E: 7.25"  
(3) Medium Base 60w  
Clear Bulb Recommended



**Bath**  
**44808-962**  
Brushed Nickel Finish  
Glass Satin Etched  
W: 24.50" H: 9.00" E: 7.25"  
(4) Medium Base 60w  
Clear Bulb Recommended

## Holman -Upgrade



### Bath

**44806-782**

Heirloom Bronze Finish  
Glass Satin Etched  
W: 11.75" H: 9.00" E: 7.25"  
(2) Medium Base 60w  
Clear Bulb Recommended



### Bath

**44807-782**

Heirloom Bronze Finish  
Glass Satin Etched  
W: 18.00" H: 9.00" E: 7.25"  
(3) Medium Base 60w  
Clear Bulb Recommended



### Bath

**44808-782**

Heirloom Bronze Finish  
Glass Satin Etched  
W: 24.50" H: 9.00" E: 7.25"  
(4) Medium Base 60w  
Clear Bulb Recommended

## Catlin -Upgrade



### Bath

**4418502-112**

Midnight Black Finish  
Glass Etched/White Inside  
W: 14.25" H: 8.00" E: 6.75"  
(2) Medium Base 60w  
Clear Bulb Recommended



### Bath

**4418503-112**

Midnight Black Finish  
Glass Etched/White Inside  
W: 24.00" H: 8.00" E: 6.75"  
(3) Medium Base 60w  
Clear Bulb Recommended







### Bath

**4418504-112**

Midnight Black Finish  
Glass Etched/White Inside  
W: 33.75" H: 8.00" E: 6.75"  
(4) Medium Base 60w  
Clear Bulb Recommended

## TYPICAL\* BATH VANITY LAYOUTS

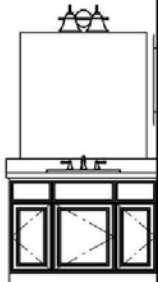
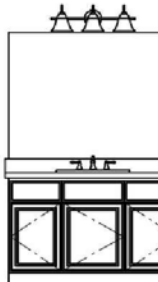
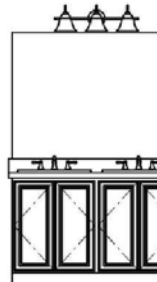
MERRILLAT CLASSIC SERIES - VANITIES AND DRESSING TABLES

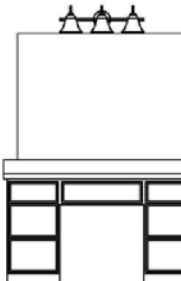
|  |   |   |
|--|---|---|
|         |    |                              |
| <p><b>V-24 (VB24)**</b><br/>24" x 36" Mirror<br/>2-Bulb Tulip Light</p>                  | <p><b>V-30 (VB30)</b><br/>30" x 36" Mirror with MG14<br/>2-Bulb Tulip Light</p>     | <p><b>V-36 (VB36)</b><br/>36" x 36" Mirror with MG14<br/>2-Bulb Tulip Light</p>                                 |
|        |   |                             |
| <p><b>V-42 (VSB42-2D)</b><br/>36" x 36" Mirror with MG14<br/>2-Bulb Tulip Light</p>      | <p><b>V-48 (VSB48-2D)</b><br/>48" x 36" Mirror with MG14<br/>3-Bulb Tulip Light</p> | <p><b>V-48 Double Bowl** or<br/>Offset Single Bowl (2-VB24)</b><br/>48" x 36" Mirror<br/>3-Bulb Tulip Light</p> |
|       | <p style="font-size: small;">Wall or<br/>More<br/>Cabinets</p>                      |                            |
| <p><b>36" Dressing Table (VD12 AD24)</b><br/>36" x 36" Mirror<br/>2-Bulb Tulip Light</p> |   | <p><b>54" Dressing Table (2-VD15 AD24)</b><br/>48" x 36" Mirror<br/>3-Bulb Tulip Light</p>                      |

\*NOTE - Typical layouts are for standard laminate tops. Layouts may vary with cultured marble or corian tops.

\*\*NOTE - There must be 15" clearance from the center of a sink to a wall or any other object.

Therefore, V24 and V48 double-bowl vanities cannot be located against a wall on either side.



# TYPICAL\* BATH VANITY LAYOUTS

## MERRILLAT CLASSIC SERIES - VANITIES AND DRESSING TABLES

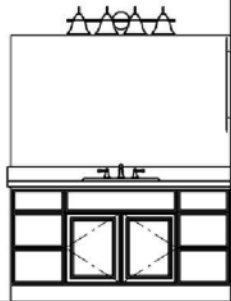

V-60 (VCD60)

60" x 36" Mirror with MC14  
4-Bulb Tulip Light

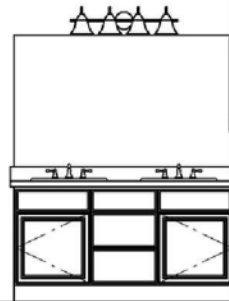

V-60 Double Bowl (VSB60-3D)

(2) 24" x 36" Mirrors with MC14  
(2) 2-Bulb Tulip Lights

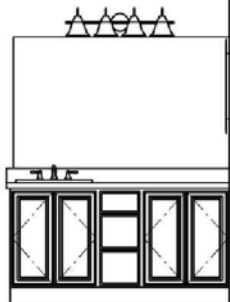

V-60 Offset Single Bowl (2-VB24 VD12)

60" x 36" Mirror with MC14  
4-Bulb Tulip Light

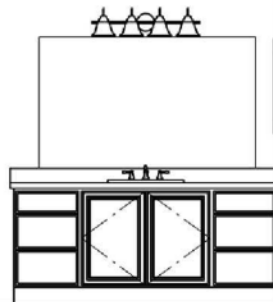

V-12 (2-VD18 VB36)

60" x 36" Mirror with MC14  
4-Bulb Tulip Light

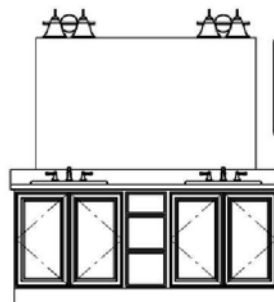

V-12 Double Bowl or Offset Single Bowl (2-VB30 VD12)

(2) 30" x 36" Mirrors with MC14  
(2) 2-Bulb Tulip Lights

\*NOTE - Typical layouts are for standard laminate tops. Layouts may vary with cultured marble or corian tops.

# Bath Fans

Broan® A70L  
(Standard)



# MODELS A50L, A70L INVENT™ SERIES FAN / LIGHTS

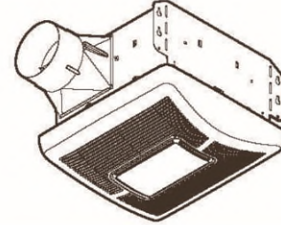

### DESCRIPTION

#### BLOWER:

- Plug-in, permanently lubricated motor - engineered for continuous operation
- Dynamically balanced centrifugal blower wheel for quiet, efficient performance
- Low RPM for quiet operation

#### HOUSING:

- Rugged, 26 gauge, galvanized steel construction
- Polymeric, 4" duct connector with tapered sleeve and no metallic clatter
- 5-3/4" height allows for 2" x 6" ceiling installations
- Sturdy, easy, four-point mounting directly to joist
- Can be mounted in ceilings up to 7/12 pitch

#### GRILLE:

- Polymeric construction
- Innovative design - the result of extensive research with designers and consumers
- 100W max. incandescent A19 type bulb or energy efficient equivalent bulb with Maximum Overall Length (M.O.L.) of 4.4" or less (bulb not included)
- Durable steel reflector with white enamel finish

#### CONTROLS (Purchase separately):

- Refer to Broan's catalog for a complete line of accessories to effectively adapt these fans to your construction requirements.

U.L. Listed for use over bathtubs and showers when connected to a GFCI protected branch circuit (ceiling mount only).

U.L. Listed for use in insulated ceilings (TYPE I.C.)

1-Year Warranty

### TYPICAL SPECIFICATION

Fan / Light shall be Broan Model A50L (A70L).

Fan / Light shall have corrosion resistant galvanized steel housing with four-point mounting capability. It shall be ducted to a roof or wall cap using 4" round ductwork.

Blower assembly shall be removable, have a centrifugal-type blower wheel and a permanently lubricated motor designed for continuous operation.

Non-metallic damper/duct connector shall be included.

Bulb shall be 100W max. A19 type incandescent or energy efficient equivalent bulb with Maximum Overall Length (M.O.L.) of 4.4" or less (bulbs not included).

Air delivery shall be no less than the airflow values and no greater than the sound level values listed in the HVI Performance Specifications provided in this specification (see following chart). All air and sound ratings shall be certified by HVI.

Ceiling Ventilator shall be U.L. Listed for use in insulated ceilings (Type I.C.) and for use over bathtubs and showers when connected to a GFCI protected branch circuit.



Broan-NuTone LLC Hartford, Wisconsin www.broan.com 800-558-1711

| REFERENCE | QTY. | REMARKS | Project      |           |
|-----------|------|---------|--------------|-----------|
|           |      |         | Location     | Architect |
|           |      |         | Engineer     |           |
|           |      |         | Contractor   |           |
|           |      |         | Submitted by | Date      |

# Panasonic® FV-08-10VSSL1 WhisperValue® DC™ Fan/Light, Pick-A-Flow™ (Upgrade)



## KEY FEATURES

- Revolutionary ECM motor with SmartFlow™ technology for optimum CFM output
- Pick-A-Flow™ Airflow Selector – one fan, you choose the CFM (80 or 100 CFM)
- Incorporates one 10W dimmable LED chip panel with <1W LED night light for warm, energy efficient illumination (night light must be wired separately)
- Built-in multi-speed control for ASHRAE 62.2 continuous ventilation compliance
- Elegant grille design compliments the aesthetics of any bathroom

# Bath

## Lavatory

### Standard



Model No: 2532LF-MPU  
Finish: Chrome  
Woodhurst Two Handle Centerset

### Options



Model No: 2532LF-SSMPU  
Finish: Stainless  
Woodhurst Two Handle Centerset



Model No: 2538-SSMPU-DST  
Finish: Stainless  
Lahara Two Handle Centerset



Model No: 2564-SSMPU-DST  
Finish: Stainless  
Ashlyn Two Handle Centerset



Model No: 2532LF-RBMPU  
Finish: Venetian Bronze  
Woodhurst Two Handle Centerset



Model No: 2538-RBMPU-DST  
Finish: Venetian Bronze  
Lahara Two Handle Centerset



Model No: 2564-RBMPU-DST  
Finish: Venetian Bronze  
Ashlyn Two Handle Centerset



# Bath

Lavatory

## Options



Model No: 2564-MPU-DST  
Finish: Chrome  
Ashlyn Two Handle Centerset



Model No: 2564-BLMPU-DST  
Finish: Matte Black  
Ashlyn Two Handle Centerset

## Available in 8" Spread



Woodhurst Two Handle Widespread  
Model No.: 3532LF



Lahara Two Handle Widespread  
Model No.: 3538



Ashlyn Two Handle Widespread  
Model No.: 3564

# Bath Accessories Chrome



Towel Ring



Towel Bar



Paper Holder

# Satin Nickle



Towel Ring



Towel Bar



Paper Holder

# Dark Bronze



Towel Ring



Towel Bar



Paper Holder

# Matte Black



Towel Ring



Towel Bar



Paper Holder



# Bath Fixture Options

## American Standard® Toilets



Low Flow Water Saving (White Only) – (Standard)  
(1.28 gpf) (15" Height off Floor)



Elongated Right-Height Water Closet w/Seat- (Upgrade)  
(1.28 gpf) (16 ½" Height off Floor)

## Pedestal Sinks



Pedestal Sink (Standard)

## Bath Fixture Color Options



White

# Tubs & Showers



48" Shower (Standard)  
48" x 35" x 72"  
Towel Bar not Incl.



36" Shower (Optional)  
36" x 36" x 72"



60" Shower (Optional)  
60" x 35" x 72"  
Towel Bar not Incl.



Cambridge Americast Tub (Upgrade)  
60" x 32" X 17-3/4"



Neo Angle Corner Shower (Optional)  
38" x 38" x 72"



60" Tub/Shower (Standard)  
60" x 32" x 72" Towel Bar not Incl.

## Bath Fixture Color Options



White

## Cadet Freestanding Tub (Option)



Part # 2764.014M202

Tub Filler Available in Chrome & Brushed  
Nickel

# Full ADA Tub & Shower Stalls



36" Full ADA Shower  
1363-BFS-ADA



60" Full ADA Shower  
1603-BFSD-ADA



60" Full ADA Tub  
2603-SMTE-ADA

# Reinforced Tub and Shower Stalls

(Stall only does not include seat, grab bars, and hand shower)



36" Reinforced (**Shower Stall Only**)  
1363-BFS



60" Reinforced (**Shower Stall Only**)  
1603-BFSD



60" Reinforced (**Tub-Shower Stall Only**)  
2603-SME



# Bath

## Tub/Shower

### Standard



Model No: T13420-SOS  
Finish: Chrome  
Classic Monitor 13 Series

### Options



Model No: T14438-SOS  
Finish: Chrome  
Lahara Monitor 14 Series



Model No: T14438-SSSOS  
Finish: Stainless  
Lahara Monitor 14 Series



Model No: T14438-RBSOS  
Finish: Venetian Bronze  
Lahara Monitor 14 Series



Model No: T14494-SOS  
Finish: Chrome  
Linden Monitor 14 Series



Model No: T14494-SSSOS  
Finish: Stainless  
Linden Monitor 14 Series



Model No: T14494-RBSOS  
Finish: Venetian Bronze  
Linden Monitor 14 Series

# Bath

## Tub/Shower

### Options



Model No: T14464  
Finish: Chrome  
Ashlyn Monitor 14 Series



Model No: T14464-SS  
Finish: Stainless  
Ashlyn Monitor 14 Series



Model No: T14464-RB  
Finish: Venetian Bronze  
Ashlyn Monitor 14 Series



Model No: T14464-BL  
Finish: Matte Black  
Ashlyn Monitor 14 Series

# Whirlpool® Hydro Massage & Soaking Tubs (Upgrade)



6032 Skirted



7242 Drop-In Oval



6060 Drop-In

## Color Options



White

# Bath

## Roman Tub

### Standard



Model No: T2738  
Finish: Chrome  
Lahara Roman Tub

### Options



Model No: T2738-SS  
Finish: Stainless  
Lahara Roman Tub



Model No: T2794-SS  
Finish: Stainless  
Linden Roman Tub



Model No: T2764-SS  
Finish: Stainless  
Ashlyn Roman Tub



Model No: T2738-RB  
Finish: Venetian Bronze  
Lahara Roman Tub



Model No: T2794-RB  
Finish: Venetian Bronze  
Linden Roman Tub



Model No: T2764-RB  
Finish: Venetian Bronze  
Ashlyn Roman Tub

# Bath

## Roman Tub

### Options



Model No: T2764-BL  
Finish: Matte Black  
Ashlyn Roman Tub

# Bath

## Additional Options



Model No: 52001-DS  
Finish: White  
Universal Slide Bar Hand Shower (ADA Compliant)



Model No: 58480-PK  
Finish: Chrome  
H2Okinetic In2ition 5-Setting



Model No: RP52688  
Finish: Chrome  
H2Okinetic 3-Setting Raincan



## Mustee® Laundry/Utility Tubs



17F  
H:34" W:23" D:23 ½"

## Mustee® Utility Sink



10  
Depth to Drain: 13"  
Overall Size: 22" x 25" x 13-3/4"

# Exterior Siding Selections

## MainStreet (WMH Stock Colors) Standard



Colonial White



Desert Tan



Sterling Gray



Heritage Cream



Cypress



Natural Clay

# MainStreet (WMH Non-Stock Colors)

## Upgrade

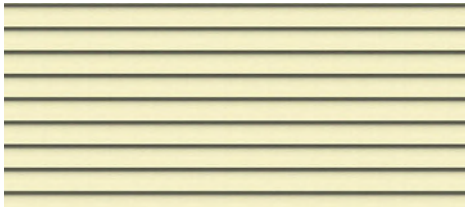

Autumn Yellow



Granite Gray



Herringbone



Savannah Wicker



Snow



Sandstone Beige



Castle Stone



Oxford Blue



Seagrass

# Mainstreet Deluxe (Upgrade)

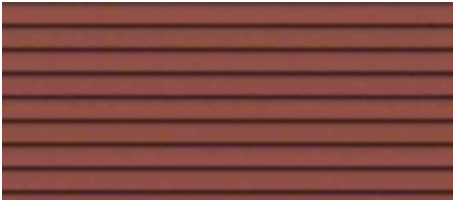

Autumn Red



Charcoal Gray



Flagstone

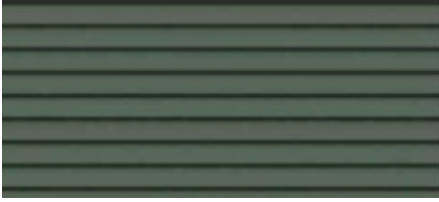

Forest



Hearthstone



Pacific Blue



Sable Brown



Spruce

# Monogram (Upgrade)



Weathered Wood

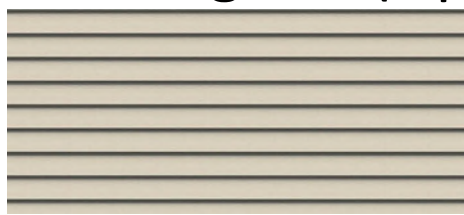

Desert Tan

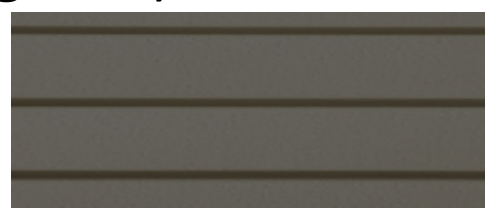

Smoky Gray



Colonial White



Cypress



Sterling Gray



Granite Gray

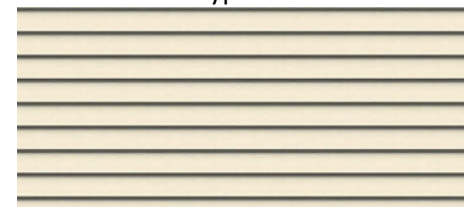

Heritage Cream



Castle Stone

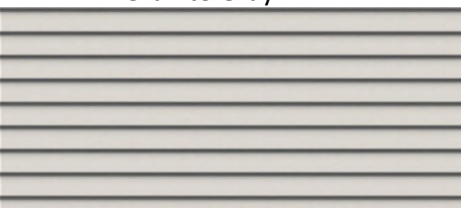

Herringbone



Light Maple



Sandstone Beige



Natural Clay



Oxford Blue



Seagrass



Savannah Wicker



Wedgewood Blue

# Monogram Deluxe Colors (Upgrade)



Charcoal Gray



Flagstone

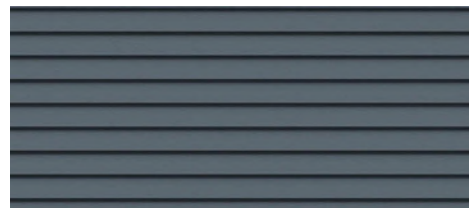

Pacific Blue



Midnight Blue



Autumn Red



Brownstone

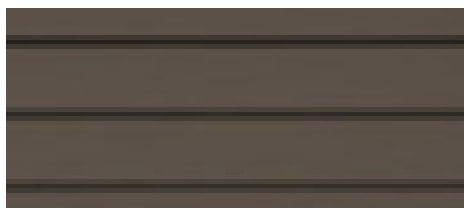

Espresso

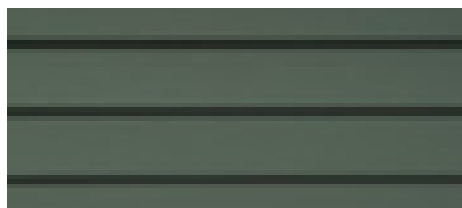

Forest



Hearthstone

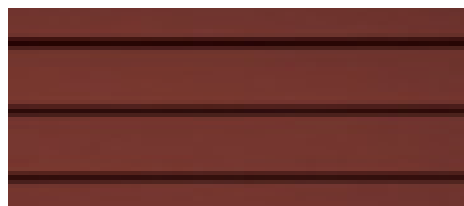

Melrose



Spruce

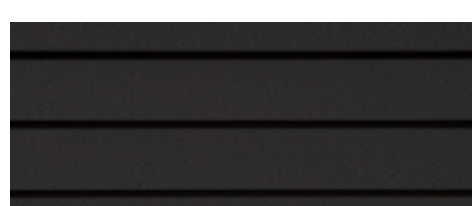

Tuxedo

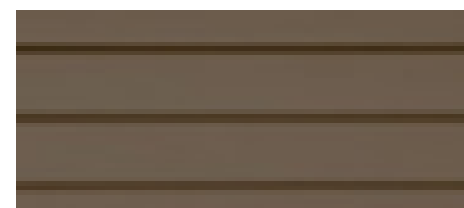

Sable Brown

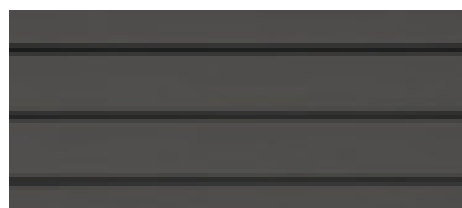

Slate



Olive Grove



# Monogram Premium (Upgrade)



Arbor Blend

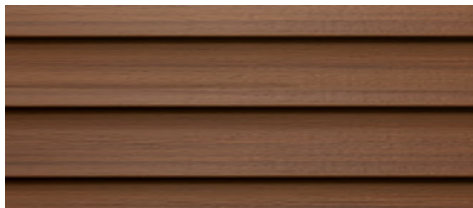

Cedar Blend

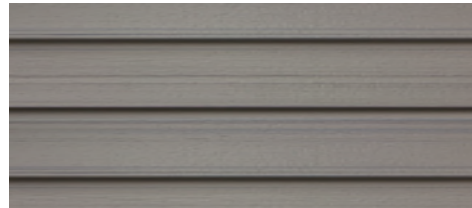

Driftwood Blend



Frontier Blend



Natural Blend



Rustic Blend



Weathered Blend

# Northwoods (Upgrade)



Sable Brown



Colonial White



Sandstone Beige



Cypress



Desert Tan



Flagstone



Granite Gray



Natural Clay

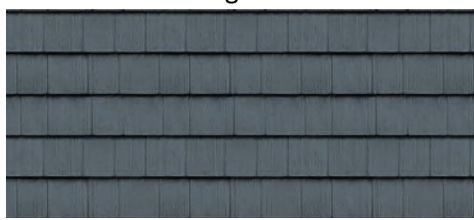

Pacific Blue



Savannah Wicker



Sterling Gray



Autumn Red

# Corner Posts



5" Snap on Corner White Only (Standard)

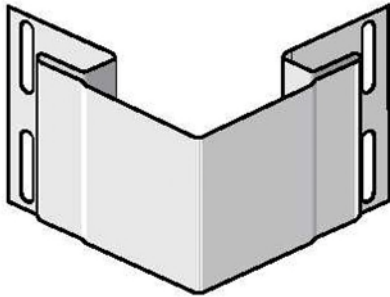

Monogram 3 1/2" Nail-On Corner (Upgrade)  
(All Available Siding Colors Available to Match)

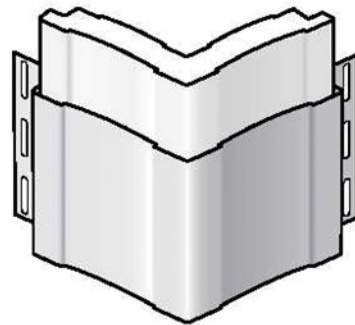

5" Smooth Super Corner (Upgrade)

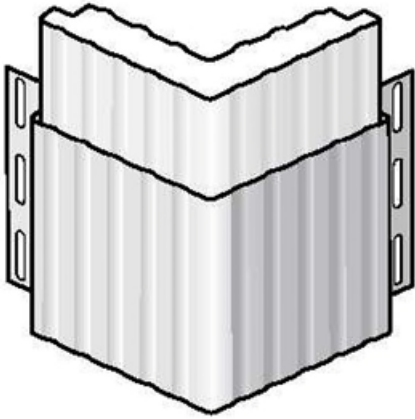

Fluted 5 1/2" Super Corner (Upgrade)

# Ply Gem® Shutters

## Louvered or Panel



White #11



Black #33



Gray #16



Brown #59



Green #55



Vineyard Red SK



Blue #41



# TruDefinition® Duration® Shingles

## Standard Colors



Brownwood

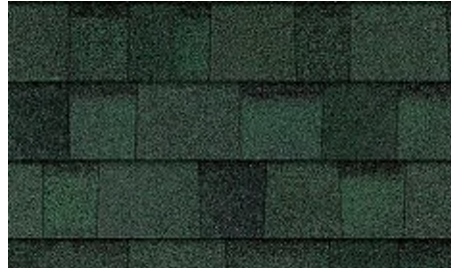

Chateau Green



Terra Cotta



Driftwood



Estate Gray

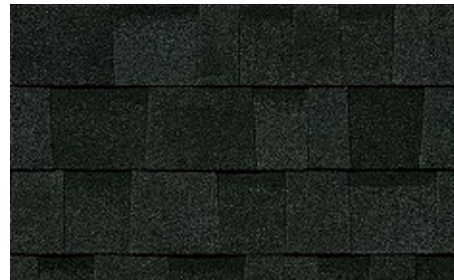

Onyx Black



Sierra Gray



Teak



# Non-Stock Colors (Upgrade)



Colonial Slate



Harbor Blue



Slatestone Gray



Desert Rose



Midnight Plum



Sand Castle



Williamsburg Gray

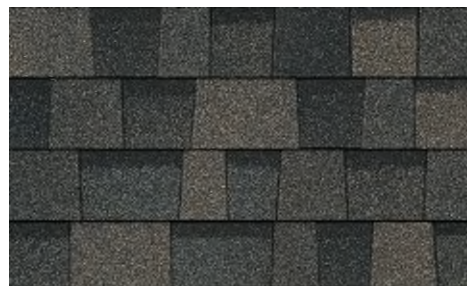

Peppercorn

# Designer Colors (Upgrade)



Pacific Wave



Sand Dune



Storm Cloud



Summer Harvest



Merlot



Aged Copper



Sedona Canyon



# Exterior Options

## PVC Picture Frame (Upgrade)



## FYPON® Architrave



38"W X 41 1/2"OW X 6"H X 3"P CROSSHEAD

---