

 /eksadobuy

 /eksadoburada

 /eksado



AHŞAP EV  
TINY HOUSE  
ŞAŞI-KARKAS

[www.eksado.com](http://www.eksado.com)



Kozluk Mahallesi D-100 Yanyol Cad.  
No.12 Erenler / Sakarya / Türkiye



+90 533 307 75 86



info@eksado.com  
www.eksado.com





EKOLOJİK  
SAĞLAM  
DOĞAL  
AHŞAP ÜRÜNLER

## EKSADO

EKSADO ismini Ekolojik, Sağlam, Doğal kelimelerinin baştaki harflerinin birleşmesinden almıştır. Yerleşkemiz Türkiye Sakarya'da bulunmaktadır.

10.000 m<sup>2</sup> fabrikamızın içerisinde 70 kişinin üzerinde iş gücü ile üretim yapmaktayız. Bu kadronun içerisinde Mimar, Mühendis ve çok değerli ustalar bulunmaktadır. Kurulduğunda doğal ahşap ev imalatı ile başlayan şirketimizde şuan ağırlıklı olarak Tiny house üretimi yapılmaktadır. Güçlü teknik kadrosu ve işinin erbabı ustaları ile Türkiye sektöründe lider konumda yer alıyoruz.

Her ay tam kapasite çalışan ve gün geçtikçe kendini katlayarak ilerleyen fabrikamızda ayda 35 adet Tiny House üretme kapasitesine sahibiz. Üstelik mevcut modellerin yanı sıra kişiye özel tasarımlarla da sektörde fark yaratmaya devam ediyoruz.

Yurtiçi ve yurtdışı bitirdiğimiz ve devam ettiğimiz projelerin her biri referans niteliğinde ve gurur duyduğumuz işlerdir. Kalite odaklı ilerleyişimiz sayesinde güven ve doğru adresin adıdır aslında EKSADO.

## VİZYON

Değişen dünyanın taleplerine hizmet eden bir şirket olarak niyetimiz bu dünyaya gülen yüzler kazandırmaya devam etmektir.

Bunu da ancak yarınlarımız gördüğümüz çocuklara ve gelecek nesillere daha güzel bir dünya bırakarak olacağını iyi biliyoruz.

Bu yüzden ki doğadan ilham alıyoruz ve doğal olanı kullanıyoruz. Yaptığımız ürünlerle doğasever müşterilerimizi doğaya kazandırmak istiyoruz. Çünkü doğanın değerini en çok onun bir parçası olabilen insanların anlayacağına inanıyoruz.

EKSADO ailesi olarak bu hedefler doğrultusunda tüm dünyada birçok doğasever müşterimiz ile geçmişte olduğu gibi gelecekte de birçok gülen yüzün sebebi olmak istiyoruz.

# MICASA MODEL



## MICASA ÇİFT LOFT / 8 m

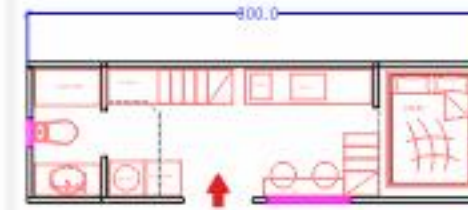
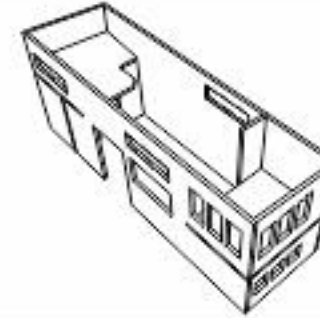
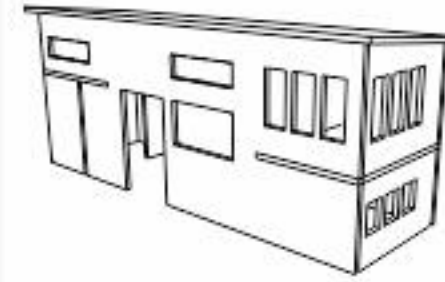

ZEMİN KAT PLANI

LOFT KAT PLANI

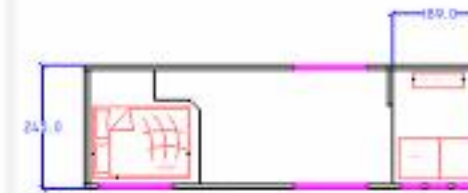

<b>NET KULLANIM ALANI</b>	28,5 m <sup>2</sup>
<b>SINIFI</b>	O2 TİPİ ONAY BELGELİ
<b>ŞAŞI</b>	3-5 mm DALDIRMA GALVANİZ S420 MC ÇELİK
<b>DİNGİL</b>	ÇİFT FRENLİ TORSİYONLU
<b>KAPLIN</b>	KNDOT MARKA
<b>KARKAS</b>	0,8mm kalınlıkta 90x45 mm EBATINDA HAFIF ÇELİK
<b>ÇATI KAPLAMASI</b>	0,5 mm SİNÜS METAL
<b>YALITIM</b>	50 dns MİNERAL TAŞYONU / 8 cm
<b>NEH BARIYERİ</b>	TYVEK
<b>DIŞ CEPHE AHŞAP KAPLAMASI</b>	KUZEY ÇAMI THERMOWOOD
<b>DIŞ CEPHE METAL KAPLAMASI</b>	0,5 mm KENET METAL
<b>DIŞ CEPHE DİĞER KAPLAMASI</b>	-
<b>İÇ CEPHE DUVAR KAPLAMASI</b>	LADIN LAMBRI 18 mm
<b>İÇ CEPHE ZEMİN</b>	SANDVIÇ PANEL 45 mm + LAMİNANT
<b>İÇ CEPHE TAVAN</b>	LADIN LAMBRI 18 mm
<b>BANYO DUVAR</b>	BOARDEX + CTP DECOPAN
<b>BANYO ZEMİN</b>	BOARDEX + CTP DECOPAN
<b>BANYO TAVAN</b>	THERMOWOOD
<b>ELEKTRİK TESİSATI</b>	3x2,5/3x1,5/3x6 YANMAZ BORU HATLI HALDJENFREE KABLO
<b>MUTFAK VE BANYO DOLAPLARI</b>	MDFLAM VE ÇAM MASIF PANEL
<b>MUTFAK VE BANYO TEZGAHI</b>	ÇAM MASIF PANEL 20 mm + TİCK YAĞI
<b>MERDİVEN ALTI DOLAPLARI</b>	MDFLAM
<b>MERDİVEN BASAMAKLARI</b>	ÇAM MASIF PANEL 20 mm + TİCK YAĞI
<b>İÇ AYDINLATMA</b>	SPOT / AVIZE
<b>DIŞ AYDINLATMA</b>	SPOT
<b>DOĞRAMA</b>	PVC BEYAZ
<b>CAM</b>	4+16+4 ISICAM
<b>İÇ KAPI</b>	MDF PANEL KAPI
<b>AKILLI EV TEKNOLOJİSİ</b>	OPSIYONEL
<b>SOLAR ENERJİ SİSTEMİ</b>	OPSIYONEL
<b>ELEKTRİKLİ YERDEN ISITMA</b>	OPSIYONEL
<b>VERANDA</b>	-
<b>İÇ DONATI</b>	MINİ BUZDOLABI + MINİ FIRIN + İKİLİ OCAK + MINİ ÇAMAŞIR MAKİNESİ + BOİLER + TV + KLİMA + PUF + KATLANIR KOLTUK + YATAK

# LOS ANGELES MODEL



## LOS ANGELES TEK LOFT / 9 m

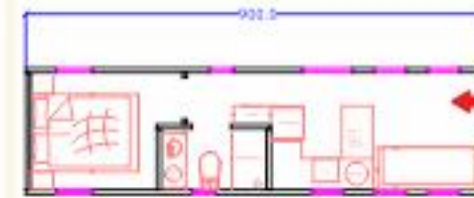
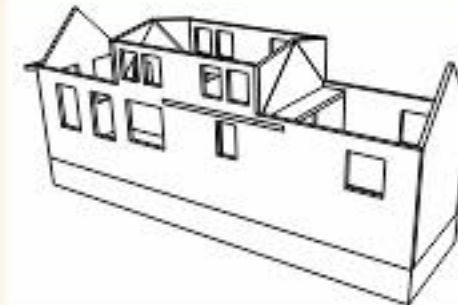

ZEMİN KAT PLANI



LOFT KAT PLANI

<b>NET KULLANIM ALANI</b>	28,0 m <sup>2</sup>
<b>SINIFI</b>	O2 TİPİ ONAY BELGELİ
<b>ŞASI</b>	3-5 mm DALDIRMA GALVANİZ S420 MC ÇELİK
<b>DİNGİL</b>	ÇİFT FRENLI TORSİYONLU
<b>KAPLIN</b>	KNOOT MARKA
<b>KARKAS</b>	0,8mm kalınlıkta 90x45 mm EBATINDA HAFİF ÇELİK
<b>ÇATI KAPLAMASI</b>	0,5 mm KENET METAL
<b>YALITIM</b>	550 dns MINERAL TAŞYÜNÜ / 8 cm
<b>NEH BARIYERİ</b>	TYVEK
<b>DIŞ CEPHE AHŞAP KAPLAMASI</b>	BOYALI LADİN LAMBRI 16 mm
<b>DIŞ CEPHE METAL KAPLAMASI</b>	0,5 mm KENET METAL
<b>DIŞ CEPHE DİĞER KAPLAMASI</b>	-
<b>İÇ CEPHE DUVAR KAPLAMASI</b>	LADİN LAMBRI 16 mm + KİSMİ DEKORATİF LAMBRI
<b>İÇ CEPHE ZEMİN</b>	SANDVIÇ PANEL 45 mm + LAMİNANT + YERDEN ISITMA
<b>İÇ CEPHE TAVAN</b>	LADİN LAMBRI 16 mm
<b>BANYO DUVAR</b>	BOARDEX + CTP DECOPAN
<b>BANYO ZEMİN</b>	BOARDEX + CTP DECOPAN
<b>BANYO TAVAN</b>	BOARDEX + CTP DECOPAN
<b>ELEKTRİK TESİSATI</b>	3x2.5/3x1.5/3x6 YANMAZ BORU HATLI HALDJENFREE KABLO
<b>MUTFAK VE BANYO DOLAPLARI</b>	MDFLAM
<b>MUTFAK VE BANYO TEZGAHI</b>	ÇAM MASIF PANEL 20 mm + TİCK YAĞI
<b>MERDİVEN ALTI DOLAPLARI</b>	-
<b>MERDİVEN BASAMAKLARI</b>	TIRMANMA TİPİ MERDİVEN
<b>İÇ AYDINLATMA</b>	SPOT
<b>DIŞ AYDINLATMA</b>	DUVAR TİPİ APLİK
<b>DOĞRAMA</b>	PVC ANTRASİT
<b>CAM</b>	4+16+4 ISICAM
<b>İÇ KAPI</b>	MDF PANEL KAPI
<b>AKILLI EV TEKNOLOJİSİ</b>	OPSİYONEL
<b>SOLAR ENERJİ SİSTEMİ</b>	OPSİYONEL
<b>ELEKTRİKLİ YERDEN ISITMA</b>	MEVCUT
<b>VERANDA</b>	-
<b>İÇ DONATI</b>	BUZDOLABI + MINİ FIRIN + MINİ ÇAMAŞIR MAKİNESİ + MINİ BULAŞIK MAKİNESİ + İKİLİ OCAK + BOİLER + TV + KLİMA + KOLTUK + YATAK

# CALIFORNIA<sub>MODEL</sub>



## CALIFORNIA TEK LOFT / 9 m

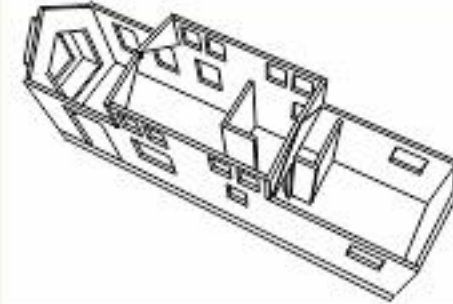

ZEMİN KAT PLANI

LOFT KAT PLANI

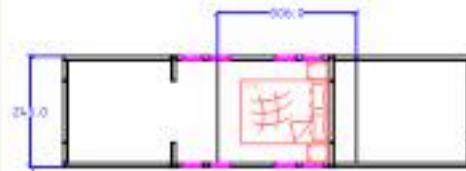

<b>NET KULLANIM ALANI</b>	29,8 m <sup>2</sup>
<b>SINIFI</b>	O2 TİPİ ONAY BELGELİ
<b>ŞASI</b>	3-5 mm DALDIRMA GALVANİZ S420 MC ÇELİK
<b>DİNGİL</b>	ÇİFT FRENLİ TORSİYONLU
<b>KAPLİN</b>	KNOOT MARKA
<b>KARKAS</b>	0,8mm kalınlıkta 90x45 mm EBATINDA HAFİF ÇELİK
<b>ÇATI KAPLAMASI</b>	0,5 mm KENET METAL
<b>YALITIM</b>	50 dns MİNERAL TAŞYÜNÜ / 8 cm
<b>NEH BARIYERİ</b>	TYVEK
<b>DIŞ CEPHE AHŞAP KAPLAMASI</b>	BOYALI LADİN LAMBRI 16 mm
<b>DIŞ CEPHE METAL KAPLAMASI</b>	0,5 mm TRAPEZ METAL
<b>DIŞ CEPHE DİĞER KAPLAMASI</b>	-
<b>İÇ CEPHE DUVAR KAPLAMASI</b>	LADİN LAMBRI 16 mm + KİSMİ DEKORATİF LAMBRI
<b>İÇ CEPHE ZEMİN</b>	SANDVIÇ PANEL 45 mm + LAMİNANT
<b>İÇ CEPHE TAVAN</b>	LADİN LAMBRI 16 mm
<b>BANYO DUVAR</b>	BOARDEX + CTP DECOPAN
<b>BANYO ZEMİN</b>	BOARDEX + CTP DECOPAN
<b>BANYO TAVAN</b>	BOARDEX + CTP DECOPAN
<b>ELEKTRİK TESİSATI</b>	3x2.5/3x1.5/3x6 YANMAZ BORU HATLI HALDJENFREE KABLO
<b>MUTFAK VE BANYO DOLAPLARI</b>	MDFLAM
<b>MUTFAK VE BANYO TEZGAHI</b>	ÇAM MASIF PANEL 20 mm + TİCK YAĞI
<b>MERDİVEN ALTI DOLAPLARI</b>	-
<b>MERDİVEN BASAMAKLARI</b>	TIRMANMA TİPİ MERDİVEN
<b>İÇ AYDINLATMA</b>	SPOT
<b>DIŞ AYDINLATMA</b>	DUVAR TİPİ APLİK
<b>DOĞRAMA</b>	PVC ANTRASİT
<b>CAM</b>	4+16+4 ISICAM
<b>İÇ KAPI</b>	MDF PANEL KAPI
<b>AKILLI EV TEKNOLOJİSİ</b>	OPSIYONEL
<b>SOLAR ENERJİ SİSTEMİ</b>	OPSIYONEL
<b>ELEKTRİKLİ YERDEN ISITMA</b>	OPSIYONEL
<b>VERANDA</b>	-
<b>İÇ DONATI</b>	BUZDOLABI + MİNİ FIRIN + MİNİ ÇAMAŞIR MAKİNESİ + MİNİ BULAŞIK MAKİNESİ + İKİLİ OCAK + BOİLER + TV + KLİMA + KOLTUK + YATAK

# BERLIN MODEL



## BERLIN TEK LOFT / 8 m

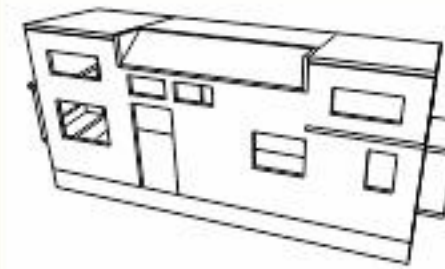
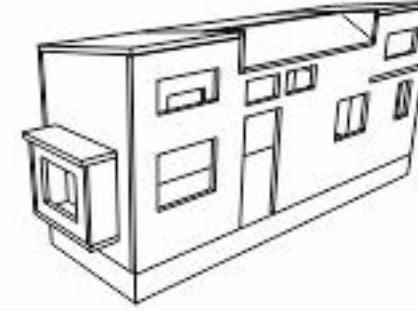

ZEMİN KAT PLANI

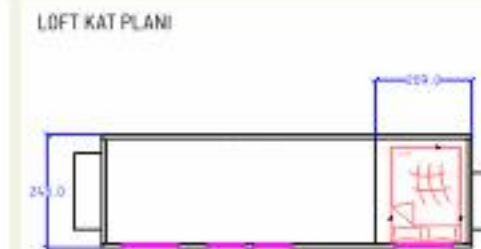

LOFT KAT PLANI

<b>NET KULLANIM ALANI</b>	24,0 m <sup>2</sup>
<b>SINIFI</b>	02 TİPİ ONAY BELGELİ
<b>ŞASI</b>	3-5 mm DALDIRMA GALVANİZ S420 MC ÇELİK
<b>DİNGİL</b>	ÇİFT FRENLİ TORSİYONLU
<b>KAPLIN</b>	KNOOT MARKA
<b>KARKAS</b>	0,8mm kalınlıkta 90x45 mm EBATINDA HAFİF ÇELİK
<b>ÇATI KAPLAMASI</b>	0,5 mm SINÜS METAL
<b>YALITIM</b>	50 dns MİNERAL TAŞYÜNÜ / 8 cm
<b>NEM BARIYERİ</b>	TYVEK
<b>DIŞ CEPHE AHŞAP KAPLAMASI</b>	BOYALI LADİN LAMBRI 16 mm
<b>DIŞ CEPHE METAL KAPLAMASI</b>	0,5 mm KENET METAL
<b>DIŞ CEPHE DİĞER KAPLAMASI</b>	-
<b>İÇ CEPHE DUVAR KAPLAMASI</b>	DUVAR KAĞIDI + KİŞMİ LADİN LAMBRI 16 mm
<b>İÇ CEPHE ZEMİN</b>	SANDVIÇ PANEL 45 mm + LAMİNANT + YERDEN ISITMA
<b>İÇ CEPHE TAVAN</b>	LADİN LAMBRI 16 mm
<b>BANYO DUVAR</b>	BOARDEX + CTP DECOPAN
<b>BANYO ZEMİN</b>	BOARDEX + CTP DECOPAN
<b>BANYO TAVAN</b>	BOARDEX + CTP DECOPAN
<b>ELEKTRİK TESİSATI</b>	3x2,5/3x1,5/3x6 YANMAZ BORU HATLI HALOJENFREE KABLO
<b>MUTFAK VE BANYO DOLAPLARI</b>	MDFLAM
<b>MUTFAK VE BANYO TEZGAHI</b>	ÇAM MASİF PANEL 20 mm + TİCK YAĞI
<b>MERDİVEN ALTI DOLAPLARI</b>	-
<b>MERDİVEN BASAMAKLARI</b>	TIRMANMA TİPİ SÖRGÜLÜ MERDİVEN
<b>İÇ AYDINLATMA</b>	SPOT / RAY SPOT
<b>DIŞ AYDINLATMA</b>	DUVAR TİPİ APLİK
<b>DOĞRAMA</b>	PVC ANTRASİT / AHŞAP GİRİŞ KAPISI
<b>ÇAM</b>	4+1B+4 ISICAM
<b>İÇ KAPI</b>	MDF PANEL KAPI
<b>AKILLI EV TEKNOLOJİSİ</b>	OPSİYONEL
<b>SOLAR ENERJİ SİSTEMİ</b>	OPSİYONEL
<b>ELEKTRİKLİ YERDEN ISITMA</b>	MEVCUT
<b>VERANDA</b>	-
<b>İÇ DONATI</b>	MINİ BUZDOLABI + MINİ ÇAMAŞIR MAKİNESİ + MINİ BULAŞIK MAKİNESİ + MINİ FIRIN + İKİLİ OCAK + KLİMA BOİLER + TV + KOLTUK + YATAK + DUVAR TİPİ YATAK

# OSLO MODEL



## OSLO TEK LOFT / 9 m

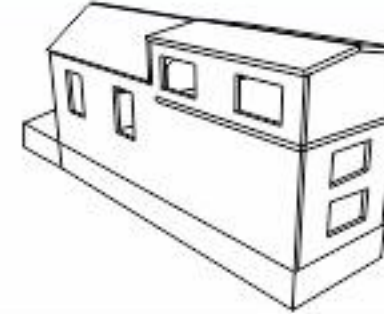

ZEMİN KAT PLANI

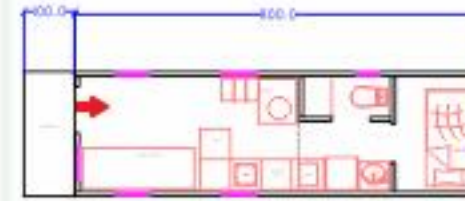

LOFT KAT PLANI



<b>NET KULLANIM ALANI</b>	26,5 m <sup>2</sup>
<b>SINIFI</b>	02 TİPİ ONAY BELGELİ
<b>ŞAŞI</b>	3-5 mm DALDIRMA GALVANİZ S420 MC ÇELİK
<b>DİNGİL</b>	ÇİFT FRENLİ TORSİYONLU
<b>KAPLIN</b>	KNODT MARKA
<b>KARKAS</b>	0,8mm kalınlıkta 90x45 mm EBATINDA HAFIF ÇELİK
<b>ÇATI KAPLAMASI</b>	0,5 mm SINÜS METAL
<b>YALITIM</b>	50 dns MİNERAL TAŞYÜNÜ / 8 cm
<b>NEM BARIYERİ</b>	TYVEK
<b>DIŞ CEPHE AHŞAP KAPLAMASI</b>	BOYALI LADİN LAMBRI 16 mm
<b>DIŞ CEPHE METAL KAPLAMASI</b>	-
<b>DIŞ CEPHE DİĞER KAPLAMASI</b>	BEYAZ KOMPOZİT
<b>İÇ CEPHE DUVAR KAPLAMASI</b>	LADİN LAMBRI 16 mm + KİSİMİ DEKDRATİF LAMBRI
<b>İÇ CEPHE ZEMİN</b>	SANDVIÇ PANEL 45 mm + LAMİNANT
<b>İÇ CEPHE TAVAN</b>	LADİN LAMBRI 16 mm
<b>BANYO DUVAR</b>	BOARDEX + CTP DECOPAN
<b>BANYO ZEMİN</b>	BOARDEX + CTP DECOPAN
<b>BANYO TAVAN</b>	BOARDEX + CTP DECOPAN
<b>ELEKTRİK TESİSATI</b>	3x2,5/3x1,5/3x6 YANMAZ BORU HATLI HALOJENFREE KABLO
<b>MUTFAK VE BANYO DOLAPLARI</b>	MDFLAM
<b>MUTFAK VE BANYO TEZGAHI</b>	ÇAM MASİF PANEL 20 mm + TICK YAĞI
<b>MERDİVEN ALTI DOLAPLARI</b>	MDFLAM
<b>MERDİVEN BASAMAKLARI</b>	ÇAM MASİF PANEL 20 mm + TICK YAĞI / TIRMANMA TİPİ MERDİVEN
<b>İÇ AYDINLATMA</b>	SPOT
<b>DIŞ AYDINLATMA</b>	DUVAR TİPİ APLİK
<b>DOĞRAMA</b>	PVC BEYAZ
<b>CAM</b>	4+16+4 ISICAM
<b>İÇ KAPI</b>	MDF PANEL KAPI
<b>AKILLI EV TEKNOLOJİSİ</b>	OPSİYONEL
<b>SOLAR ENERJİ SİSTEMİ</b>	OPSİYONEL
<b>ELEKTRİKLİ YERDEN ISITMA</b>	OPSİYONEL
<b>VERANDA</b>	AHŞAP DECK KAPLAMA
<b>İÇ DONATI</b>	BUZDOLABI + MİNİ FIRIN + MİNİ BULAŞIK MAKİNESİ İKİLİ OCAK + BÖLER + TV + KLİMA + KOLTUK + YATAK

# LIZBON MODEL



## LIZBON 8 m

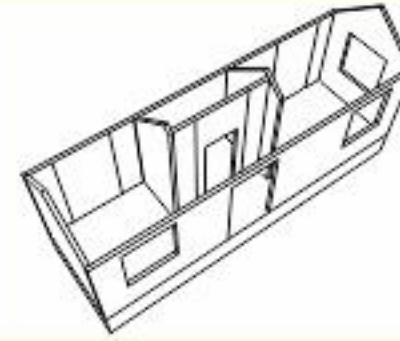
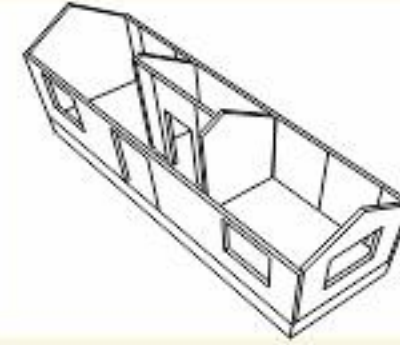

ZEMİN KAT PLANI

<b>NET KULLANIM ALANI</b>	17,8 m <sup>2</sup>
<b>SINIFI</b>	O2 TİPİ ONAY BELGELİ
<b>ŞAŞI</b>	3-5 mm DALDIRMA GALVANİZ S420 MC ÇELİK
<b>DİNGİL</b>	ÇİFT FRENLİ TORSİYONLU
<b>KAPLIN</b>	KNODT MARKA
<b>KARKAS</b>	0,8mm kalınlıkta 90x45 mm EBATINDA HAFİF ÇELİK
<b>ÇATI KAPLAMASI</b>	0,5 mm SINÜS METAL
<b>YALITIM</b>	50 dns MİNERAL TAŞYÜNÜ / 8 cm
<b>NEM BARIYERİ</b>	TYVEK
<b>DIŞ CEPHE AHŞAP KAPLAMASI</b>	BOYALI LADİN LAMBRI 16 mm
<b>DIŞ CEPHE METAL KAPLAMASI</b>	-
<b>DIŞ CEPHE DİĞER KAPLAMASI</b>	-
<b>İÇ CEPHE DUVAR KAPLAMASI</b>	KONTRAPLAK + KİŞİ DUVAR KAĞIDI
<b>İÇ CEPHE ZEMİN</b>	SANDVIÇ PANEL 45 mm + LAMİNANT
<b>İÇ CEPHE TAVAN</b>	0,8 mm KONTRAPLAK
<b>BANYO DUVAR</b>	BOARDEX + CTP DECDPAN
<b>BANYO ZEMİN</b>	BOARDEX + CTP DECDPAN
<b>BANYO TAVAN</b>	THERMWOOD
<b>ELEKTRİK TESİSATI</b>	3x2,5/3x1,5/3x6 YANMAZ BORU HATLI HALOJENFREE KABLO
<b>MUTFAK VE BANYO DOLAPLARI</b>	MDFLAM
<b>MUTFAK VE BANYO TEZGAHI</b>	ÇAM MASİF PANEL 20 mm + TİCK YAĞI
<b>MERDİVEN ALTI DOLAPLARI</b>	-
<b>MERDİVEN BASAMAKLARI</b>	-
<b>İÇ AYDINLATMA</b>	SPDT / RAY SPDT
<b>DIŞ AYDINLATMA</b>	DUVAR TİPİ APLİK
<b>DOĞRAMA</b>	PVC ANTRASİT
<b>CAM</b>	4+16+4 ISICAM
<b>İÇ KAPI</b>	AHŞAP ESKİTME BOYALI KAPI
<b>AKILLI EV TEKNOLOJİSİ</b>	OPSİYONEL
<b>SOLAR ENERJİ SİSTEMİ</b>	OPSİYONEL
<b>ELEKTRİKLİ YERDEN ISITMA</b>	OPSİYONEL
<b>VERANDA</b>	-
<b>İÇ DONATI</b>	MİNİ BUZDOLABI + MİNİ FIRIN + MİNİ ÇAMAŞIR MAKİNESİ + MİNİ BULAŞIK MAKİNESİ + İKİLİ OCAK + ŞOFBEN + TV + KLİMA + YATAK + KOLTUK



# LAS VEGAS<sub>MODEL</sub>



## LAS VEGAS 7 m

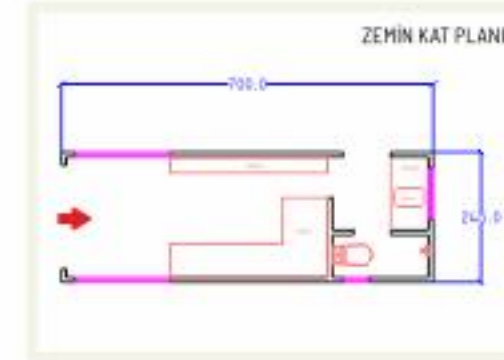
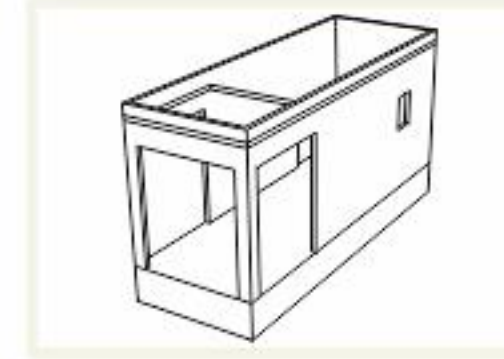
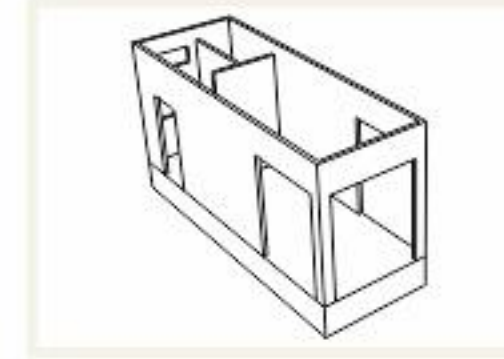

<b>NET KULLANIM ALANI</b>	16,5 m <sup>2</sup>
<b>SINIFI</b>	02 TİPİ ONAY BELGELİ
<b>ŞAŞI</b>	3-5 mm DALDIRMA GALVANİZ S420 MC ÇELİK
<b>DİNGİL</b>	ÇİFT FRENLİ TORSİYONLU
<b>KAPLIN</b>	KNODT MARKA
<b>KARKAS</b>	0,8mm kalınlıkta 90x45 mm EBATINDA HAFİF ÇELİK
<b>ÇATI KAPLAMASI</b>	0,5 mm KENET METAL
<b>YALITIM</b>	50 dns MİNERAL TAŞYÜNÜ / 8 cm
<b>NEM BARIYERİ</b>	TYVEK
<b>DIŞ CEPHE AHŞAP KAPLAMASI</b>	-
<b>DIŞ CEPHE METAL KAPLAMASI</b>	-
<b>DIŞ CEPHE DİĞER KAPLAMASI</b>	REFLEKTE ASAŞ MARKA KOMPOZİT
<b>İÇ CEPHE DUVAR KAPLAMASI</b>	COTTONWALL TEKNOLOJİSİ
<b>İÇ CEPHE ZEMİN</b>	SANDVIÇ PANEL 45 mm + LAMİNANT
<b>İÇ CEPHE TAVAN</b>	DUVAR KAĞIDI
<b>BANYO DUVAR</b>	BOARDEX + CTP DECOPAN
<b>BANYO ZEMİN</b>	BOARDEX + CTP DECOPAN
<b>BANYO TAVAN</b>	BOARDEX + CTP DECOPAN
<b>ELEKTRİK TESİSATI</b>	3x2,5/3x1,5/3x6 YANMAZ BORU HATLI HALOJENFREE KABLO
<b>MUTFAK VE BANYO DOLAPLARI</b>	MDFLAM
<b>MUTFAK VE BANYO TEZGAHI</b>	GRANİT
<b>MERDİVEN ALTI DOLAPLARI</b>	-
<b>MERDİVEN BASAMAKLARI</b>	-
<b>İÇ AYDINLATMA</b>	SPOT / BARISDL GERGİ TAVAN LED
<b>DIŞ AYDINLATMA</b>	-
<b>DOĞRAMA</b>	PVC ANTRASİT
<b>CAM</b>	4+16+4 İSICAM
<b>İÇ KAPI</b>	MDF PANEL KAPI
<b>AKILLI EV TEKNOLOJİSİ</b>	MEVCUT
<b>SOLAR ENERJİ SİSTEMİ</b>	MEVCUT (3 kW)
<b>ELEKTRİKLİ YERDEN ISITMA</b>	OPSİYONEL
<b>VERANDA</b>	-
<b>İÇ DONATI</b>	MINİ BUZDOLABI + İKİLİ OCAK + BÖİLER + TV + KLİMA + ELEKTRİKLİ ŞÖMİNE + SMART PANEL + KOLTUK + YATAK

# KOSOVA 7 METRE MODEL



## KOSOVA TEK LOFT / 7 m

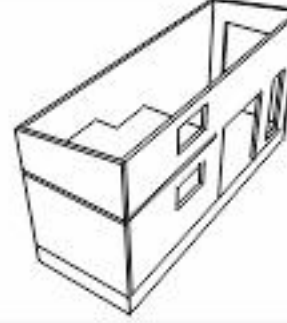
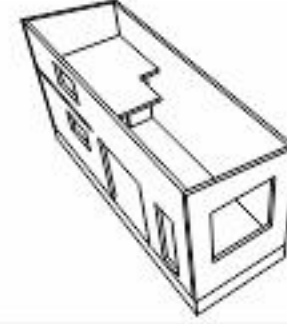

ZEMİN KAT PLANI

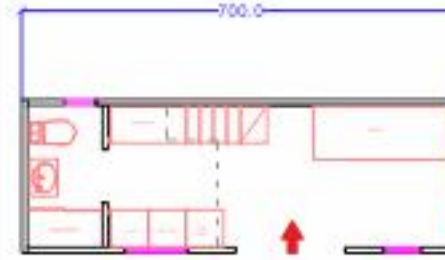

LOFT KAT PLANI



<b>NET KULLANIM ALANI</b>	21,8 m <sup>2</sup>
<b>SINIFI</b>	02 TİPİ ONAY BELGELİ
<b>ŞASI</b>	3-5 mm DALDIRMA GALVANİZ S420 MC ÇELİK
<b>DİNGİL</b>	ÇİFT FRENLİ TORSİYONLU
<b>KAPLİN</b>	KNDOT MARKA
<b>KARKAS</b>	0,8mm kalınlıkta 90x45 mm EBATINDA HAFIF ÇELİK
<b>ÇATI KAPLAMASI</b>	0,5 mm SINÜS METAL
<b>YALITIM</b>	50 dns MİNERAL TAŞYONU / 8 cm
<b>NEM BARIYERİ</b>	TYVEK
<b>DIŞ CEPHE AHŞAP KAPLAMASI</b>	KUZEY ÇAMI THERMDWOOD
<b>DIŞ CEPHE METAL KAPLAMASI</b>	0,5 mm SINÜS METAL
<b>DIŞ CEPHE DİĞER KAPLAMASI</b>	-
<b>İÇ CEPHE DUVAR KAPLAMASI</b>	LADİN LAMBRE 16 mm + KİSMİ DEKORATİF LAMBRE
<b>İÇ CEPHE ZEMİN</b>	SANDVIÇ PANEL 45 mm + LAMİNANT
<b>İÇ CEPHE TAVAN</b>	LADİN LAMBRE 16 mm
<b>BANYO DUVAR</b>	BOARDEX + CTP DECOPAN
<b>BANYO ZEMİN</b>	BOARDEX + CTP DECOPAN
<b>BANYO TAVAN</b>	BOARDEX + CTP DECOPAN
<b>ELEKTRİK TESİSATI</b>	3x2.5/3x1.5/3x6 YANMAZ BORU HATLI HALOJENFREE KABLO
<b>MUTFAK VE BANYO DOLAPLARI</b>	MDFLAM
<b>MUTFAK VE BANYO TEZGAHI</b>	ÇAM MASİF PANEL 20 mm+ TİCK YAĞI
<b>MERDİVEN ALTI DOLAPLARI</b>	MDFLAM
<b>MERDİVEN BASAMAKLARI</b>	ÇAM MASİF PANEL 20 mm+ TİCK YAĞI
<b>İÇ AYDINLATMA</b>	SPDT
<b>DIŞ AYDINLATMA</b>	DUVAR TİPİ APLİK
<b>DOĞRAMA</b>	PVC ANTRASİT
<b>CAM</b>	4+16+4 ISICAM
<b>İÇ KAPI</b>	MDF PANEL KAPI
<b>AKILLI EV TEKNOLOJİSİ</b>	OPSİYONEL
<b>SOLAR ENERJİ SİSTEMİ</b>	OPSİYONEL
<b>ELEKTRİKLİ YERDEN ISITMA</b>	OPSİYONEL
<b>VERANDA</b>	-
<b>İÇ DONATI</b>	FİRİN + MİNİ BUZDOLABI + İKİLİ OCAK + BOİLER + TV + KLİMA + YATAK + KOLTUK

# KOSOVA 8 METRE MODEL



## KOSOVA ÇİFT LOFT / 8 m

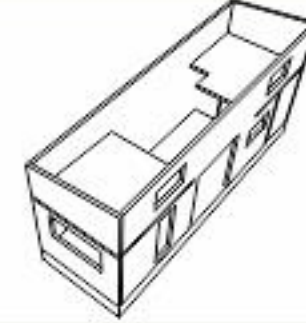
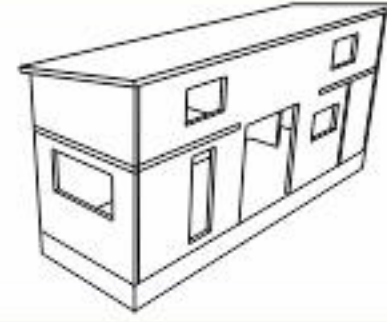

ZEMİN KAT PLANI

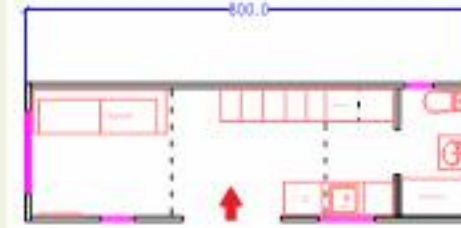

LOFT KAT PLANI



<b>NET KULLANIM ALANI</b>	29,5 m <sup>2</sup>
<b>SINIFI</b>	O2 TİPİ ONAY BELGELİ
<b>ŞAŞI</b>	3-5 mm DALDIRMA GALVANİZ S420 MC ÇELİK
<b>DİNGİL</b>	ÇİFT FRENLİ TORSİYONLU
<b>KAPLİN</b>	KNDOT MARKA
<b>KARKAS</b>	0,8mm kalınlıkta 90x45 mm EBATINDA HAFIF ÇELİK
<b>ÇATI KAPLAMASI</b>	0,5 mm SINÜS METAL
<b>YALITIM</b>	50 dns MİNERAL TAŞYÖNÜ / 8 cm
<b>NEM BARIYERİ</b>	TYVEK
<b>DIŞ CEPHE AHŞAP KAPLAMASI</b>	KUZEY ÇAMI THERMWOOD
<b>DIŞ CEPHE METAL KAPLAMASI</b>	0,5 mm SINÜS METAL
<b>DIŞ CEPHE DİĞER KAPLAMASI</b>	-
<b>İÇ CEPHE DUVAR KAPLAMASI</b>	LADİN LAMBİRİ 16 mm + KİSMİ DEKORATİF LAMBİRİ
<b>İÇ CEPHE ZEMİN</b>	SANDVIÇ PANEL 45 mm + LAMİNANT
<b>İÇ CEPHE TAVAN</b>	LADİN LAMBİRİ 16 mm
<b>BANYO DUVAR</b>	BOARDEX + CTP DECOPAN
<b>BANYO ZEMİN</b>	BOARDEX + CTP DECOPAN
<b>BANYO TAVAN</b>	BOARDEX + CTP DECOPAN
<b>ELEKTRİK TESİSATI</b>	3x2.5/3x1.5/3x6 YANMAZ BORU HATLI HALOJENFREE KABLO
<b>MUTFAK VE BANYO DOLAPLARI</b>	MDFLAM
<b>MUTFAK VE BANYO TEZGAHI</b>	ÇAM MASİF PANEL 20 mm + TICK YAĞI
<b>MERDİVEN ALTI DOLAPLARI</b>	MDFLAM
<b>MERDİVEN BASAMAKLARI</b>	ÇAM MASİF PANEL 20 mm + TICK YAĞI
<b>İÇ AYDINLATMA</b>	SPDT
<b>DIŞ AYDINLATMA</b>	DUVAR TİPİ APLİK
<b>DOĞRAMA</b>	PVC ANTRASİT
<b>CAM</b>	4+16+4 ISICAM
<b>İÇ KAPI</b>	MDF PANEL KAPI
<b>AKILLI EV TEKNOLOJİSİ</b>	OPSİYONEL
<b>SOLAR ENERJİ SİSTEMİ</b>	OPSİYONEL
<b>ELEKTRİKLİ YERDEN ISITMA</b>	OPSİYONEL
<b>VERANDA</b>	-
<b>İÇ DONATI</b>	FİRİN + MİNİ BUZDOLABI + İKİLİ OCAK + BÖİLER + TV + KLİMA + YATAK + KOLTUK

# TURUNCU VAGON MODEL



## TURUNCU VAGON TEK LOFT / 8 m

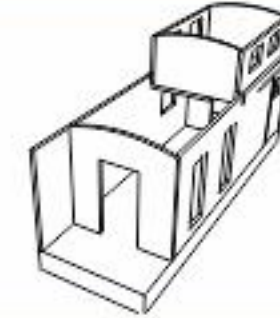
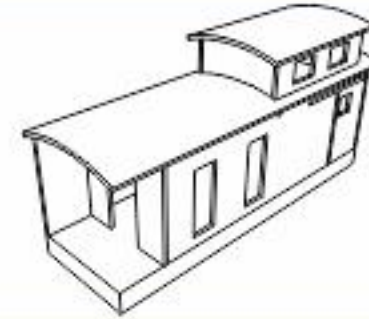

ZEMİN KAT PLANI

LOFT KAT PLANI



<b>NET KULLANIM ALANI</b>	24,5 m <sup>2</sup>
<b>SINIFI</b>	Q2 TİPİ ONAY BELGELİ
<b>ŞAŞI</b>	3-5 mm DALDIRMA GALVANİZ S420 MC ÇELİK
<b>DİNGİL</b>	ÇİFT FRENLİ TORSİYONLU
<b>KAPLIN</b>	KNOOT MARKA
<b>KARKAS</b>	0,8mm kalınlıkta 90x45 mm EBATINDA HAFİF ÇELİK
<b>ÇATI KAPLAMASI</b>	0,5 mm SINÜS METAL
<b>YALITIM</b>	50 dns MİNERAL TAŞYÜNÜ / 8 cm
<b>NEM BARIYERİ</b>	TYVEK
<b>DIŞ CEPHE AHŞAP KAPLAMASI</b>	KUZEY ÇAMI THERMWOOD
<b>DIŞ CEPHE METAL KAPLAMASI</b>	0,5 mm SINÜS METAL
<b>DIŞ CEPHE DİĞER KAPLAMASI</b>	-
<b>İÇ CEPHE DUVAR KAPLAMASI</b>	DUVAR KAĞIDI + KİSMİ LADİN LAMBRI 16 mm + KİSMİ DEKORATİF LAMBRI
<b>İÇ CEPHE ZEMİN</b>	SANDVIÇ PANEL 45 mm + LAMİNANT
<b>İÇ CEPHE TAVAN</b>	LADİN LAMBRI 16 mm
<b>BANYO DUVAR</b>	BOARDEX + CTP DECOPAN + THERMWOOD
<b>BANYO ZEMİN</b>	BOARDEX + CTP DECOPAN
<b>BANYO TAVAN</b>	THERMWOOD
<b>ELEKTRİK TESİSATI</b>	3x2,5/3x1,5/3x6 YANMAZ BORU HATLI HALOJENFREE KABLO
<b>MUTFAK VE BANYO DOLAPLARI</b>	MDFLAM
<b>MUTFAK VE BANYO TEZGAHI</b>	ÇAM MASIF PANEL 20 mm + TICK YAĞI
<b>MERDİVEN ALTI DOLAPLARI</b>	-
<b>MERDİVEN BASAMAKLARI</b>	TIRMANMA TİPİ MERDİVEN
<b>İÇ AYDINLATMA</b>	SPDT / AVİZE
<b>DIŞ AYDINLATMA</b>	DUVAR TİPİ APLİK
<b>DOĞRAMA</b>	PVC ANTRASİT
<b>CAM</b>	4+16+4 ISICAM
<b>İÇ KAPI</b>	MDF PANEL KAPI
<b>AKILLI EV TEKNOLOJİSİ</b>	OPSİYONEL
<b>SOLAR ENERJİ SİSTEMİ</b>	OPSİYONEL
<b>ELEKTRİKLİ YERDEN ISITMA</b>	OPSİYONEL
<b>VERANDA</b>	AHŞAP DECK KAPLAMA
<b>İÇ DONATI</b>	MİKRODALGA + MİNİ BUZDOLABI + İKİLİ OCAK + BOİLER + TV + KLİMA + KOLTUK + YATAK

# KIRMIZI VAGON MODEL



## KIRMIZI VAGON TEK LOFT / 8 m

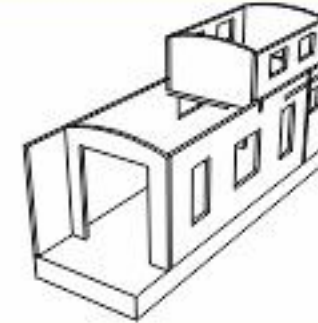
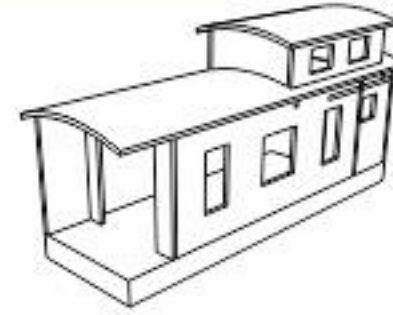

ZEMİN KAT PLANI



LOFT KAT PLANI

<b>NET KULLANIM ALANI</b>	24,5 m <sup>2</sup>
<b>SINIFI</b>	O2 TİPİ ONAY BELGELİ
<b>ŞAŞI</b>	3-5 mm DALDIRMA GALVANİZ S420 MC ÇELİK
<b>DİNGİL</b>	ÇİFT FRENLI TORSİYONLU
<b>KAPLİN</b>	KNODT MARKA
<b>KARKAS</b>	0,8mm kalınlıkta 90x45 mm EBATINDA HAFIF ÇELİK
<b>ÇATI KAPLAMASI</b>	0,5 mm SINÜS METAL
<b>YALITIM</b>	50 dns MİNERAL TAŞYÜNÜ / 8 cm
<b>NEM BARIYERİ</b>	TYVEK
<b>DIŞ CEPHE AHŞAP KAPLAMASI</b>	KUZEY ÇAMI THERMOWOOD
<b>DIŞ CEPHE METAL KAPLAMASI</b>	0,5 mm SINÜS METAL
<b>DIŞ CEPHE DİĞER KAPLAMASI</b>	-
<b>İÇ CEPHE DUVAR KAPLAMASI</b>	KONTRAPLAK + KİSMİ DEKORATİF LAMBRI
<b>İÇ CEPHE ZEMİN</b>	SANDVIÇ PANEL 45 mm + LAMİNANT
<b>İÇ CEPHE TAVAN</b>	LADİN LAMBRI 16 mm
<b>BANYO DUVAR</b>	BOARDEX + CTP DECOPAN + THERMOWOOD
<b>BANYO ZEMİN</b>	BOARDEX + CTP DECOPAN
<b>BANYO TAVAN</b>	BOARDEX + CTP DECOPAN
<b>ELEKTRİK TESİSATI</b>	3x2.5/3x1.5/3x6 YANMAZ BORU HATLI HALOJENFREE KABLO
<b>MUTFAK VE BANYO DOLAPLARI</b>	MDFLAM + AHŞAP
<b>MUTFAK VE BANYO TEZGAHI</b>	ÇAM MASIF PANEL 20 mm + TİCK YAĞI
<b>MERDİVEN ALTI DOLAPLARI</b>	-
<b>MERDİVEN BASAMAKLARI</b>	TIRMANMA TİPİ MERDİVEN
<b>İÇ AYDINLATMA</b>	SPDT / AVİZE
<b>DIŞ AYDINLATMA</b>	DUVAR TİPİ APLİK
<b>DOĞRAMA</b>	PVC ANTRASİT
<b>CAM</b>	4+16+4 İSICAM
<b>İÇ KAPI</b>	MDF PANEL KAPI
<b>AKILLI EV TEKNOLOJİSİ</b>	OPSİYONEL
<b>SOLAR ENERJİ SİSTEMİ</b>	OPSİYONEL
<b>ELEKTRİKLİ YERDEN ISITMA</b>	OPSİYONEL
<b>VERANDA</b>	AHŞAP DECK KAPLAMA
<b>İÇ DONATI</b>	İKİLİ OCAK + MİNİ BUZDOLABI + ŞOFBEN + TV + KLİMA + ELEKTRİKLİ ŞÖMİNE + KOLTUK + YATAK

# OTEL VAGON MODEL



## OTEL VAGON TEK LOFT / 8 m

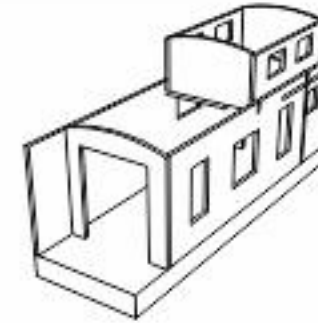
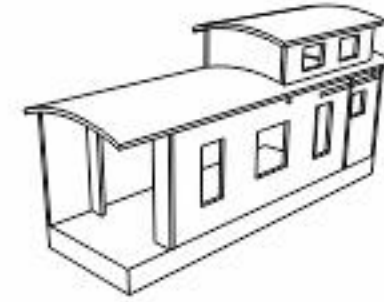

ZEMİN KAT PLANI



LOFT KAT PLANI

<b>NET KULLANIM ALANI</b>	24,5 m <sup>2</sup>
<b>SINIFI</b>	O2 TİPİ ONAY BELGELİ
<b>ŞASI</b>	3-5 mm DALDIRMA GALVANİZ S420 MC ÇELİK
<b>DİNGİL</b>	ÇİFT FRENLİ TORSİYONLU
<b>KAPLIN</b>	KNDOT MARKA
<b>KARKAS</b>	0,8mm kalınlıkta 90x45 mm EBATINDA HAFİF ÇELİK
<b>ÇATI KAPLAMASI</b>	0,5 mm SINÜS METAL
<b>YALITIM</b>	50 dns MİNERAL TAŞYÜNÜ / 8 cm
<b>NEM BARIYERİ</b>	TYVEK
<b>DIŞ CEPHE AHŞAP KAPLAMASI</b>	KUZEY ÇAMI THERMWOOD
<b>DIŞ CEPHE METAL KAPLAMASI</b>	0,5 mm SINÜS METAL
<b>DIŞ CEPHE DİĞER KAPLAMASI</b>	-
<b>İÇ CEPHE DUVAR KAPLAMASI</b>	DUVAR KAĞIDI + KİSMİ DEKORATİF LAMBRE
<b>İÇ CEPHE ZEMİN</b>	SANDVIÇ PANEL 45 mm + LAMİNANT
<b>İÇ CEPHE TAVAN</b>	LADİN LAMBRE 16 mm
<b>BANYO DUVAR</b>	BOARDEX + CTP DECOPAN
<b>BANYO ZEMİN</b>	BOARDEX + CTP DECOPAN
<b>BANYO TAVAN</b>	BOARDEX + CTP DECOPAN
<b>ELEKTRİK TESİSATI</b>	3x2.5/3x1.5/3x6 YANMAZ BORU HATLI HALOJENFREE KABLO
<b>MUTFAK VE BANYO DOLAPLARI</b>	AHŞAP
<b>MUTFAK VE BANYO TEZGAHI</b>	ÇAM MASIF PANEL 20 mm + TİCK YAĞI
<b>MERDİVEN ALTI DOLAPLARI</b>	-
<b>MERDİVEN BASAMAKLARI</b>	TIRMANMA TİPİ MERDİVEN
<b>İÇ AYDINLATMA</b>	SPDT / AVIZE
<b>DIŞ AYDINLATMA</b>	DUVAR TİPİ APLİK
<b>DOĞRAMA</b>	PVC ANTRASİT
<b>CAM</b>	4+16+4 İSICAM
<b>İÇ KAPI</b>	MDF PANEL KAPI
<b>AKILLI EV TEKNOLOJİSİ</b>	OPSİYONEL
<b>SOLAR ENERJİ SİSTEMİ</b>	OPSİYONEL
<b>ELEKTRİKLİ YERDEN ISITMA</b>	OPSİYONEL
<b>VERANDA</b>	AHŞAP DECK KAPLAMA
<b>İÇ DONATI</b>	MINİ BUZDOLABI + ŞOFBEN + TV + KLİMA + KOLTUK + YATAK

# VAGON MODEL



doğa  
ve sen

## VAGON MODEL 8 m

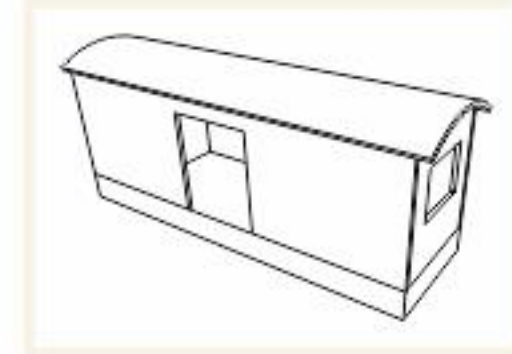
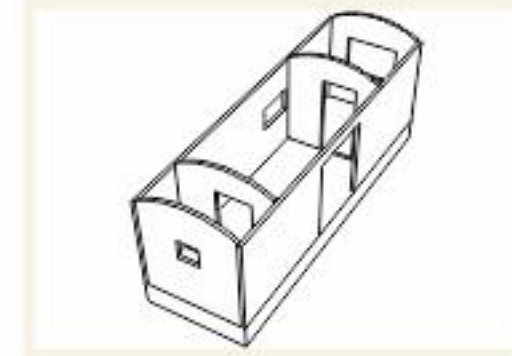

ZEMİN KAT PLANI

<b>NET KULLANIM ALANI</b>	17,8 m <sup>2</sup>
<b>SINIFI</b>	02 TİPİ ONAY BELGELİ
<b>ŞASE</b>	3-5 mm DALDIRMA GALVANİZ S420 MC ÇELİK
<b>DİNGİL</b>	ÇİFT FRENLİ TORSİYONLU
<b>KAPLIN</b>	KNODT MARKA
<b>KARKAS</b>	0,8mm kalınlıkta 90x45 mm EBATINDA HAFİF ÇELİK
<b>ÇATI KAPLAMASI</b>	0,5 mm SINÜS METAL
<b>YALITIM</b>	50 dns MİNERAL TAŞYÜNÜ / 8 cm
<b>NEM BARIYERİ</b>	TYVEK
<b>DIŞ CEPHE AHŞAP KAPLAMASI</b>	KUZEY ÇAMI THERMOWOOD
<b>DIŞ CEPHE METAL KAPLAMASI</b>	0,5 mm SINÜS METAL
<b>DIŞ CEPHE DİĞER KAPLAMASI</b>	-
<b>İÇ CEPHE DUVAR KAPLAMASI</b>	DUVAR KAĞIDI + KİSİMİ DEKORATİF LAMBRI + KONTRAPLAK
<b>İÇ CEPHE ZEMİN</b>	SANDVIÇ PANEL 45 mm + LAMİNANT
<b>İÇ CEPHE TAVAN</b>	KONTRAPLAK
<b>BANYO DUVAR</b>	BOARDEX + CTP DECOPAN
<b>BANYO ZEMİN</b>	BOARDEX + CTP DECOPAN
<b>BANYO TAVAN</b>	BOARDEX + CTP DECOPAN
<b>ELEKTRİK TESİSATI</b>	3x2.5/3x1.5/3x6 YANMAZ BORU HATLI HALOJENFREE KABLO
<b>MUTFAK VE BANYO DOLAPLARI</b>	MDFLAM
<b>MUTFAK VE BANYO TEZGAHI</b>	ÇAM MASIF PANEL 20 mm + TICK YAĞI
<b>MERDİVEN ALTI DOLAPLARI</b>	-
<b>MERDİVEN BASAMAKLARI</b>	-
<b>İÇ AYDINLATMA</b>	SPDT
<b>DIŞ AYDINLATMA</b>	-
<b>DOĞRAMA</b>	PVC ANTRASİT
<b>CAM</b>	4+16+4 İSICAM
<b>İÇ KAPI</b>	MDF PANEL KAPI
<b>AKILLI EV TEKNOLOJİSİ</b>	OPSİYONEL
<b>SOLAR ENERJİ SİSTEMİ</b>	OPSİYONEL
<b>ELEKTRİKLİ YERDEN ISITMA</b>	OPSİYONEL
<b>VERANDA</b>	-
<b>İÇ DONATI</b>	FİRİN + İKİLİ OCAK + MİNİ BUZDOLABI + BÖİLER + DAVLUMBAZ + TV + KLİMA + KOLTUK + YATAK

# BEYAZ İSTANBUL MODEL



## BEYAZ İSTANBUL TEK LOFT / 8 m

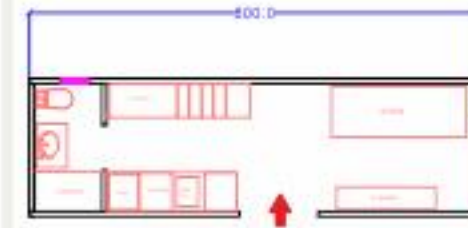
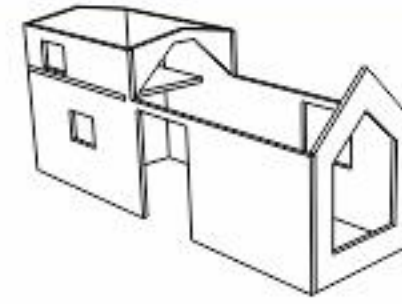

ZEMİN KAT PLANI

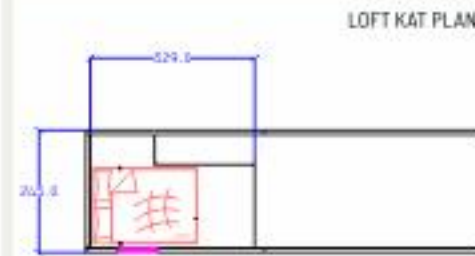

LOFT KAT PLANI



<b>NET KULLANIM ALANI</b>	24,0 m <sup>2</sup>
<b>SINIFI</b>	02 TİPİ ONAY BELGELİ
<b>ŞASI</b>	3-5 mm DALDIRMA GALVANİZ S420 MC ÇELİK
<b>DİNGİL</b>	ÇİFT FRENLİ TORSİYONLU
<b>KAPLIN</b>	KNOOT MARKA
<b>KARKAS</b>	0,8mm kalınlıkta 90x45 mm EBATINDA HAFIF ÇELİK
<b>ÇATI KAPLAMASI</b>	0,5 mm KENET METAL
<b>YALITIM</b>	50 dñs MİNERAL TAŞYÖNÜ / 8 cm
<b>NEM BARIYERİ</b>	TYVEK
<b>DIŞ CEPHE AHŞAP KAPLAMASI</b>	KUZEY ÇAMI THERMOWOOD
<b>DIŞ CEPHE METAL KAPLAMASI</b>	0,5 mm KENET METAL
<b>DIŞ CEPHE DİĞER KAPLAMASI</b>	-
<b>İÇ CEPHE DUVAR KAPLAMASI</b>	DUVAR KAĞIDI + KİSMİ DEKORATİF LAMBRE
<b>İÇ CEPHE ZEMİN</b>	SANDVIÇ PANEL 45 mm + LAMİNANT
<b>İÇ CEPHE TAVAN</b>	LADİN LAMBRE 16 mm
<b>BANYO DUVAR</b>	BOARDEX + CTP DECOPAN + THERMOWOOD
<b>BANYO ZEMİN</b>	BOARDEX + CTP DECOPAN
<b>BANYO TAVAN</b>	BOARDEX + CTP DECOPAN
<b>ELEKTRİK TESİSATI</b>	3x2,5/3x1,5/3x6 YANMAZ BORU HATLI HALOJENFREE KABLO
<b>MUTFAK VE BANYO DOLAPLARI</b>	MDFLAM
<b>MUTFAK VE BANYO TEZGAHI</b>	ÇAM MASIF PANEL 20 mm+ TİCK YAĞI
<b>MERDİVEN ALTI DOLAPLARI</b>	MDFLAM
<b>MERDİVEN BASAMAKLARI</b>	ÇAM MASIF PANEL 20 mm+ TİCK YAĞI
<b>İÇ AYDINLATMA</b>	SPDT
<b>DIŞ AYDINLATMA</b>	DUVAR TİPİ APLİK
<b>DOĞRAMA</b>	PVC ANTRASİT
<b>CAM</b>	4+16+4 ISICAM
<b>İÇ KAPI</b>	MDF PANEL KAPI
<b>AKILLI EV TEKNOLOJİSİ</b>	OPSİYONEL
<b>SOLAR ENERJİ SİSTEMİ</b>	OPSİYONEL
<b>ELEKTRİKLİ YERDEN ISITMA</b>	OPSİYONEL
<b>VERANDA</b>	-
<b>İÇ DONATI</b>	FİRİN + DÖRTLÜ OCAK + TV + KLİMA +DAVLUMBAZ + BOİLER + MİNİ BUZDOLABI + KOLTUK + YATAK



# İSTANBUL MODEL



## İSTANBUL TEK LOFT / 8 m

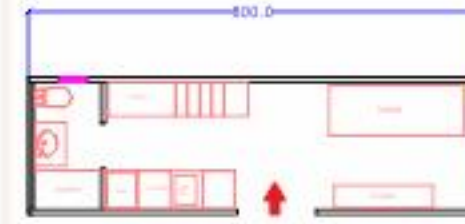
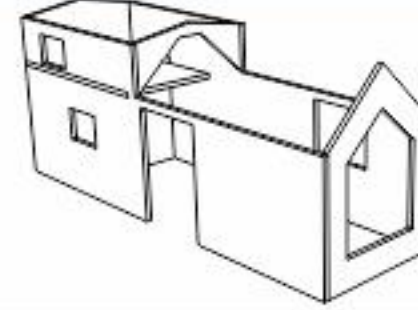

ZEMİN KAT PLANI

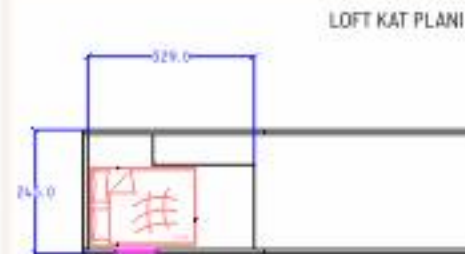

LOFT KAT PLANI

<b>NET KULLANIM ALANI</b>	24,0 m <sup>2</sup>
<b>SINIFI</b>	02 TİPİ ONAY BELGELİ
<b>ŞASI</b>	3-5 mm DALDIRMA GALVANİZ S420 MC ÇELİK
<b>DİNGİL</b>	ÇİFT FRENLİ TORSİYONLU
<b>KAPLİN</b>	KNOOT MARKA
<b>KARKAS</b>	0,8mm kalınlıkta 90x45 mm EBATINDA HAFIF ÇELİK
<b>ÇATI KAPLAMASI</b>	0,5 mm KENET METAL
<b>YALITIM</b>	50 dns MİNERAL TAŞYÖNÜ / 8 cm
<b>NEM BARIYERİ</b>	TYVEK
<b>DIŞ CEPHE AHŞAP KAPLAMASI</b>	KUZEY ÇAMI THERMOWOOD
<b>DIŞ CEPHE METAL KAPLAMASI</b>	0,5 mm KENET METAL
<b>DIŞ CEPHE DİĞER KAPLAMASI</b>	-
<b>İÇ CEPHE DUVAR KAPLAMASI</b>	LADİN LAMBİRİ 16 mm
<b>İÇ CEPHE ZEMİN</b>	SANDVIÇ PANEL 45 mm + LAMİNANT
<b>İÇ CEPHE TAVAN</b>	LADİN LAMBİRİ 16 mm
<b>BANYO DUVAR</b>	BOARDEX + CTP DECOPAN
<b>BANYO ZEMİN</b>	BOARDEX + CTP DECOPAN
<b>BANYO TAVAN</b>	BOARDEX + CTP DECOPAN
<b>ELEKTRİK TESİSATI</b>	3x2.5/3x1.5/3x6 YANMAZ BORU HATLI HALOJENFREE KABLO
<b>MUTFAK VE BANYO DOLAPLARI</b>	MDFLAM
<b>MUTFAK VE BANYO TEZGAHI</b>	ÇAM MASİF PANEL 20 mm+ TİCK YAĞI
<b>MERDİVEN ALTI DOLAPLARI</b>	MDFLAM
<b>MERDİVEN BASAMAKLARI</b>	ÇAM MASİF PANEL 20 mm + TİCK YAĞI
<b>İÇ AYDINLATMA</b>	SPOT
<b>DIŞ AYDINLATMA</b>	DUVAR TİPİ APLİK
<b>DOĞRAMA</b>	PVC ANTRASİT
<b>CAM</b>	4+16+4 ISICAM
<b>İÇ KAPI</b>	MDF PANEL KAPI
<b>AKILLI EV TEKNOLOJİSİ</b>	OPSİYONEL
<b>SOLAR ENERJİ SİSTEMİ</b>	OPSİYONEL
<b>ELEKTRİKLİ YERDEN ISITMA</b>	OPSİYONEL
<b>VERANDA</b>	-
<b>İÇ DONATI</b>	MİKRODALGA + İKİLİ OCAK + TV + KLİMA + BOİLER + MİNİ BUZDOLABI + KOLTUK + YATAK

# İSTANBUL 6 METRE MODEL



## İSTANBUL TEK LOFT / 6 m

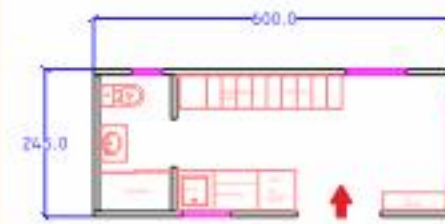
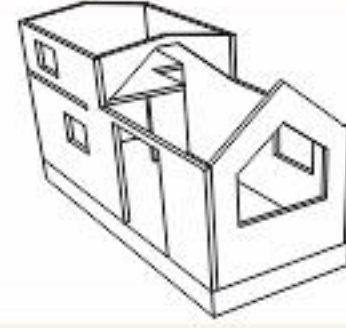

ZEMİN KAT PLANI

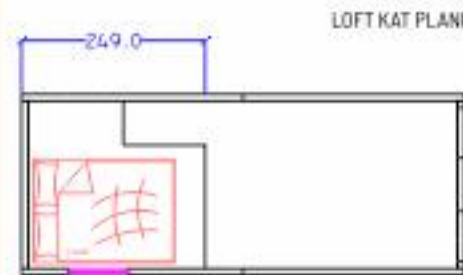

LOFT KAT PLANI

<b>NET KULLANIM ALANI</b>	18,0 m <sup>2</sup>
<b>SINIFI</b>	O2 TİPİ ONAY BELGELİ
<b>ŞASI</b>	3-5 mm DALDIRMA GALVANİZ S420 MC ÇELİK
<b>DİNGİL</b>	ÇİFT FRENLİ TORSİYONLU
<b>KAPLIN</b>	KNODT MARKA
<b>KARKAS</b>	0,8mm kalınlıkta 90x45 mm EBATINDA HAFİF ÇELİK
<b>ÇATI KAPLAMASI</b>	0,5 mm KENET METAL
<b>YALITIM</b>	50 dns MINERAL TAŞYÜNÜ / 8 cm
<b>NEM BARIYERİ</b>	TYVEK
<b>DIŞ CEPHE AHŞAP KAPLAMASI</b>	KUZEY ÇAMI THERMOWOOD
<b>DIŞ CEPHE METAL KAPLAMASI</b>	0,5 mm KENET METAL
<b>DIŞ CEPHE DİĞER KAPLAMASI</b>	-
<b>İÇ CEPHE DUVAR KAPLAMASI</b>	KONTRAPLAK + KISMİ DEKORATİF LAMBRI
<b>İÇ CEPHE ZEMİN</b>	SANDVIÇ PANEL 45 mm + LAMINANT
<b>İÇ CEPHE TAVAN</b>	KONTRAPLAK
<b>BANYO DUVAR</b>	BOARDEX + CTP DECOPAN + THERMOWOOD
<b>BANYO ZEMİN</b>	BOARDEX + CTP DECOPAN
<b>BANYO TAVAN</b>	BOARDEX + CTP DECOPAN
<b>ELEKTRİK TESİSATI</b>	3x2.5/3x1.5/3x6 YANMAZ BORU HATLI HALOJENFREE KABLO
<b>MUTFAK VE BANYO DOLAPLARI</b>	MDFLAM
<b>MUTFAK VE BANYO TEZGAHI</b>	ÇAM MASIF PANEL 20 mm+ TİCK YAĞI
<b>MERDİVEN ALTI DOLAPLARI</b>	MDFLAM
<b>MERDİVEN BASAMAKLARI</b>	ÇAM MASIF PANEL 20 mm + TİCK YAĞI
<b>İÇ AYDINLATMA</b>	SPOT
<b>DIŞ AYDINLATMA</b>	DUVAR TİPİ APLİK
<b>DOĞRAMA</b>	PVC ANTRASİT
<b>CAM</b>	4+16+4 ISICAM
<b>İÇ KAPI</b>	MDF PANEL KAPI
<b>AKILLI EV TEKNOLOJİSİ</b>	OPSİYONEL
<b>SOLAR ENERJİ SİSTEMİ</b>	OPSİYONEL
<b>ELEKTRİKLİ YERDEN ISITMA</b>	OPSİYONEL
<b>VERANDA</b>	-
<b>İÇ DONATI</b>	MİKRODALGA + İKİLİ OCAK + TV + KLİMA + BOİLER + MINİ BUZDOLABI + MINİ BULAŞIK MAKİNESİ + KOLTUK + YATAK

# MILKMODEL



## MILK MODEL TEK LOFT / 5 m

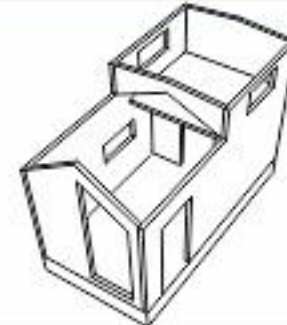

ZEMİN KAT PLANI

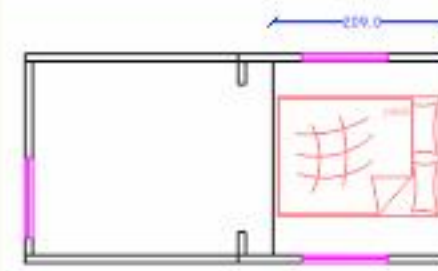

LOFT KAT PLANI

<b>NET KULLANIM ALANI</b>	15,5 m <sup>2</sup>
<b>SINIFI</b>	02 TİPİ ONAY BELGELİ
<b>ŞAŞI</b>	3-5 mm DALDIRMA GALVANİZ S420 MC ÇELİK
<b>DİNGİL</b>	ÇİFT FRENLİ TORSİYONLU
<b>KAPLIN</b>	KNODT MARKA
<b>KARKAS</b>	0,8mm kalınlıkta 90x45 mm EBATINDA HAFIF ÇELİK
<b>ÇATI KAPLAMASI</b>	0,5 mm SINÜS METAL
<b>YALITIM</b>	65 dñs MINERAL TAŞYÜNÜ / 8 cm
<b>NEH BARIYERİ</b>	TYVEK
<b>DIŞ CEPHE AHŞAP KAPLAMASI</b>	-
<b>DIŞ CEPHE METAL KAPLAMASI</b>	0,5 mm KENET METAL
<b>DIŞ CEPHE DİĞER KAPLAMASI</b>	-
<b>İÇ CEPHE DUVAR KAPLAMASI</b>	LADİN LAMBRI 16 mm
<b>İÇ CEPHE ZEMİN</b>	SANDVIÇ PANEL 45 mm + LAMİNANT
<b>İÇ CEPHE TAVAN</b>	LADİN LAMBRI 16 mm
<b>BANYO DUVAR</b>	BOARDEX + CTP DECOPAN
<b>BANYO ZEMİN</b>	BOARDEX + CTP DECOPAN
<b>BANYO TAVAN</b>	BOARDEX + CTP DECOPAN
<b>ELEKTRİK TESİSATI</b>	3x2,5/3x1,5/3x6 YANMAZ BORU HATLI HALOJENFREE KABLO
<b>MUTFAK VE BANYO DOLAPLARI</b>	MDFLAM
<b>MUTFAK VE BANYO TEZGAHI</b>	ÇAM MASİF PANEL 20 mm + TİCK YAĞI
<b>MERDİVEN ALTI DOLAPLARI</b>	-
<b>MERDİVEN BASAMAKLARI</b>	TIRMANMA TİPİ MERDİVEN
<b>İÇ AYDINLATMA</b>	SPDT
<b>DIŞ AYDINLATMA</b>	DUVAR TİPİ APLİK
<b>DOĞRAMA</b>	PVC ANTRASİT
<b>ÇAM</b>	4+16+4 ISICAM
<b>İÇ KAPI</b>	MDF PANEL KAPI
<b>AKILLI EV TEKNOLOJİSİ</b>	OPSİYONEL
<b>SOLAR ENERJİ SİSTEMİ</b>	OPSİYONEL
<b>ELEKTRİKLİ YERDEN ISITMA</b>	OPSİYONEL
<b>VERANDA</b>	-
<b>İÇ DONATI</b>	İKİLİ OCAK + MINİ BUZDOLABI + TV + BOİLER + KLİMA + KOLTUK YATAK

# SAUNA MODEL



## SAUNA 6 m

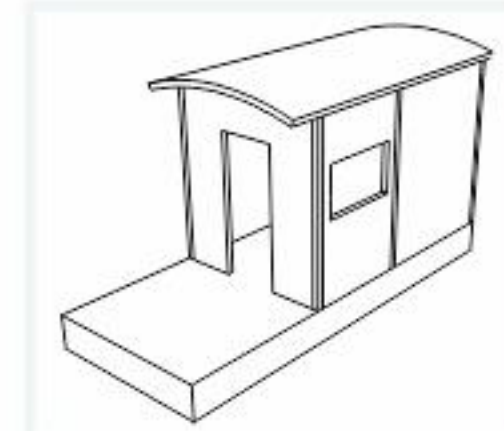

<b>NET KULLANIM ALANI</b>	14,7 m <sup>2</sup>
<b>SINIFI</b>	02 TİPİ ONAY BELGELİ
<b>ŞAŞI</b>	3-5 mm DALDIRMA GALVANİZ S420 MC ÇELİK
<b>DİNGİL</b>	ÇİFT FRENLİ TORSİYONLU
<b>KAPLIN</b>	KNDOT MARKA
<b>KARKAS</b>	0,8mm kalınlıkta 90x45 mm EBATINDA HAFİF ÇELİK
<b>ÇATI KAPLAMASI</b>	0,5 mm SİNÜS METAL
<b>YALITIM</b>	<b>POLİÜRETAN</b>
<b>NEM BARIYERİ</b>	-
<b>DIŞ CEPHE AHŞAP KAPLAMASI</b>	-
<b>DIŞ CEPHE METAL KAPLAMASI</b>	-
<b>DIŞ CEPHE DİĞER KAPLAMASI</b>	-
<b>İÇ CEPHE DUVAR KAPLAMASI</b>	LADİN LAMBRI 16 mm
<b>İÇ CEPHE ZEMİN</b>	SANOVİÇ PANEL + <b>POLİÜRETAN</b> + LADİN RABİTA
<b>İÇ CEPHE TAVAN</b>	LADİN LAMBRI
<b>BANYO DUVAR</b>	-
<b>BANYO ZEMİN</b>	-
<b>BANYO TAVAN</b>	-
<b>ELEKTRİK TESİSATI</b>	3x2,5/3x1,5/3x6 YANMAZ BORU HATLI HALOJENFREE KABLO
<b>MUTFAK VE BANYO DOLAPLARI</b>	-
<b>MUTFAK VE BANYO TEZGAHI</b>	-
<b>MERDİVEN ALTI DOLAPLARI</b>	-
<b>MERDİVEN BASAMAKLARI</b>	-
<b>İÇ AYDINLATMA</b>	SPOT / DUVAR TİPİ APLİK
<b>DIŞ AYDINLATMA</b>	DUVAR TİPİ APLİK
<b>DOĞRAMA</b>	PVC DOĞRAMA
<b>CAM</b>	SATİNE CAM
<b>İÇ KAPI</b>	ALÜMİNYUM DOĞRAMA
<b>AKILLI EV TEKNOLOJİSİ</b>	OPSİYONEL
<b>SOLAR ENERJİ SİSTEMİ</b>	OPSİYONEL
<b>ELEKTRİKLİ YERDEN ISITMA</b>	OPSİYONEL
<b>VERANDA</b>	<b>AHŞAP DECK KAPLAMA</b>
<b>İÇ DONATI</b>	MİNİ BUZDOLABI + SAUNA SOBASI + BENCH

# PEMBE KÖŞK MODEL



## PEMBE KÖŞK TEK LOFT / 8 m

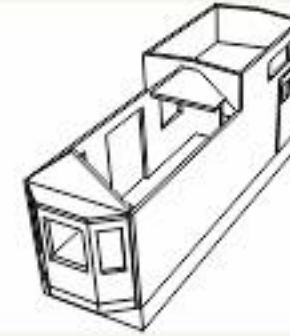

ZEMİN KAT PLANI

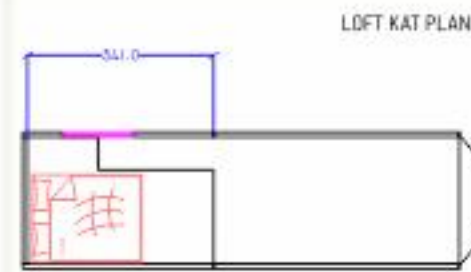

LOFT KAT PLANI

<b>NET KULLANIM ALANI</b>	25,7 m <sup>2</sup>
<b>SINIFI</b>	02 TİPİ ONAY BELGELİ
<b>ŞASI</b>	3-5 mm DALDIRMA GALVANİZ S420 MC ÇELİK
<b>DİNGİL</b>	ÇİFT FRENLİ TORSİYONLU
<b>KAPLIN</b>	KNODT MARKA
<b>KARKAS</b>	0,8mm kalınlıkta 90x45 mm EBATINDA HAFIF ÇELİK
<b>ÇATI KAPLAMASI</b>	0,5 mm KENET METAL
<b>YALITIM</b>	50 dns MİNERAL TAŞYÜNÜ / 8 cm
<b>NEM BARIYERİ</b>	TYVEK
<b>DIŞ CEPHE AHŞAP KAPLAMASI</b>	BOYALI LADİN LAMBRI 16 mm
<b>DIŞ CEPHE METAL KAPLAMASI</b>	0,5 mm KENET METAL
<b>DIŞ CEPHE DİĞER KAPLAMASI</b>	-
<b>İÇ CEPHE DUVAR KAPLAMASI</b>	LADİN LAMBRI 16 mm + KİSMİ DEKORATİF LAMBRI
<b>İÇ CEPHE ZEMİN</b>	SANDVIÇ PANEL 45 mm + LAMİNANT
<b>İÇ CEPHE TAVAN</b>	LADİN LAMBRI 16 mm
<b>BANYO DUVAR</b>	BOARDEX + CTP DECOPAN
<b>BANYO ZEMİN</b>	BOARDEX + CTP DECOPAN
<b>BANYO TAVAN</b>	BOARDEX + CTP DECOPAN
<b>ELEKTRİK TESİSATI</b>	3x2,5/3x1,5/3x6 YANMAZ BORU HATLI HALOJENFREE KABLO
<b>MUTFAK VE BANYO DOLAPLARI</b>	MDFLAM
<b>MUTFAK VE BANYO TEZGAHI</b>	ÇAM MASİF PANEL 20 mm + TICK YAĞI
<b>MERDİVEN ALTI DOLAPLARI</b>	MDFLAM
<b>MERDİVEN BASAMAKLARI</b>	ÇAM MASİF PANEL 20 mm + TICK YAĞI
<b>İÇ AYDINLATMA</b>	SPOT
<b>DIŞ AYDINLATMA</b>	-
<b>DOĞRAMA</b>	PVC ANTRASİT
<b>CAM</b>	4+16+4 İSICAM
<b>İÇ KAPI</b>	MDF PANEL KAPI
<b>AKILLI EV TEKNOLOJİSİ</b>	OPSİYONEL
<b>SOLAR ENERJİ SİSTEMİ</b>	OPSİYONEL
<b>ELEKTRİKLİ YERDEN ISITMA</b>	OPSİYONEL
<b>VERANDA</b>	-
<b>İÇ DONATI</b>	FİRİN + DÖRTLÜ OCAK + MİNİ BUZDOLABI BOİLER + TV + KOLTUK + YATAK

# BRITISH MODEL



## BRITISH ÇİFT LOFT / 8 m

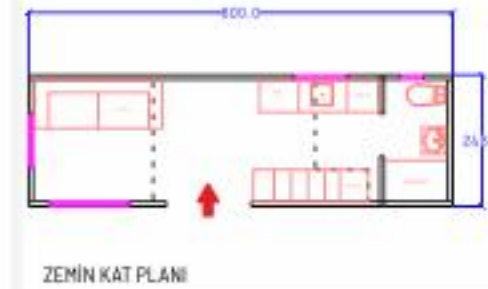
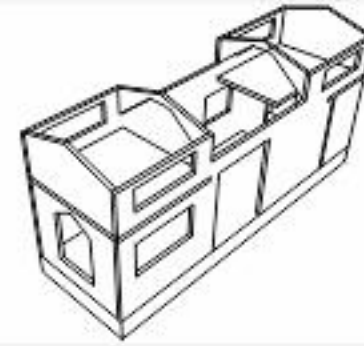

ZEMİN KAT PLANI



LOFT KAT PLANI

<b>NET KULLANIM ALANI</b>	28,5 m <sup>2</sup>
<b>SINIFI</b>	02 TİPİ ONAY BELGELİ
<b>ŞASI</b>	3-5 mm DALDIRMA GALVANİZ S420 MC ÇELİK
<b>DİNGİL</b>	ÇİFT FRENLİ TORSİYONLU
<b>KAPLIN</b>	KNODT MARKA
<b>KARKAS</b>	0,8mm kalınlıkta 90x45 mm EBATINDA HAFİF ÇELİK
<b>ÇATI KAPLAMASI</b>	0,5 mm SINÜS METAL
<b>YALITIM</b>	50 dns MİNERAL TAŞYÖNÜ / 8 cm
<b>NEM BARIYERİ</b>	TYVEK
<b>DIŞ CEPHE AHŞAP KAPLAMASI</b>	KUZEY ÇAMI THEMOWOOD
<b>DIŞ CEPHE METAL KAPLAMASI</b>	0,5 mm SINÜS METAL
<b>DIŞ CEPHE DİĞER KAPLAMASI</b>	-
<b>İÇ CEPHE DUVAR KAPLAMASI</b>	LADİN LAMBRI 16 mm
<b>İÇ CEPHE ZEMİN</b>	SANOVİÇ PANEL 45 mm + LAMİNANT
<b>İÇ CEPHE TAVAN</b>	LADİN LAMBRI 16 mm
<b>BANYO DUVAR</b>	BOARDEX + CTP DECOPAN
<b>BANYO ZEMİN</b>	BOARDEX + CTP DECOPAN
<b>BANYO TAVAN</b>	BOARDEX + CTP DECOPAN
<b>ELEKTRİK TESİSATI</b>	3x2,5/3x1,5/3x6 YANMAZ BDRU HATLI HALDJENFREE KABLO
<b>MUTFAK VE BANYO DOLAPLARI</b>	MDFLAM
<b>MUTFAK VE BANYO TEZGAHI</b>	ÇAM MASİF PANEL 20 mm + TİCK YAĞI
<b>MERDİVEN ALTI DOLAPLARI</b>	MDFLAM
<b>MERDİVEN BASAMAKLARI</b>	ÇAM MASİF PANEL 20 mm + TİCK YAĞI
<b>İÇ AYDINLATMA</b>	SPOT
<b>DIŞ AYDINLATMA</b>	DUVAR TİPİ APLİK
<b>DOĞRAMA</b>	PVC ANTRASİT
<b>ÇAM</b>	4+16+4 İSICAM
<b>İÇ KAPI</b>	MDF PANEL KAPI
<b>AKILLI EV TEKNOLOJİSİ</b>	OPSİYONEL
<b>SOLAR ENERJİ SİSTEMİ</b>	OPSİYONEL
<b>ELEKTRİKLİ YERDEN ISITMA</b>	OPSİYONEL
<b>VERANDA</b>	-
<b>İÇ DONATI</b>	FİRİN + İKİLİ OCAK + DAVLUMBAZ + BOILER + TV + KLİMA + KOLTUK + YATAK

# ALAÇATI MODEL



## ALAÇATI TEK LOFT / 8 m

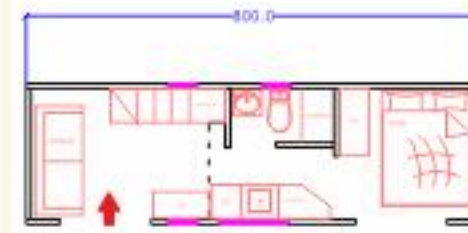
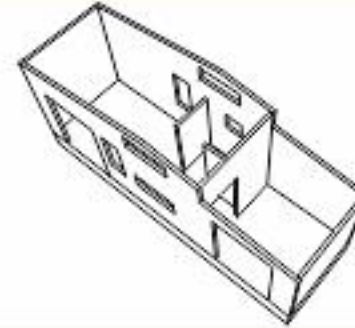
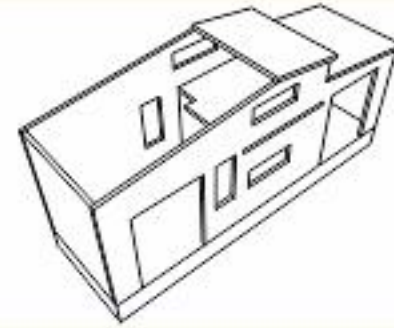

ZEMİN KAT PLANI

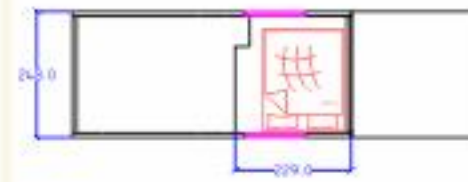

LOFT KAT PLANI

<b>NET KULLANIM ALANI</b>	23,0 m <sup>2</sup>
<b>SINIFI</b>	02 TİPİ ONAY BELGELİ
<b>ŞAŞI</b>	3-5 mm DALDIRMA GALVANİZ S420 MC ÇELİK
<b>DİNGİL</b>	ÇİFT FRENLİ TORSİYONLU
<b>KAPLIN</b>	KNOOT MARKA
<b>KARKAS</b>	0,8mm kalınlıkta 90x45 mm EBATINDA HAFİF ÇELİK
<b>ÇATI KAPLAMASI</b>	0,5 mm KENET METAL
<b>YALITIM</b>	50 dñs MINERAL TAŞYÜNÜ / 8 cm
<b>NEH BARIYERİ</b>	TYVEK
<b>DIŞ CEPHE AHŞAP KAPLAMASI</b>	KUZEY ÇAMI THERMOWOOD
<b>DIŞ CEPHE METAL KAPLAMASI</b>	0,5 mm KENET METAL
<b>DIŞ CEPHE DİĞER KAPLAMASI</b>	-
<b>İÇ CEPHE DUVAR KAPLAMASI</b>	DUVAR KAĞIDI + KESİMİ DEKORATİF LAMBRI
<b>İÇ CEPHE ZEMİN</b>	SANDVIÇ PANEL 45 mm + LAMİNANT
<b>İÇ CEPHE TAVAN</b>	LADİN LAMBRI 16 mm
<b>BANYO DUVAR</b>	BOARDEX + CTP DECOPAN
<b>BANYO ZEMİN</b>	BOARDEX + CTP DECOPAN
<b>BANYO TAVAN</b>	BOARDEX + CTP DECOPAN
<b>ELEKTRİK TESİSATI</b>	3x2,5/3x1,5/3x6 YANMAZ BORU HATLI HALOJENFREE KABLO
<b>MUTFAK VE BANYO DOLAPLARI</b>	MDFLAM
<b>MUTFAK VE BANYO TEZGAHI</b>	ÇAM MASİF PANEL 20 mm + TICK YAĞI
<b>MERDİVEN ALTI DOLAPLARI</b>	MDFLAM
<b>MERDİVEN BASAMAKLARI</b>	ÇAM MASİF PANEL 20 mm + TICK YAĞI
<b>İÇ AYDINLATMA</b>	SPOT
<b>DIŞ AYDINLATMA</b>	DUVAR TİPİ APLİK
<b>DOĞRAMA</b>	PVC ANTRASİT
<b>ÇAM</b>	4+16+4 ISICAM
<b>İÇ KAPI</b>	MDF PANEL KAPI
<b>AKILLI EV TEKNOLOJİSİ</b>	OPSİYONEL
<b>SOLAR ENERJİ SİSTEMİ</b>	OPSİYONEL
<b>ELEKTRİK YERDEN ISITMA</b>	OPSİYONEL
<b>VERANDA</b>	-
<b>İÇ DONATI</b>	MİNİ FIRIN + İKİLİ DCAK + DAVLUMBAZ + TV + KLİMA + MİNİ BUZDOLABI + KOLTUK + YATAK

# L TİPİ OTEL MODEL



## L TİPİ OTEL MODEL 9 m - 4 m

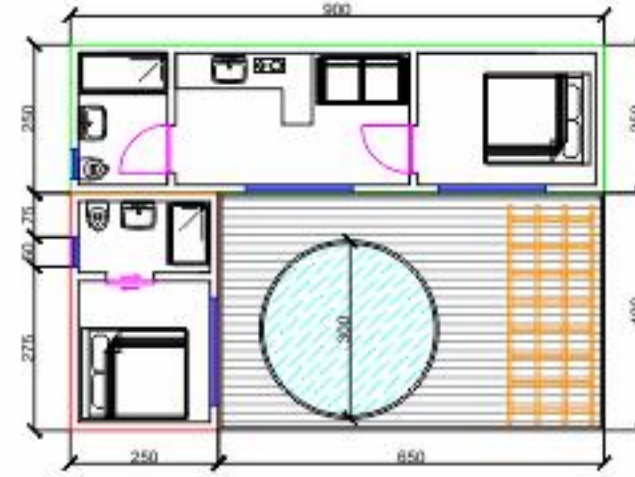

<b>NET KULLANIM ALANI</b>	30,0 m <sup>2</sup>
<b>SINIFI</b>	D2 TİPİ DNAY BELGELİ
<b>ŞAŞI</b>	3-5 mm DALDIRMA GALVANİZ <b>S420 MC ÇELİK</b>
<b>DİNGİL</b>	ÇİFT FRENLİ TORSİYONLU
<b>KAPLİN</b>	KNOOT MARKA
<b>KARKAS</b>	0,8mm kalınlıkta 90x45 mm EBATINDA HAFIF ÇELİK
<b>ÇATI KAPLAMASI</b>	0,5 mm SİNÜS METAL
<b>YALITIM</b>	84 dns MINERAL TAŞYÜNÜ / 8 cm
<b>NEM BARIYERİ</b>	TYVEK
<b>DIŞ CEPHE AHŞAP KAPLAMASI</b>	KUZEY ÇAMI THERMOWOOD
<b>DIŞ CEPHE METAL KAPLAMASI</b>	0,5 mm SİNÜS METAL
<b>DIŞ CEPHE DİĞER KAPLAMASI</b>	-
<b>İÇ CEPHE DUVAR KAPLAMASI</b>	LADİN LAMBRI 16 mm + KİSMİ DEKORATİF LAMBRI + KİSMİ DUVAR KAĞIDI
<b>İÇ CEPHE ZEMİN</b>	SANDVIÇ PANEL 45 mm + LAMİNANT
<b>İÇ CEPHE TAVAN</b>	LADİN LAMBRI 16 mm
<b>BANYO DUVAR</b>	BOARDEX + CTP DECOPAN
<b>BANYO ZEMİN</b>	BOARDEX + CTP DECOPAN
<b>BANYO TAVAN</b>	BOARDEX + CTP DECOPAN
<b>ELEKTRİK TESİSATI</b>	3x2.5/3x1.5/3x6 YANMAZ BORU HATLI HALOJENFREE KABLO
<b>MUTFAK VE BANYO DOLAPLARI</b>	MDFLAM
<b>MUTFAK VE BANYO TEZGAHI</b>	ÇAM MASİF PANEL 20 mm + TİCK YAĞI
<b>MERDİVEN ALTI DOLAPLARI</b>	-
<b>MERDİVEN BASAMAKLARI</b>	-
<b>İÇ AYDINLATMA</b>	SPOT
<b>DIŞ AYDINLATMA</b>	DUVAR TİPİ APLİK
<b>DOĞRAMA</b>	PVC ANTRASİT
<b>CAM</b>	4+16+4 ISICAM
<b>İÇ KAPI</b>	MDF PANEL KAPI
<b>AKILLI EV TEKNOLOJİSİ</b>	OPSİYONEL
<b>SOLAR ENERJİ SİSTEMİ</b>	OPSİYONEL
<b>ELEKTRİKLİ YERDEN ISITMA</b>	OPSİYONEL
<b>VERANDA</b>	-
<b>İÇ DONATI</b>	FİRİN + İKİLİ OCAK + MİNİ BUZDOLABI + TV + KLİMA + KOLTUK + YATAK



## EKOLOJİK / SAĞLAM / DOĞAL AHSAP ÜRÜNLER

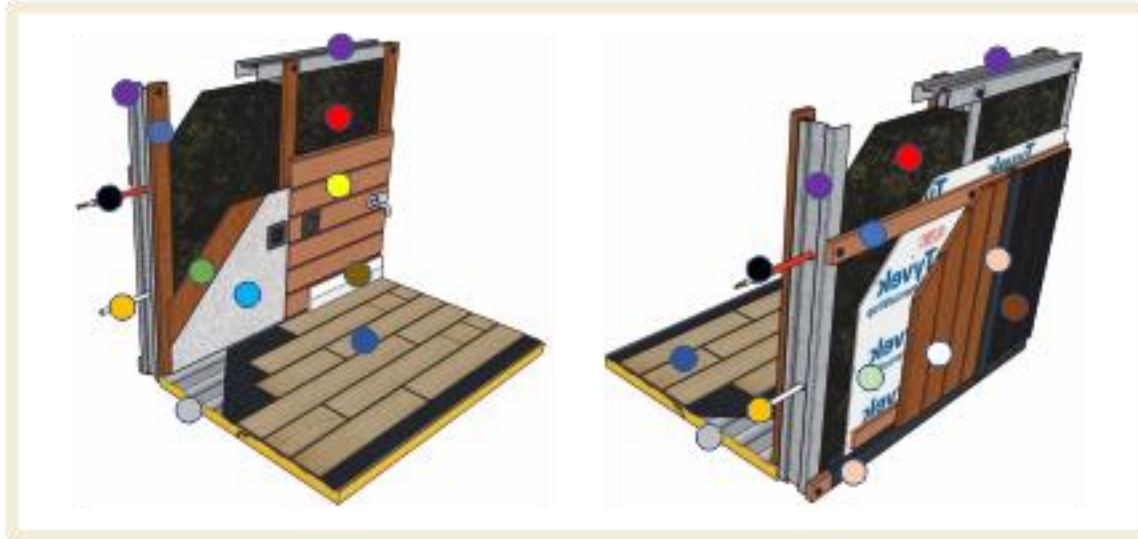

- 45 mm Sandviç Panel (poliüretan)
- 5 mm Kapron + 8 mm Ahşap Laminant
- Yangın Koruyucu Kılıf ve Halojenfree Elektrik Kablosu
- 45 x 90 / 0.8 mm Galvaniz Çelik
- 18 x 50 mm Ahşap Çita
- PPRC Sıcak ve Soğuk Su borusu
- 8 mm Ham MDF
- Nem Bariyeri
- 0.5 mm Metal Birleşim Detayları
- Duvar Kağıdı
- 80 mm 50 dns Mineral Taşyünü
- 16 mm Ladin Lambri
- 20 mm Ladin Thermowood
- Süpürgelik
- 0.5 mm KENET/SİNÜS Metal

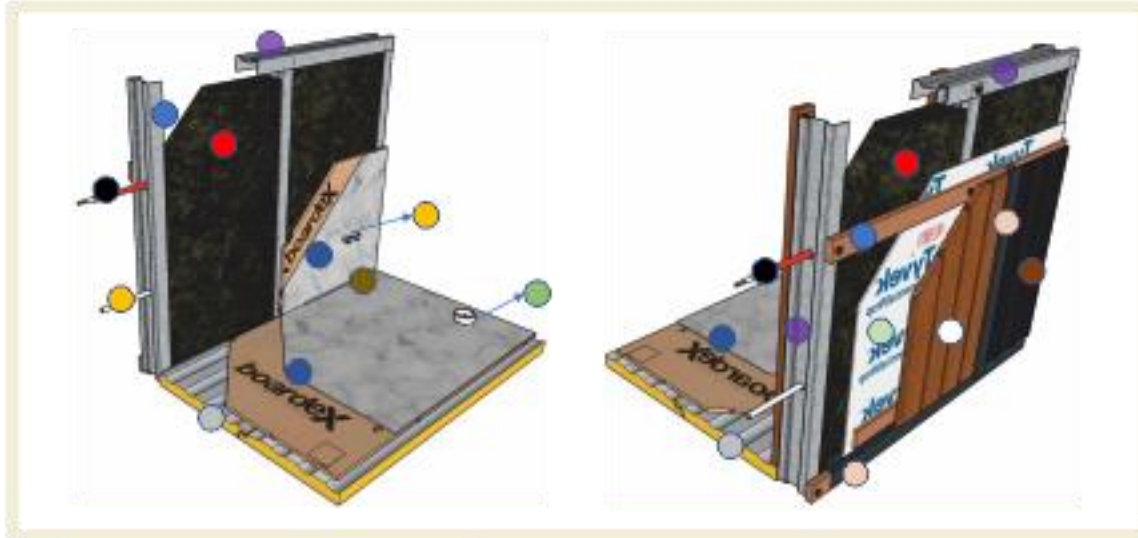

- 45 mm Sandviç Panel (poliüretan)
- 12 mm Boardex + 5 mm CTP
- Yangın Koruyucu Kılıf ve Halojenfree Elektrik Kablosu
- 45 x 90 / 0.8 mm Galvaniz Çelik
- 0.5 mm Metal Birleşim Detayları
- PVC Boru Atık Su
- Nem Bariyeri
- PPRC Sıcak ve Soğuk Su borusu
- 80 mm 50 dns Mineral Taşyünü
- 18 x 50 mm Ahşap Çita
- 20 mm Ladin Thermowood
- Elastik Su Dayanımlı Derz
- 0.5 mm KENET/SİNÜS Metal

## RÖMORK

Uzunluk 4-5-6-7-8-9-10 m  
Genişlik 2,50 m  
Yükseklik ≤ 0.60 m

Römorklarımız Namur, Belçika merkezli SPW Mobilité Infrastructures tarafından verilen O2 Avrupa Tip Onay Belgesi'ne sahiptir. Bu belge, römorkların 2018/858 Treyler yönetmeliğine uygun olarak üretildiğini garanti eder.

Römorklar Türkiye ve Avrupa karayollarında sorunsuz olarak kullanılabilir. Üretim sırasında, S 420 MC 3mm alaşımlı korozyon direnci yüksek hot dip galvanizli yapısal çelik konstrüksiyon kullanılmaktadır. CE belgeli markalardan, Knott marka Kaplin, CYR Jant lastik 13 c sınıfı Dingil, KNOT ve ALKO frenli 3.500 kg taşıma kapasiteli torsiyonlu çift dingil sistemi ve komponentleri kullanılmaktadır.

EKSADO üretimi Tiny House çelik konstrüksiyonları, bilgisayar kontrollü tam otomatik Rollform Hatlarında kaynaklız (Civatalı) yapı teknolojisi ile 4, 5, 6, 7, 8, 9 ve 10 m uzunluklarında 2,50 m genişliğinde ve zeminden en yüksek noktası 4m yüksekliğine kadar üretilir. Ruhsatta O2 çift dingil RÖMORK / ÇEKME Karavan olarak geçer.



## 0.8 mm HAFİF ÇELİK KARKAS

EKSADO Tiny House karkasları, mevcut projelerimizden veya projenize özel olarak C ve U kesitli çeliklerden imal edilir. Bu profiller korozyon direnci yüksek elektro galvaniz kaplamalıdır. Böylece zaman içerisinde paslanmaz veya çürümez.

Kullanılan çelik kalitesi sınıfı Yapısal Çeliktir. EKSADO, çelik karkaslar tamamen kaynaklız ve akıllı vida birleşimlidir ve demonte edilebilir. Ayrıca, her bir profil üzerine lazer yazıcı ile otomatik markalama yapılır ve tesisat boşlukları ihtiyaçlarınıza uygun olarak CNC kontrollü olarak açılır.

EKSADO Çelik Karkasınızı isteğinize göre demonte panel veya römorkunuz üzerine montaj edilmiş halde teslim alabilirsiniz.



DÖRT MEVSİM DOĞA



DOĞA



HUZUR



EKOLOJİK  
SAĞLAM  
DOĞAL  
AHSAP ÜRÜNLER



MUTLULUK

[www.eksado.com](http://www.eksado.com)

AHŞAP EV  
TINY HOUSE  
ŞASI-KARKAS

