 /eksadobuy

 /eksadoburada

 /eksado



WOODEN HOUSE
TINY HOUSE
CHASSIS-CARCASE
www.eksado.com



WEB



INSTAGRAM



Kozluk District D-100 Yanyol Street
No.12 Erenler / Sakarya / Turkey



+90 533 307 75 86



info@eksado.com
www.eksado.com





EKSADO

ECOLOGICAL
DURABLE
NATURAL
WOOD PRODUCTS

EKSADO

EKSADO takes its name from the combination of the original letters of its ECological, SOLid, NATural words. (In Turkish version) Our location is in Sakarya, Turkey.

We produce more than 70 people in our 10,000 m² factory. Within this staff there are Architects, Engineers and very valuable craftsmen. Our company, which started with the production of natural wooden houses when it was founded, is now mainly producing tiny houses. We are in a leading position in the Turkish sector with strong technical staff and master of their business.

We have the capacity to produce 35 tiny houses per month in our factory, which works at full capacity every month and doubles itself day by day. Moreover, in addition to the existing models, we continue to make a difference in the sector with custom designs.

Each of the projects that we have completed and continued domestically and abroad is a reference and a work we are proud of. Thanks to our quality-oriented progress, the name of trust and the right address is actually EKSADO.

VISIONAS

A company that serves the demands of a changing world, our intention is to continue to bring smiling faces to this world.

We know that this will only happen by leaving a better world to the children and future generations that we see as our tomorrows.

This is why we are inspired by nature and use what is natural. We want to bring our nature-loving customers to nature with the products we make. Because we believe that people who can be a part of nature will understand the value of nature.

As EKSADO family, in line with these goals, we want to be the cause of many smiling faces in the future as in the past with many nature-loving customers all over the world.



EKSADO

MICASA_{MODEL}



MICASA DOUBLE LOFT / 8 m

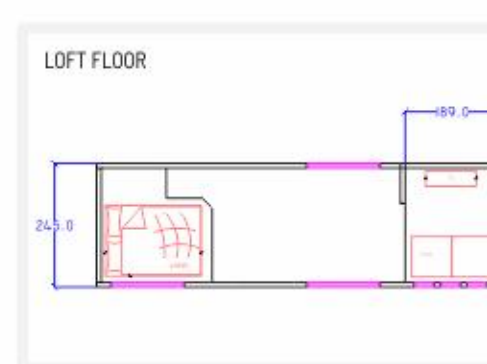
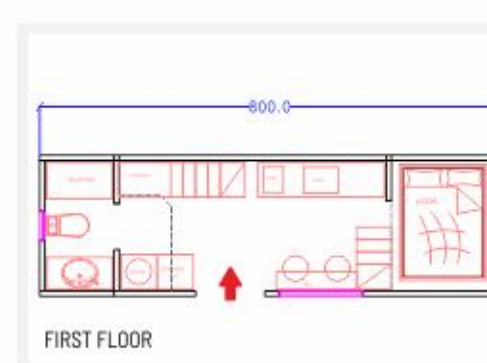
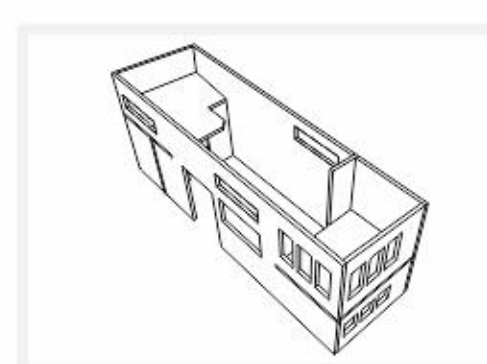
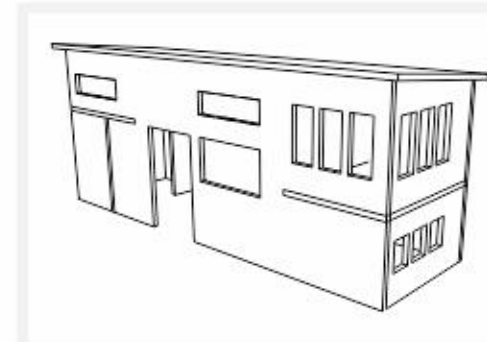

NET USAGE AREA	26,5 m ²
LINE	O2 TYPE APPROVAL CERTIFIED
TRAILER	3-5 mm DIP GALVANIZED S420 MC STEEL
AXLE	DOUBLE BRAKE TORSION AXLE
BRAKE	KNOOT BRAND
FRAME	0,8mm thickness 90x45 mm LIGHT STEEL
ROOFING	0,5 mm SINUS METAL
ISOLATION	50 dns MINERAL ROCKWOOL / 8 cm
MOISTURE BARRIER	TYVEK
EXTERIOR WOOD CLADDING	NORTH PINE THERMOWOOD
EXTERIOR METAL COVERING	0,5 mm SINUS METAL
OTHER FACADE COATING	-
INTERIOR WALL CLADDING	SPRUCE PANELS 16 mm
INTERIOR FLOOR	SANDWICH PANEL 45 mm + LAMINATE
INTERIOR CEILING	SPRUCE PANELS 16 mm
BATH WALL	BOARDEX + CTP DECOPAN
BATH FLOOR	BOARDEX + CTP DECOPAN
BATHROOM CEILING	THERMOWOOD
ELECTRICAL INSTALLATION	3x2.5/3x1.5/3x6 FLAMMABLE PIPELINE HALOGENFREE CABLE
KITCHEN / BATHROOM CABINETS	MDFLAM + PINE MASSIVE PANEL
KITCHEN / BATH COUNTER	PINE MASSIVE PANEL 20 mm + TEAK OIL
UNDER STAIR CABINETS	MDFLAM
STAIR STEPS	PINE MASSIVE PANEL 20 mm + TEAK OIL
INTERIOR LIGHTING	SPOT / AVIZE
OUTDOOR LIGHTING	SPOT
JOINERY	PVC WHITE
GLASS	4+16+4 DOUBLE - GLAZING
INTERIOR DOOR	MDF PANEL DOOR
SMART HOME TECHNOLOGY	OPTIONAL
SOLAR ENERGY SYSTEM	OPTIONAL
ELECTRIC FLOOR HEATING	OPTIONAL
VERANDA	-
INTERIOR EQUIPMENT	MINI FRIDGE, MINI OVEN, DOUBLE INDUCTION COOKER, MINI WASHING MACHINE, BOILER, TV, AIR CONDITIONER, POF FOLDING SEAT, BED

LOS ANGELES MODEL



LOS ANGELES SINGLE LOFT / 9 m

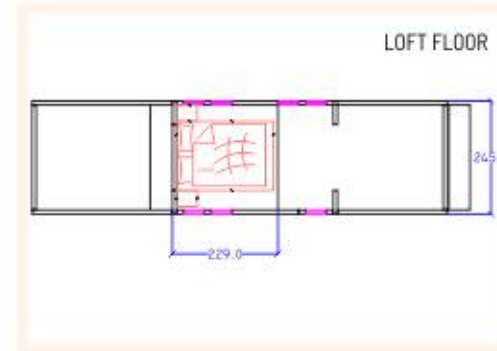
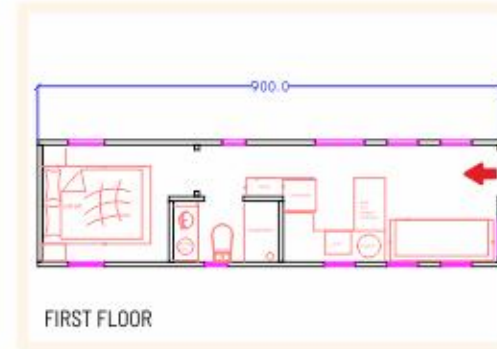
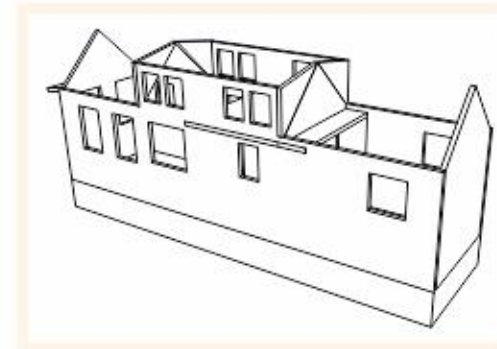

NET USAGE AREA	28.0 m ²
LINE	O2 TYPE APPROVAL CERTIFIED
TRAILER	3-5 mm DIP GALVANIZED S420 MC STEEL
AXLE	DOUBLE BRAKE TORSION AXLE
BRAKE	KNOOT BRAND
FRAME	0,8mm thickness 90x45 mm LIGHT STEEL
ROOFING	0,5 mm SEAM METAL ROOF
ISOLATION	50 dns MINERAL ROCKWOOL / 8 cm
MOISTURE BARRIER	TYVEK
EXTERIOR WOOD CLADDING	PAINTED SPRUCE PANELS 16 mm
EXTERIOR METAL COVERING	0,5 mm SEAM METAL ROOF
OTHER FACADE COATING	-
INTERIOR WALL CLADDING	SPRUCE PANELS 16 mm + PARTIAL DECORATIVE WAINSCOTING + KONTRAPLAK
INTERIOR FLOOR	SANDWICH PANEL 45mm+LAMINATE+FLOOR HEATING
INTERIOR CEILING	SPRUCE PANELS 16 mm
BATH WALL	BOARDEX + CTP DECOPAN
BATH FLOOR	BOARDEX + CTP DECOPAN
BATHROOM CEILING	BOARDEX + CTP DECOPAN
ELECTRICAL INSTALLATION	3x2.5/3x1.5/3x6 FLAMMABLE PIPELINE HALOGENFREE CABLE
KITCHEN / BATHROOM CABINETS	MDFLAM
KITCHEN / BATH COUNTER	PINE MASSIVE PANEL 20 mm + TEAK OIL
UNDER STAIR CABINETS	-
STAIR STEPS	CLIMBING TYPE LADDER
INTERIOR LIGHTING	SPOT
OUTDOOR LIGHTING	WALL SCONCE
JOINERY	PVC ANTHRACITE
GLASS	4+16+4 DOUBLE - GLAZING
INTERIOR DOOR	MDF PANEL DOOR
SMART HOME TECHNOLOGY	OPTIONAL
SOLAR ENERGY SYSTEM	OPTIONAL
ELECTRIC FLOOR HEATING	AVAILABLE
VERANDA	-
INTERIOR EQUIPMENT	BREFRIGERATOR, MINI OVEN, MINI WASHING MACHINE, MINI DISHWASHER, DOUBLE INDUCTION COOKER, BOILER, TV, AIR CONDITIONER, SOFA, BED

nature and you

CALIFORNIA_{MODEL}



CALIFORNIA SINGLE LOFT / 9 m

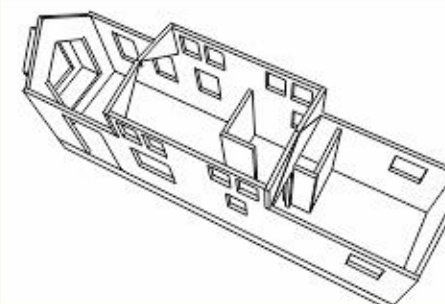
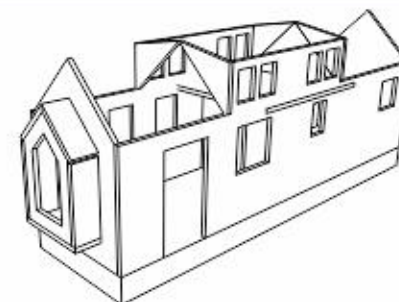

FIRST FLOOR

LOFT FLOOR

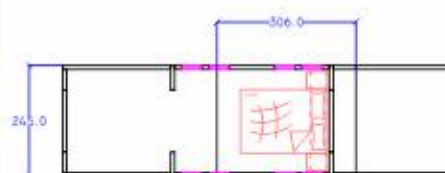

NET USAGE AREA	29,8 m ²
LINE	O2 TYPE APPROVAL CERTIFIED
TRAILER	3-5 mm DIP GALVANIZED S420 MC STEEL
AXLE	DOUBLE BRAKE TORSION AXLE
BRAKE	KNOOT BRAND
FRAME	0,8mm thickness 90x45 mm LIGHT STEEL
ROOFING	0,5 mm SEAM METAL ROOF
ISOLATION	50 dns MINERAL ROCKWOOL / 8 cm
MOISTURE BARRIER	TYVEK
EXTERIOR WOOD CLADDING	PAINTED SPRUCE PANELS 16 mm
EXTERIOR METAL COVERING	0,5 mm TRAPEZ METAL
OTHER FACADE COATING	-
INTERIOR WALL CLADDING	SPRUCE PANELS 16 mm + PARTIAL DECORATIVE WAINSCOT
INTERIOR FLOOR	SANDWICH PANEL 45mm+LAMINATE
INTERIOR CEILING	SPRUCE PANELS 16 mm
BATH WALL	BOARDEX + CTP DECOPAN
BATH FLOOR	BOARDEX + CTP DECOPAN
BATHROOM CEILING	BOARDEX + CTP DECOPAN
ELECTRICAL INSTALLATION	3x2.5/3x1.5/3x6 FLAMMABLE PIPELINE HALOGENFREE CABLE
KITCHEN / BATHROOM CABINETS	MDFLAM
KITCHEN / BATH COUNTER	PINE MASSIVE PANEL 20 mm + TEAK OIL
UNDER STAIR CABINETS	-
STAIR STEPS	CLIMBING TYPE LADDER
INTERIOR LIGHTING	SPOT
OUTDOOR LIGHTING	WALL SCONCE
JOINERY	PVC ANTHRACITE
GLASS	4+16+4 DOUBLE - GLAZING
INTERIOR DOOR	MDF PANEL DOOR
SMART HOME TECHNOLOGY	OPTIONAL
SOLAR ENERGY SYSTEM	OPTIONAL
ELECTRIC FLOOR HEATING	OPTIONAL
VERANDA	-
INTERIOR EQUIPMENT	MINI REFRIGERATOR, DOUBLE INDUCTION COOKER, BOILER, BOILER, TV, AIR CONDITIONER, ELECTRIC FIREPLACE, SMART PANEL, SOFA, BED

nature and you

BERLIN MODEL



BERLIN SINGLE LOFT / 8 m

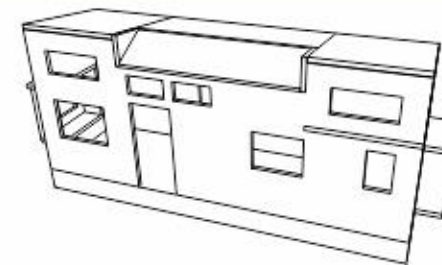
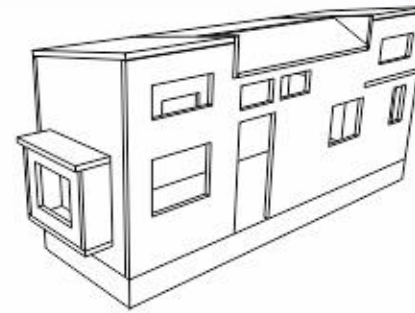

FIRST FLOOR



LOFT FLOOR

NET USAGE AREA	24,0 m ²
LINE	O2 TYPE APPROVAL CERTIFIED
TRAILER	3-5 mm DIP GALVANIZED S420 MC STEEL
AXLE	DOUBLE BRAKE TORSION AXLE
BRAKE	KNOOT BRAND
FRAME	0,8mm thickness 90x45 mm LIGHT STEEL
ROOFING	0,5 mm SEAM METAL ROOF
ISOLATION	50 dns MINERAL ROCKWOOL / 8 cm
MOISTURE BARRIER	TYVEK
EXTERIOR WOOD CLADDING	PAINTED SPRUCE PANELS 16 mm
EXTERIOR METAL COVERING	0,5 mm SEAM METAL ROOF
OTHER FACADE COATING	-
INTERIOR WALL CLADDING	WALLPAPER + PARTIAL SPRUCE PANELS 16 mm
INTERIOR FLOOR	SANDWICH PANEL 45 mm + LAMINATE + FLOOR HEATING
INTERIOR CEILING	SPRUCE PANELS 16 mm
BATH WALL	BOARDEX + CTP DECOPAN
BATH FLOOR	BOARDEX + CTP DECOPAN
BATHROOM CEILING	BOARDEX + CTP DECOPAN
ELECTRICAL INSTALLATION	3x2.5/3x1.5/3x6 FLAMMABLE PIPELINE HALOGENFREE CABLE
KITCHEN / BATHROOM CABINETS	MDFLAM
KITCHEN / BATH COUNTER	PINE MASSIVE PANEL 20 mm + TEAK OIL
UNDER STAIR CABINETS	-
STAIR STEPS	ROLLING LIBRARY LADDER
INTERIOR LIGHTING	SPOT / RAY SPOT
OUTDOOR LIGHTING	WALL SCONCE
JOINERY	PVC ANTHRACITE/WOODEN ENTRANCE DOOR
GLASS	4+16+4 DOUBLE - GLAZING
INTERIOR DOOR	MDF PANEL DOOR
SMART HOME TECHNOLOGY	OPTIONAL
SOLAR ENERGY SYSTEM	OPTIONAL
ELECTRIC FLOOR HEATING	AVAILIABLE
VERANDA	-
INTERIOR EQUIPMENT	MINI FRIDGE, MINI WASHING MACHINE, MINI DISHWASHER, MINI OVEN, DOUBLE INDUCTION COOKER, BOILER, AIR CONDITIONER, TV, SOFA, BED, WALL MOUNTED BED

OSLO MODEL



OSLO SINGLE LOFT / 9 m

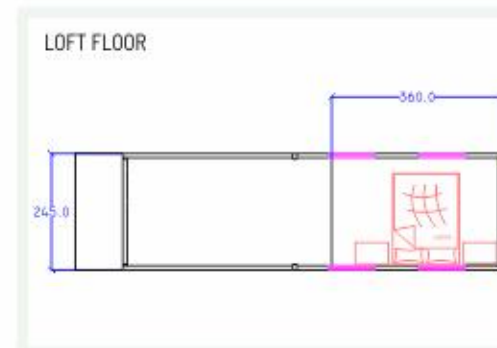
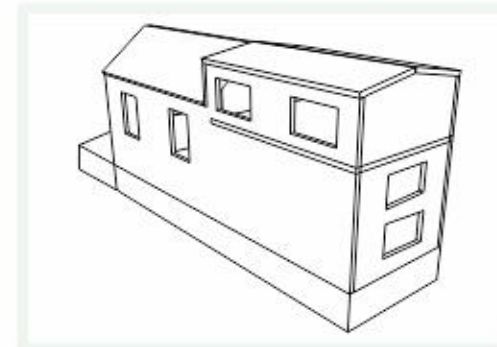
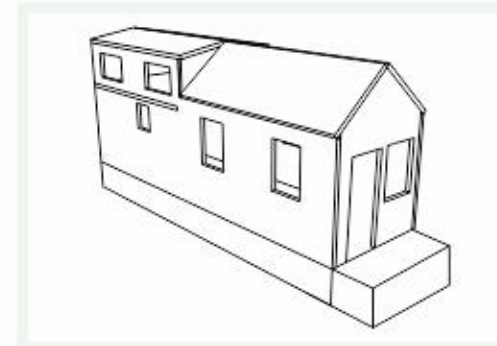

NET USAGE AREA	26,5 m ²
LINE	O2 TYPE APPROVAL CERTIFIED
TRAILER	3-5 mm DIP GALVANIZED S420 MC STEEL
AXLE	DOUBLE BRAKE TORSION AXLE
BRAKE	KNOOT BRAND
FRAME	0,8mm thickness 90x45 mm LIGHT STEEL
ROOFING	0,5 mm SEAM METAL ROOF
ISOLATION	50 dns MINERAL ROCKWOOL / 8 cm
MOISTURE BARRIER	TYVEK
EXTERIOR WOOD CLADDING	PAINTED SPRUCE PANELS 16 mm
EXTERIOR METAL COVERING	-
OTHER FACADE COATING	WHITE COMPOSITE
INTERIOR WALL CLADDING	SPRUCE PANELS 16 mm + PARTIAL DECORATIVE WAINSCOT
INTERIOR FLOOR	SANDWICH PANEL 45 mm + LAMINATE
INTERIOR CEILING	SPRUCE PANELS 16 mm
BATH WALL	BOARDEX + CTP DECOPAN
BATH FLOOR	BOARDEX + CTP DECOPAN
BATHROOM CEILING	BOARDEX + CTP DECOPAN
ELECTRICAL INSTALLATION	3x2.5/3x1.5/3x6 FLAMMABLE PIPELINE HALOGENFREE CABLE
KITCHEN / BATHROOM CABINETS	MDFLAM
KITCHEN / BATH COUNTER	PINE MASSIVE PANEL 20 mm + TEAK OIL
UNDER STAIR CABINETS	MDFLAM
STAIR STEPS	PINE MASSIVE PANEL 20 mm + TEAK OIL / CLIMBING TYPE LADDER
INTERIOR LIGHTING	SPOT
OUTDOOR LIGHTING	WALL SCONCE
JOINERY	PVC WHITE
GLASS	4+16+4 DOUBLE - GLAZING
INTERIOR DOOR	MDF PANEL DOOR
SMART HOME TECHNOLOGY	OPTIONAL
SOLAR ENERGY SYSTEM	OPTIONAL
ELECTRIC FLOOR HEATING	OPTIONAL
VERANDA	WOODEN DECK COATING
INTERIOR EQUIPMENT	FRIDGE, MINI OVEN, MINI DISHWASHER, DOUBLE INDUCTION COOKER, BOILER, TV, AIR CONDITIONER, SOFA, BED

LIZBON MODEL



LIZBON 8 m

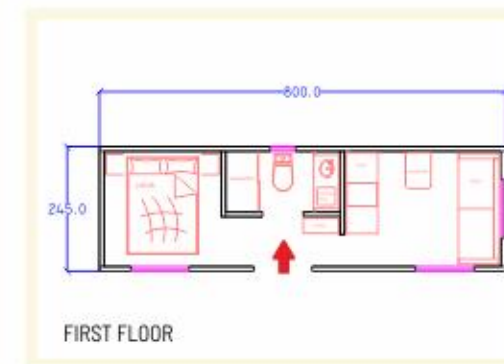
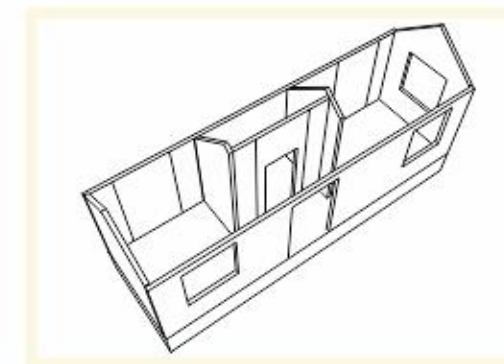
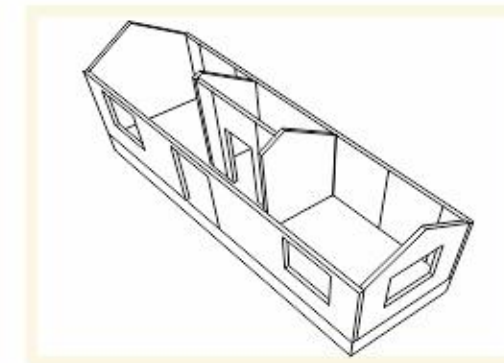

FIRST FLOOR



NET USAGE AREA	17,8 m ²
LINE	O2 TYPE APPROVAL CERTIFIED
TRAILER	3-5 mm DIP GALVANIZED S420 MC STEEL
AXLE	DOUBLE BRAKE TORSION AXLE
BRAKE	KNOOT BRAND
FRAME	0,8mm thickness 90x45 mm LIGHT STEEL
ROOFING	0,5 mm SINUS METAL
ISOLATION	50 dns MINERAL ROCKWOOL / 8 cm
MOISTURE BARRIER	TYVEK
EXTERIOR WOOD CLADDING	PAINTED SPRUCE PANELS 16 mm
EXTERIOR METAL COVERING	-
OTHER FACADE COATING	-
INTERIOR WALL CLADDING	KONTRAPLAK + PARTIAL WALLPAPER
INTERIOR FLOOR	SANDWICH PANEL 45 mm + LAMINATE
INTERIOR CEILING	0,8 mm KONTRAPLAK
BATH WALL	BOARDEX + CTP DECOPAN
BATH FLOOR	BOARDEX + CTP DECOPAN
BATHROOM CEILING	BOARDEX + CTP DECOPAN
ELECTRICAL INSTALLATION	3x2.5/3x1.5/3x6 FLAMMABLE PIPELINE HALOGENFREE CABLE
KITCHEN / BATHROOM CABINETS	MDFLAM
KITCHEN / BATH COUNTER	PINE MASSIVE PANEL 20 mm + TEAK OIL
UNDER STAIR CABINETS	-
STAIR STEPS	-
INTERIOR LIGHTING	SPOT / RAY SPOT
OUTDOOR LIGHTING	WALL SCONCE
JOINERY	PVC ANTHRACITE
GLASS	4+16+4 DOUBLE - GLAZING
INTERIOR DOOR	WOODEN RUSTIC PAINTED DOOR
SMART HOME TECHNOLOGY	OPTIONAL
SOLAR ENERGY SYSTEM	OPTIONAL
ELECTRIC FLOOR HEATING	OPTIONAL
VERANDA	-
INTERIOR EQUIPMENT	MINI FRIDGE, MINI OVEN, MINI WASHING MACHINE, MINI DISHWASHER, DOUBLE INDUCTION COOKER, HEATERS, TV, AIR CONDITIONER, BED, SOFA

LAS VEGAS_{MODEL}



LAS VEGAS 7 m

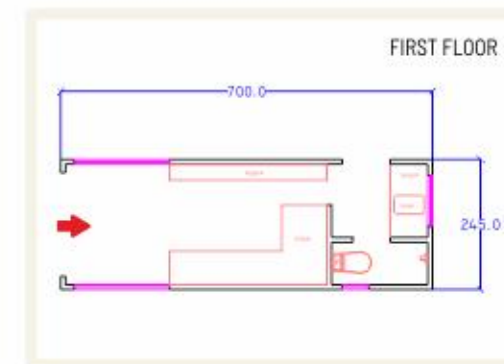
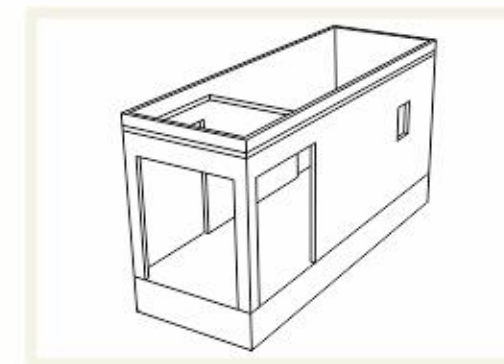
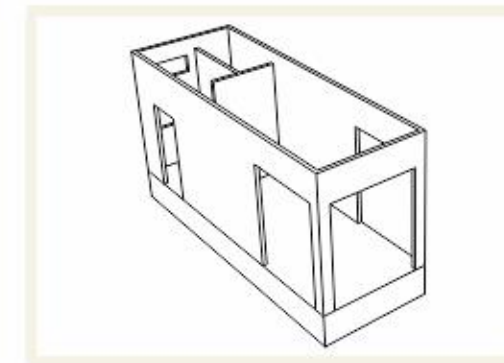

NET USAGE AREA	16,5 m ²
LINE	O2 TYPE APPROVAL CERTIFIED
TRAILER	3-5 mm DIP GALVANIZED S420 MC STEEL
AXLE	DOUBLE BRAKE TORSION AXLE
BRAKE	KNOOT BRAND
FRAME	0,8mm thickness 90x45 mm LIGHT STEEL
ROOFING	0,5 mm SEAM METAL ROOF
ISOLATION	50 dns MINERAL ROCKWOOL / 8 cm
MOISTURE BARRIER	TYVEK
EXTERIOR WOOD CLADDING	-
EXTERIOR METAL COVERING	-
OTHER FACADE COATING	REFLECT ASAŞ BRAND COMPISITE
INTERIOR WALL CLADDING	COTTONWALL TECHNOLOGY
INTERIOR FLOOR	SANDWICH PANEL 45mm+LAMINATE
INTERIOR CEILING	WALPAPER
BATH WALL	BOARDEX + CTP DECOPAN
BATH FLOOR	BOARDEX + CTP DECOPAN
BATHROOM CEILING	BOARDEX + CTP DECOPAN
ELECTRICAL INSTALLATION	3x2.5/3x1.5/3x6 FLAMMABLE PIPELINE HALOGENFREE CABLE
KITCHEN / BATHROOM CABINETS	MDFLAM
KITCHEN / BATH COUNTER	GRANİT
UNDER STAIR CABINETS	-
STAIR STEPS	-
INTERIOR LIGHTING	SPOT / CEILING LIGHTING LED
OUTDOOR LIGHTING	-
JOINERY	PVC ANTHRACITE
GLASS	4+16+4 DOUBLE - GLAZING
INTERIOR DOOR	MDF PANEL DOOR
SMART HOME TECHNOLOGY	AVAILABLE
SOLAR ENERGY SYSTEM	AVAILABLE (3 kW)
ELECTRIC FLOOR HEATING	OPTIONAL
VERANDA	-
INTERIOR EQUIPMENT	MINI REFRIGERATOR, DOUBLE INDUCTION COOKER, BOILER, TV, AIR CONDITIONER, ELECTRIC FIREPLACE, SMART PANEL, SOFA, BED

KOSOVA 1 LOFT MODEL

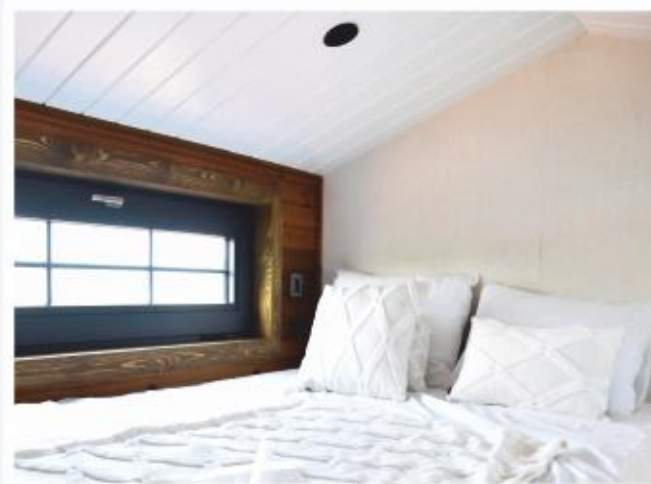

KOSOVA
SINGLE LOFT / 7 m

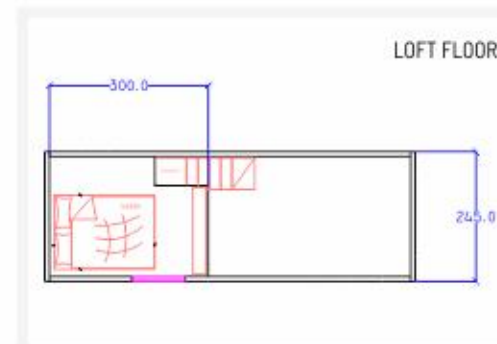
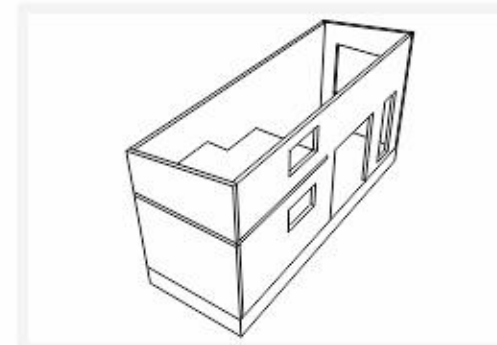
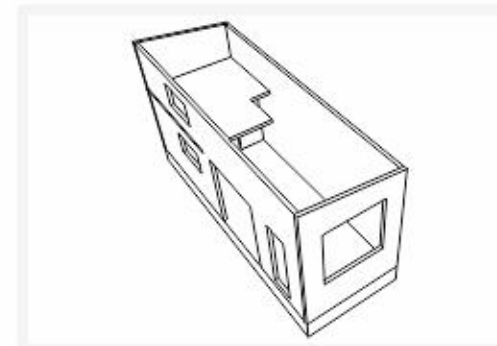

NET USAGE AREA	21,8 m ²
LINE	O2 TYPE APPROVAL CERTIFIED
TRAILER	3-5 mm DIP GALVANIZED S420 MC STEEL
AXLE	DOUBLE BRAKE TORSION AXLE
BRAKE	KNOOT BRAND
FRAME	0,8mm thickness 90x45 mm LIGHT STEEL
ROOFING	0,5 mm SINUS METAL
ISOLATION	50 dns MINERAL ROCKWOOL / 8 cm
MOISTURE BARRIER	TYVEK
EXTERIOR WOOD CLADDING	NORTH PINE THERMOWOOD
EXTERIOR METAL COVERING	0,5 mm SINUS METAL
OTHER FACADE COATING	-
INTERIOR WALL CLADDING	SPRUCE PANELS 16 mm + PARTIAL DECORATIVE WAINSCOT
INTERIOR FLOOR	SANDWICH PANEL 45 mm + LAMINATE
INTERIOR CEILING	SPRUCE PANELS 16 mm
BATH WALL	BOARDEX + CTP DECOPAN
BATH FLOOR	BOARDEX + CTP DECOPAN
BATHROOM CEILING	BOARDEX + CTP DECOPAN
ELECTRICAL INSTALLATION	3x2.5/3x1.5/3x6 FLAMMABLE PIPELINE HALOGENFREE CABLE
KITCHEN / BATHROOM CABINETS	MDFLAM
KITCHEN / BATH COUNTER	PINE MASSIVE PANEL 20 mm + TEAK OIL
UNDER STAIR CABINETS	MDFLAM
STAIR STEPS	PINE MASSIVE PANEL 20 mm + TEAK OIL
INTERIOR LIGHTING	SPOT
OUTDOOR LIGHTING	WALL SCNCE
JOINERY	PVC ANTHRACITE
GLASS	4+16+4 DOUBLE - GLAZING
INTERIOR DOOR	MDF PANEL DOOR
SMART HOME TECHNOLOGY	OPTIONAL
SOLAR ENERGY SYSTEM	OPTIONAL
ELECTRIC FLOOR HEATING	OPTIONAL
VERANDA	-
INTERIOR EQUIPMENT	OVEN, MINI FRIDGE, DOUBLE INDUCTION COOKER, BOILER, TV, AIR CONDITIONER, BED, SOFA

KOSOVA 2 LOFT MODEL



nature and you

KOSOVA DOUBLE LOFT / 8 m

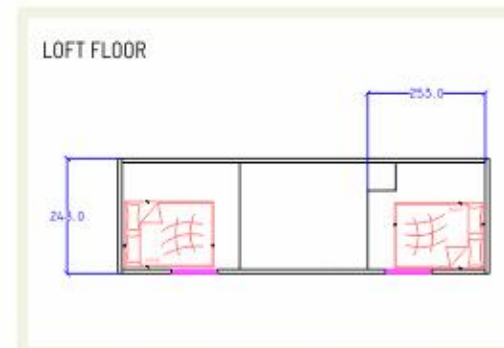
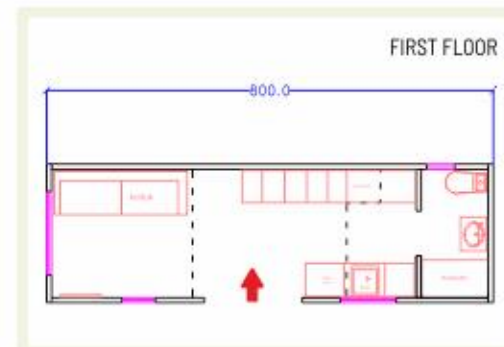
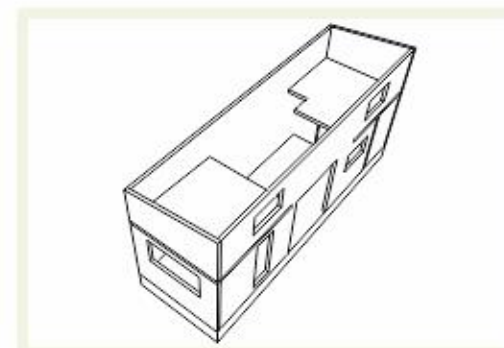
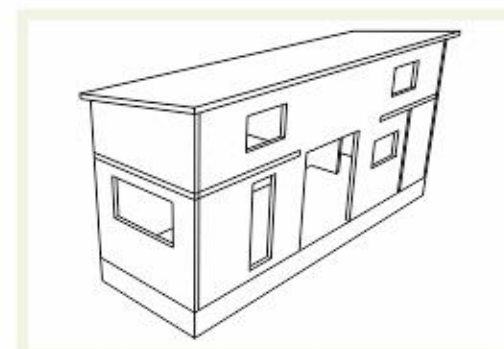

NET USAGE AREA	29,5 m ²
LINE	O2 TYPE APPROVAL CERTIFIED
TRAILER	3-5 mm DIP GALVANIZED S420 MC STEEL
AXLE	DOUBLE BRAKE TORSION AXLE
BRAKE	KNOOT BRAND
FRAME	0,8mm thickness 90x45 mm LIGHT STEEL
ROOFING	0,5 mm SINUS METAL
ISOLATION	50 dns MINERAL ROCKWOOL / 8 cm
MOISTURE BARRIER	TYVEK
EXTERIOR WOOD CLADDING	NORTH PINE THERMOWOOD
EXTERIOR METAL COVERING	0,5 mm SINUS METAL
OTHER FACADE COATING	-
INTERIOR WALL CLADDING	SPRUCE PANELS 16 mm + PARTIAL DECORATIVE WAINSCOTING
INTERIOR FLOOR	SANDWICH PANEL 45 mm + LAMINATE
INTERIOR CEILING	SPRUCE PANELS 16 mm
BATH WALL	BOARDEX + CTP DECOPAN
BATH FLOOR	BOARDEX + CTP DECOPAN
BATHROOM CEILING	BOARDEX + CTP DECOPAN
ELECTRICAL INSTALLATION	3x2.5/3x1.5/3x6 FLAMMABLE PIPELINE HALOGENFREE CABLE
KITCHEN / BATHROOM CABINETS	MDFLAM
KITCHEN / BATH COUNTER	PINE MASSIVE PANEL 20 mm + TEAK OIL
UNDER STAIR CABINETS	MDFLAM
STAIR STEPS	PINE MASSIVE PANEL 20 mm + TEAK OIL
INTERIOR LIGHTING	SPOT
OUTDOOR LIGHTING	WALL SCONCE
JOINERY	PVC ANTHRACITE
GLASS	4+16+4 DOUBLE - GLAZING
INTERIOR DOOR	MDF PANEL DOOR
SMART HOME TECHNOLOGY	OPTIONAL
SOLAR ENERGY SYSTEM	OPTIONAL
ELECTRIC FLOOR HEATING	OPTIONAL
VERANDA	-
INTERIOR EQUIPMENT	OVEN, MINI FRIDGE, DOUBLE INDUCTION COOKER, BOILER, TV, AIR CONDITIONER, BED, SOFA

ORANGE WAGOON_{MODEL}



ORANGE WAGOON SINGLE LOFT / 8 m

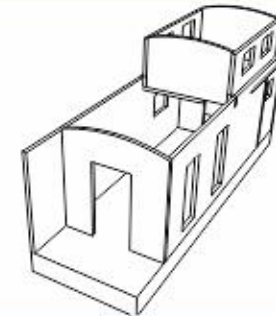
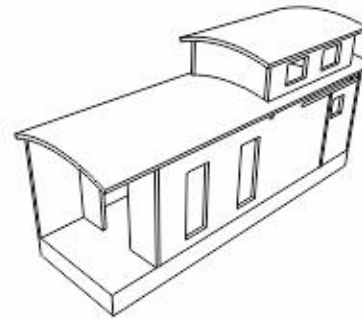

FIRST FLOOR

LOFT FLOOR



NET USAGE AREA	24,5 m ²
LINE	O2 TYPE APPROVAL CERTIFIED
TRAILER	3-5 mm DIP GALVANIZED S420 MC STEEL
AXLE	DOUBLE BRAKE TORSION AXLE
BRAKE	KNOOT BRAND
FRAME	0,8mm thickness 90x45 mm LIGHT STEEL
ROOFING	0,5 mm SINUS METAL
ISOLATION	50 dns MINERAL ROCKWOOL / 8 cm
MOISTURE BARRIER	TYVEK
EXTERIOR WOOD CLADDING	NORTH PINE THERMOWOOD
EXTERIOR METAL COVERING	0,5 mm SINUS METAL
OTHER FACADE COATING	-
INTERIOR WALL CLADDING	WALLPAPER + PARTIAL SPRUCE PANELS 16 mm + PARTIAL DECORATIVE WAINSCOTING
INTERIOR FLOOR	SANDWICH PANEL 45 mm + LAMINATE
INTERIOR CEILING	SPRUCE PANELS 16 mm
BATH WALL	BOARDEX + CTP DECOPAN + THERMOWOOD
BATH FLOOR	BOARDEX + CTP DECOPAN
BATHROOM CEILING	THERMOWOOD
ELECTRICAL INSTALLATION	3x2.5/3x1.5/3x6 FLAMMABLE PIPELINE HALOGENFREE CABLE
KITCHEN / BATHROOM CABINETS	MDFLAM
KITCHEN / BATH COUNTER	PINE MASSIVE PANEL 20 mm + TEAK OIL
UNDER STAIR CABINETS	-
STAIR STEPS	CLIMBING TYPE LADDER
INTERIOR LIGHTING	SPOT / AVIZE
OUTDOOR LIGHTING	WALL SCNCE
JOINERY	PVC ANTHRACITE
GLASS	4+16+4 DOUBLE - GLAZING
INTERIOR DOOR	MDF PANEL DOOR
SMART HOME TECHNOLOGY	OPTIONAL
SOLAR ENERGY SYSTEM	OPTIONAL
ELECTRIC FLOOR HEATING	OPTIONAL
VERANDA	WOODEN DECK COATING
INTERIOR EQUIPMENT	MICROWAVE, MINI FRIDGE, DOUBLE INDUCTION COOKER, BOILER, TV, AIR CONDITIONER, SOFA, BED

*nature
and you*

RED WAGOON_{MODEL}



RED WAGOON SINGLE LOFT / 8 m

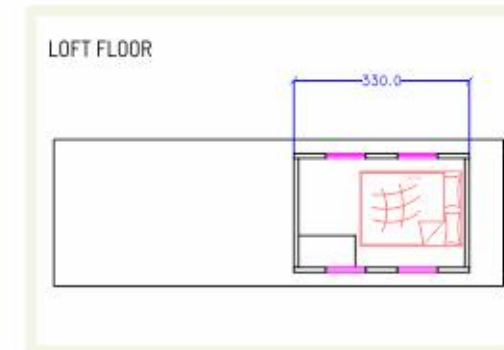
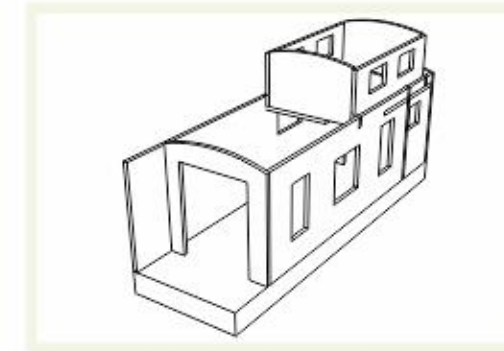
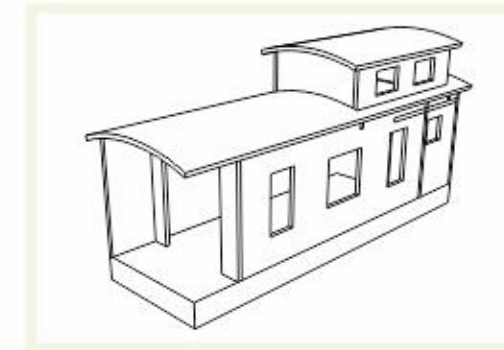

NET USAGE AREA	24,5 m ²
LINE	O2 TYPE APPROVAL CERTIFIED
TRAILER	3-5 mm DIP GALVANIZED S420 MC STEEL
AXLE	DOUBLE BRAKE TORSION AXLE
BRAKE	KNOOT BRAND
FRAME	0,8mm thickness 90x45 mm LIGHT STEEL
ROOFING	0,5 mm SINUS METAL
ISOLATION	50 dns MINERAL ROCKWOOL / 8 cm
MOISTURE BARRIER	TYVEK
EXTERIOR WOOD CLADDING	NORTH PINE THERMOWOOD
EXTERIOR METAL COVERING	0,5 mm SINUS METAL
OTHER FACADE COATING	-
INTERIOR WALL CLADDING	KONTRAPLAK + PARTIAL DECORATIVE WAINSCOTING
INTERIOR FLOOR	SANDWICH PANEL 45 mm + LAMINATE
INTERIOR CEILING	SPRUCE PANELS 16 mm
BATH WALL	BOARDEX + CTP DECOPAN + THERMOWOOD
BATH FLOOR	BOARDEX + CTP DECOPAN
BATHROOM CEILING	BOARDEX + CTP DECOPAN
ELECTRICAL INSTALLATION	3x2.5/3x1.5/3x6 FLAMMABLE PIPELINE HALOGENFREE CABLE
KITCHEN / BATHROOM CABINETS	MDFLAM + WOOD
KITCHEN / BATH COUNTER	PINE MASSIVE PANEL 20 mm + TEAK OIL
UNDER STAIR CABINETS	-
STAIR STEPS	CLIMBING TYPE LADDER
INTERIOR LIGHTING	SPOT / AVIZE
OUTDOOR LIGHTING	WALL SCONCE
JOINERY	PVC ANTHRACITE
GLASS	4+16+4 DOUBLE - GLAZING
INTERIOR DOOR	MDF PANEL DOOR
SMART HOME TECHNOLOGY	OPTIONAL
SOLAR ENERGY SYSTEM	OPTIONAL
ELECTRIC FLOOR HEATING	OPTIONAL
VERANDA	WOODEN DECK COATING
INTERIOR EQUIPMENT	DOUBLE INDUCTION COOKERS, MINI FRIDGES, HEATERS, TV, AIR CONDITIONING, ELECTRIC FIREPLACE, SOFA, BED

nature
and you

HOTEL WAGOON_{MODEL}



HOTEL WAGOON SINGLE LOFT / 8 m

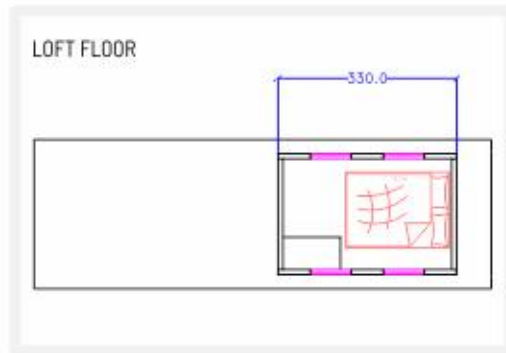
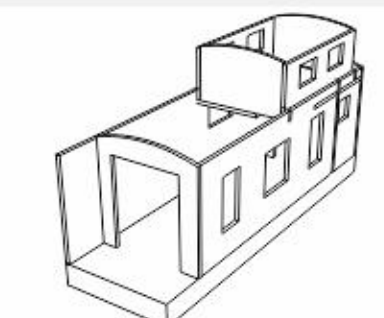
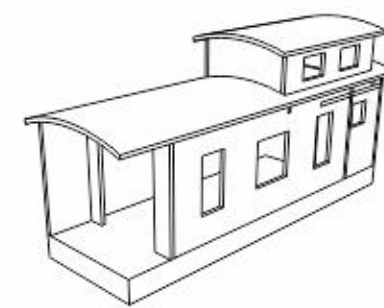

NET USAGE AREA	24,5 m ²
LINE	O2 TYPE APPROVAL CERTIFIED
TRAILER	3-5 mm DIP GALVANIZED S420 MC STEEL
AXLE	DOUBLE BRAKE TORSION AXLE
BRAKE	KNOOT BRAND
FRAME	0,8mm thickness 90x45 mm LIGHT STEEL
ROOFING	0,5 mm SINUS METAL
ISOLATION	50 dns MINERAL ROCKWOOL / 8 cm
MOISTURE BARRIER	TYVEK
EXTERIOR WOOD CLADDING	NORTH PINE THERMOWOOD
EXTERIOR METAL COVERING	0,5 mm SINUS METAL
OTHER FACADE COATING	-
INTERIOR WALL CLADDING	WALLPAPER + PARTIAL DECORATIVE WAINSCOTING
INTERIOR FLOOR	SANDWICH PANEL 45 mm + LAMINATE
INTERIOR CEILING	SPRUCE PANELS 16 mm
BATH WALL	BOARDEX + CTP DECOPAN
BATH FLOOR	BOARDEX + CTP DECOPAN
BATHROOM CEILING	BOARDEX + CTP DECOPAN
ELECTRICAL INSTALLATION	3x2.5/3x1.5/3x6 FLAMMABLE PIPELINE HALOGENFREE CABLE
KITCHEN / BATHROOM CABINETS	WOOD
KITCHEN / BATH COUNTER	PINE MASSIVE PANEL 20 mm + TEAK OIL
UNDER STAIR CABINETS	-
STAIR STEPS	CLIMBING TYPE LADDER
INTERIOR LIGHTING	SPOT / AVIZE
OUTDOOR LIGHTING	WALL SCONCE
JOINERY	PVC ANTHRACITE
GLASS	4+16+4 DOUBLE - GLAZING
INTERIOR DOOR	MDF PANEL DOOR
SMART HOME TECHNOLOGY	OPTIONAL
SOLAR ENERGY SYSTEM	OPTIONAL
ELECTRIC FLOOR HEATING	OPTIONAL
VERANDA	WOODEN DECK COATING
INTERIOR EQUIPMENT	MINI FRIDGE, WATER, TV, AIR CONDITIONER, SOFA, BED

WAGOON MODEL



nature and you



WAGOON MODEL 8 m

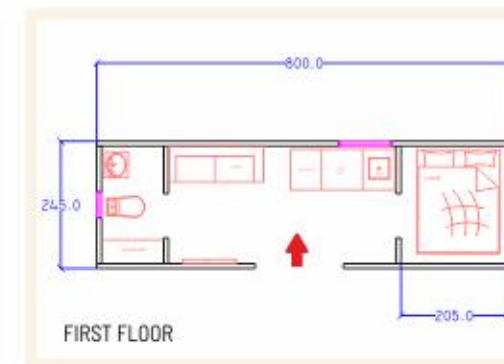
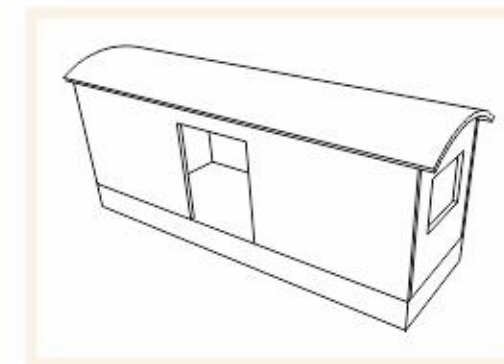
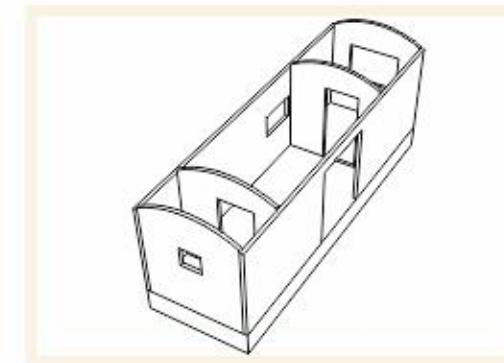

NET USAGE AREA	24,5 m ²
LINE	O2 TYPE APPROVAL CERTIFIED
TRAILER	3-5 mm DIP GALVANIZED S420 MC STEEL
AXLE	DOUBLE BRAKE TORSION AXLE
BRAKE	KNOOT BRAND
FRAME	0,8mm thickness 90x45 mm LIGHT STEEL
ROOFING	0,5 mm SINUS METAL
ISOLATION	50 dns MINERAL ROCKWOOL / 8 cm
MOISTURE BARRIER	TYVEK
EXTERIOR WOOD CLADDING	NORTH PINE THERMOWOOD
EXTERIOR METAL COVERING	0,5 mm SINUS METAL
OTHER FACADE COATING	-
INTERIOR WALL CLADDING	WALLPAPER + PARTIAL DECORATIVE WAINSCOTING
INTERIOR FLOOR	SANDWICH PANEL 45 mm + LAMINATE
INTERIOR CEILING	SPRUCE PANELS 16 mm
BATH WALL	BOARDEX + CTP DECOPAN
BATH FLOOR	BOARDEX + CTP DECOPAN
BATHROOM CEILING	BOARDEX + CTP DECOPAN
ELECTRICAL INSTALLATION	3x2.5/3x1.5/3x6 FLAMMABLE PIPELINE HALOGENFREE CABLE
KITCHEN / BATHROOM CABINETS	WOOD
KITCHEN / BATH COUNTER	PINE MASSIVE PANEL 20 mm + TEAK OIL
UNDER STAIR CABINETS	-
STAIR STEPS	CLIMBING TYPE LADDER
INTERIOR LIGHTING	SPOT / AVIZE
OUTDOOR LIGHTING	WALL SCNCE
JOINERY	PVC ANTHRACITE
GLASS	4+16+4 DOUBLE - GLAZING
INTERIOR DOOR	MDF PANEL DOOR
SMART HOME TECHNOLOGY	OPTIONAL
SOLAR ENERGY SYSTEM	OPTIONAL
ELECTRIC FLOOR HEATING	OPTIONAL
VERANDA	WOODEN DECK COATING
INTERIOR EQUIPMENT	MINI FRIDGE, WATER, TV, AIR CONDITIONER, SOFA, BED

WHITE ISTANBUL MODEL



WHITE ISTANBUL SINGLE LOFT / 8 m

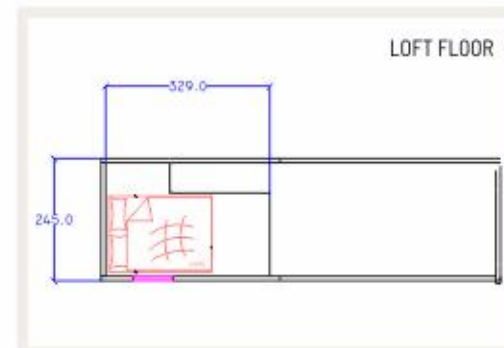
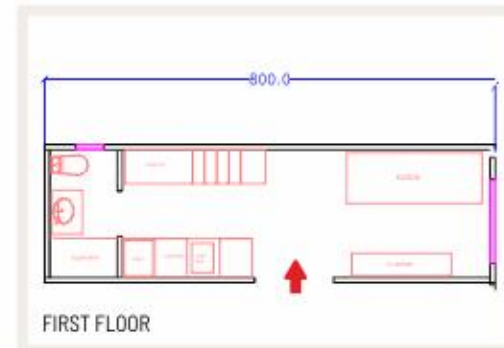
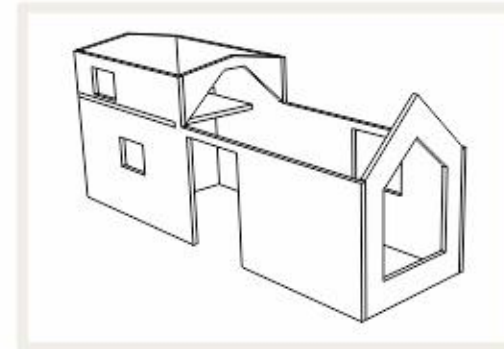

NET USAGE AREA	24,0 m ²
LINE	O2 TYPE APPROVAL CERTIFIED
TRAILER	3-5 mm DIP GALVANIZED S420 MC STEEL
AXLE	DOUBLE BRAKE TORSION AXLE
BRAKE	KNOOT BRAND
FRAME	0,8mm thickness 90x45 mm LIGHT STEEL
ROOFING	0,5 mm SEAM METAL ROOF
ISOLATION	50 dns MINERAL ROCKWOOL / 8 cm
MOISTURE BARRIER	TYVEK
EXTERIOR WOOD CLADDING	NORTH PINE THERMOWOOD
EXTERIOR METAL COVERING	0,5 mm SEAM METAL ROOF
OTHER FACADE COATING	-
INTERIOR WALL CLADDING	WALLPAPER + PARTIAL DECORATIVE WAINSCOT
INTERIOR FLOOR	SANDWICH PANEL 45 mm + LAMINATE
INTERIOR CEILING	SPRUCE PANELS 16 mm
BATH WALL	BOARDEX + CTP DECOPAN + THERMOWOOD
BATH FLOOR	BOARDEX + CTP DECOPAN
BATHROOM CEILING	BOARDEX + CTP DECOPAN
ELECTRICAL INSTALLATION	3x2.5/3x1.5/3x6 FLAMMABLE PIPELINE HALOGENFREE CABLE
KITCHEN / BATHROOM CABINETS	MDFLAM
KITCHEN / BATH COUNTER	PINE MASSIVE PANEL 20 mm + TEAK OIL
UNDER STAIR CABINETS	MDFLAM
STAIR STEPS	PINE MASSIVE PANEL 20 mm + TEAK OIL
INTERIOR LIGHTING	SPOT
OUTDOOR LIGHTING	WALL SCNCE
JOINERY	PVC ANTHRACITE
GLASS	4+16+4 DOUBLE - GLAZING
INTERIOR DOOR	MDF PANEL DOOR
SMART HOME TECHNOLOGY	OPTIONAL
SOLAR ENERGY SYSTEM	OPTIONAL
ELECTRIC FLOOR HEATING	OPTIONAL
VERANDA	-
INTERIOR EQUIPMENT	OVEN, FOUR INDUCTION COOKERS, TV, AIR CONDITIONER, COOKER HOOD, BOILER, MINI FRIDGE, SOFA, BED

ISTANBUL MODEL



İSTANBUL SINGLE LOFT / 8 m

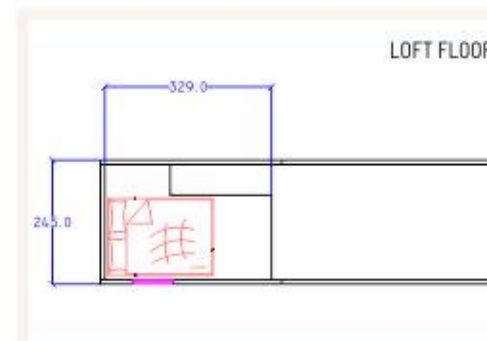
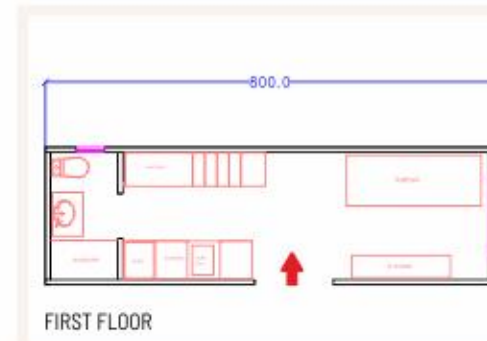
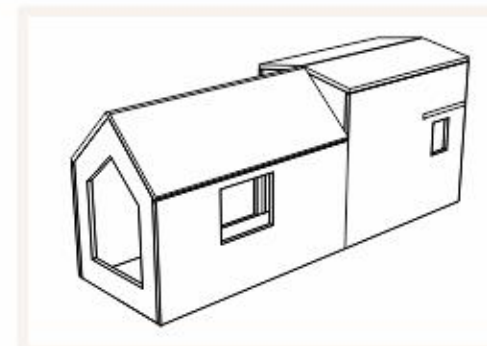
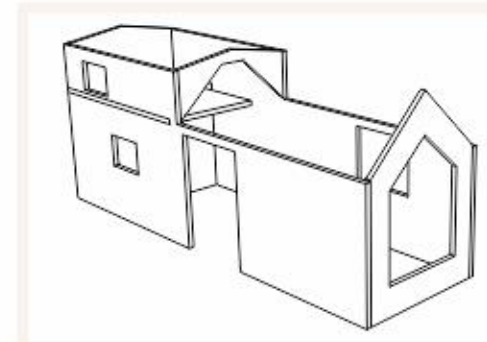

NET USAGE AREA	24,0 m ²
LINE	O2 TYPE APPROVAL CERTIFIED
TRAILER	3-5 mm DIP GALVANIZED S420 MC STEEL
AXLE	DOUBLE BRAKE TORSION AXLE
BRAKE	KNOOT BRAND
FRAME	0,8mm thickness 90x45 mm LIGHT STEEL
ROOFING	0,5 mm SEAM METAL ROOF
ISOLATION	50 dns MINERAL ROCKWOOL / 8 cm
MOISTURE BARRIER	TYVEK
EXTERIOR WOOD CLADDING	NORTH PINE THERMOWOOD
EXTERIOR METAL COVERING	0,5 mm SEAM METAL ROOF
OTHER FACADE COATING	-
INTERIOR WALL CLADDING	SPRUCE WAINSCOT 16 mm
INTERIOR FLOOR	SANDWICH PANEL 45 mm + LAMINATE
INTERIOR CEILING	SPRUCE PANELS 16 mm
BATH WALL	BOARDEX + CTP DECOPAN
BATH FLOOR	BOARDEX + CTP DECOPAN
BATHROOM CEILING	BOARDEX + CTP DECOPAN
ELECTRICAL INSTALLATION	3x2.5/3x1.5/3x6 FLAMMABLE PIPELINE HALOGENFREE CABLE
KITCHEN / BATHROOM CABINETS	MDFLAM
KITCHEN / BATH COUNTER	PINE MASSIVE PANEL 20 mm + TEAK OIL
UNDER STAIR CABINETS	MDFLAM
STAIR STEPS	PINE MASSIVE PANEL 20 mm + TEAK OIL
INTERIOR LIGHTING	SPOT
OUTDOOR LIGHTING	WALL SCNCE
JOINERY	PVC ANTHRACITE
GLASS	4+16+4 DOUBLE - GLAZING
INTERIOR DOOR	MDF PANEL DOOR
SMART HOME TECHNOLOGY	OPTIONAL
SOLAR ENERGY SYSTEM	OPTIONAL
ELECTRIC FLOOR HEATING	OPTIONAL
VERANDA	-
INTERIOR EQUIPMENT	MICROWAVE, DOUBLE INDUCTION COOKER, TV, AIR CONDITIONER, BOILER, MINI FRIDGE, SOFA, BED

ISTANBUL 6 METRE MODEL



nature and you

ISTANBUL SINGLE LOFT / 6 m

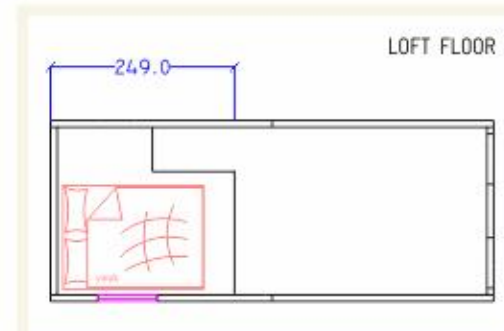
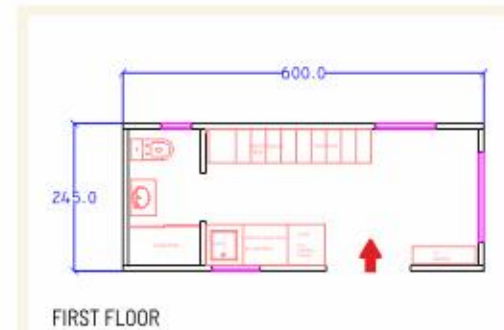
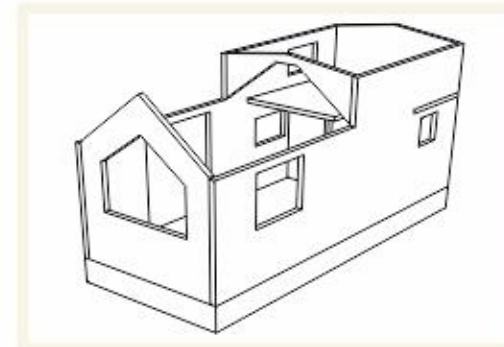
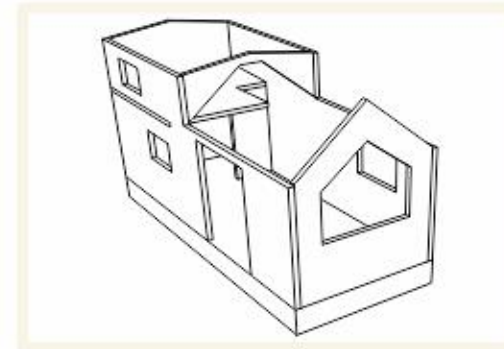

NET USAGE AREA	18,0 m ²
LINE	O2 TYPE APPROVAL CERTIFIED
TRAILER	3-5 mm DIP GALVANIZED S420 MC STEEL
AXLE	DOUBLE BRAKE TORSION AXLE
BRAKE	KNOOT BRAND
FRAME	0,8mm thickness 90x45 mm LIGHT STEEL
ROOFING	0,5 mm SEAM METAL ROOF
ISOLATION	50 dns MINERAL ROCKWOOL / 8 cm
MOISTURE BARRIER	TYVEK
EXTERIOR WOOD CLADDING	NORTH PINE THERMOWOOD
EXTERIOR METAL COVERING	0,5 mm SEAM METAL ROOF
OTHER FACADE COATING	-
INTERIOR WALL CLADDING	KONTRAPLAK + PARTIAL DECORATIVE WINSCOT
INTERIOR FLOOR	SANDWICH PANEL 45 mm + LAMINATE
INTERIOR CEILING	KONTRAPLAK
BATH WALL	BOARDEX + CTP DECOPAN + THERMOWOOD
BATH FLOOR	BOARDEX + CTP DECOPAN
BATHROOM CEILING	BOARDEX + CTP DECOPAN
ELECTRICAL INSTALLATION	3x2.5/3x1.5/3x6 FLAMMABLE PIPELINE HALOGENFREE CABLE
KITCHEN / BATHROOM CABINETS	MDFLAM
KITCHEN / BATH COUNTER	PINE MASSIVE PANEL 20 mm + TEAK OIL
UNDER STAIR CABINETS	MDFLAM
STAIR STEPS	PINE MASSIVE PANEL 20 mm + TEAK OIL
INTERIOR LIGHTING	SPOT
OUTDOOR LIGHTING	WALL SCONCE
JOINERY	PVC ANTHRACITE
GLASS	4+16+4 DOUBLE - GLAZING
INTERIOR DOOR	MDF PANEL DOOR
SMART HOME TECHNOLOGY	OPTIONAL
SOLAR ENERGY SYSTEM	OPTIONAL
ELECTRIC FLOOR HEATING	OPTIONAL
VERANDA	-
INTERIOR EQUIPMENT	MICROWAVE, DOUBLE INDUCTION COOKER, TV, AIR CONDITIONER, BOILER, MINI FRIDGE, MINI DISHWASHER, SOFA, BED

MILKMODEL

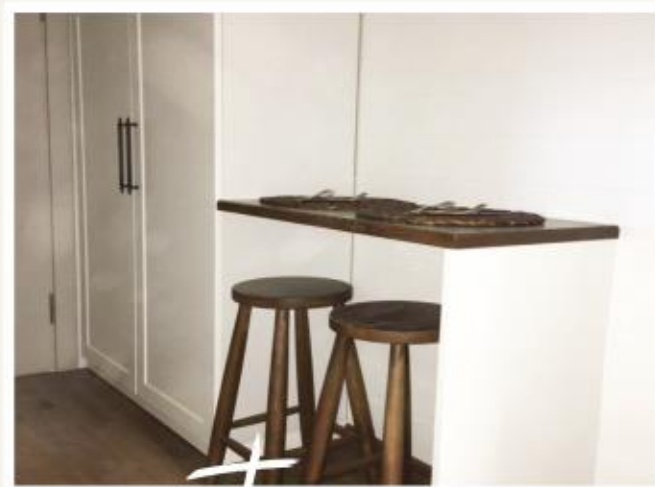

MILK MODEL SINGLE LOFT / 5 m

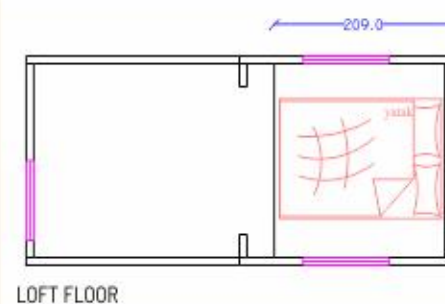
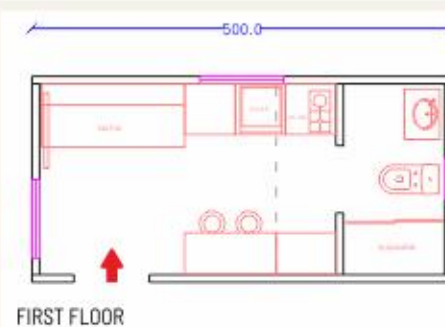
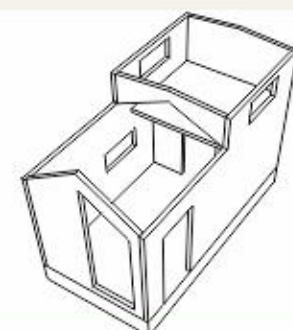
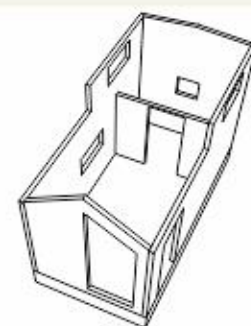

NET USAGE AREA	15,5 m ²
LINE	O2 TYPE APPROVAL CERTIFIED
TRAILER	3-5 mm DIP GALVANIZED S420 MC STEEL
AXLE	DOUBLE BRAKE TORSION AXLE
BRAKE	KNOOT BRAND
FRAME	0,8mm thickness 90x45 mm LIGHT STEEL
ROOFING	0,5 mm SINUS METAL
ISOLATION	50 dns MINERAL ROCKWOOL / 8 cm
MOISTURE BARRIER	TYVEK
EXTERIOR WOOD CLADDING	-
EXTERIOR METAL COVERING	0,5 mm STRAPEZE METAL
OTHER FACADE COATING	-
INTERIOR WALL CLADDING	SPRUCE PANELS 16 mm
INTERIOR FLOOR	SANDWICH PANEL 45 mm + LAMINATE
INTERIOR CEILING	SPRUCE PANELS 16 mm
BATH WALL	BOARDEX + CTP DECOPAN
BATH FLOOR	BOARDEX + CTP DECOPAN
BATHROOM CEILING	BOARDEX + CTP DECOPAN
ELECTRICAL INSTALLATION	3x2.5/3x1.5/3x6 FLAMMABLE PIPELINE HALOGENFREE CABLE
KITCHEN / BATHROOM CABINETS	MDFLAM
KITCHEN / BATH COUNTER	PINE MASSIVE PANEL 20 mm + TEAK OIL
UNDER STAIR CABINETS	-
STAIR STEPS	CLIMBING TYPE LADDER
INTERIOR LIGHTING	SPOT
OUTDOOR LIGHTING	WALL SCNCE
JOINERY	PVC ANTHRACITE
GLASS	4+16+4 DOUBLE - GLAZING
INTERIOR DOOR	MDF PANEL DOOR
SMART HOME TECHNOLOGY	OPTIONAL
SOLAR ENERGY SYSTEM	OPTIONAL
ELECTRIC FLOOR HEATING	OPTIONAL
VERANDA	-
INTERIOR EQUIPMENT	DOUBLE INDUCTION COOKER, MINI FRIDGE, TV, BOILER, AIR CONDITIONER, SOFA, BED

SAUNA MODEL



SAUNA 6 m

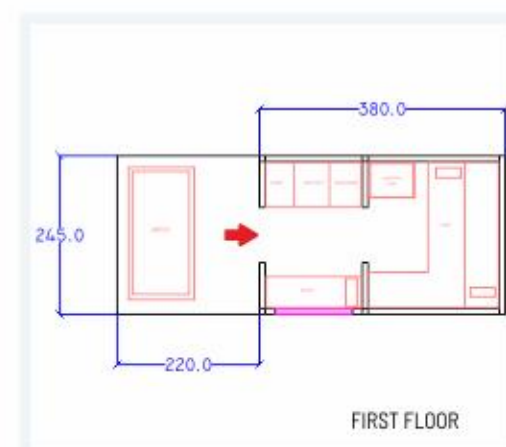
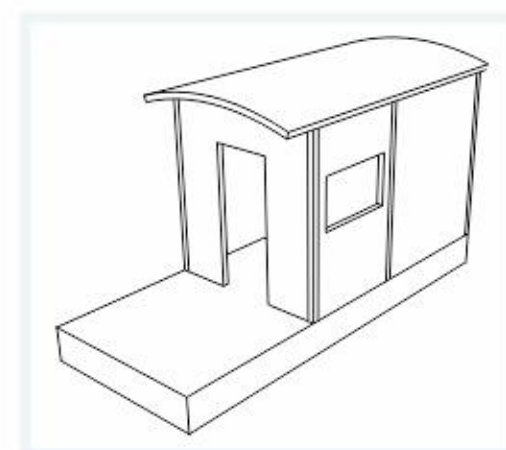

NET USAGE AREA	14,7 m ²
LINE	O2 TYPE APPROVAL CERTIFIED
TRAILER	3-5 mm DIP GALVANIZED S420 MC STEEL
AXLE	DOUBLE BRAKE TORSION AXLE
BRAKE	KNOOT BRAND
FRAME	0,8mm thickness 90x45 mm LIGHT STEEL
ROOFING	0,5 mm SINUS METAL
ISOLATION	POLYURETHANE
MOISTURE BARRIER	-
EXTERIOR WOOD CLADDING	-
EXTERIOR METAL COVERING	-
OTHER FACADE COATING	-
INTERIOR WALL CLADDING	SPRUCE PANELS 16 mm
INTERIOR FLOOR	SANDWICH PANEL+POLYURETHANE+SPRUCE
INTERIOR CEILING	SPRUCE PANELS 16 mm
BATH WALL	-
BATH FLOOR	-
BATHROOM CEILING	-
ELECTRICAL INSTALLATION	3x2.5/3x1.5/3x6 FLAMMABLE PIPELINE HALOGENFREE CABLE
KITCHEN / BATHROOM CABINETS	-
KITCHEN / BATH COUNTER	-
UNDER STAIR CABINETS	-
STAIR STEPS	-
INTERIOR LIGHTING	SPOT / WALL SCNCE
OUTDOOR LIGHTING	WALL SCNCE
JOINERY	PVC JOINERY
GLASS	SATINE CAM
INTERIOR DOOR	ALUMINIUM JOINERY
SMART HOME TECHNOLOGY	OPTIONAL
SOLAR ENERGY SYSTEM	OPTIONAL
ELECTRIC FLOOR HEATING	OPTIONAL
VERANDA	WOODEN DECK COATING
INTERIOR EQUIPMENT	MINI FRIDGE, SAUNA, STOVE, BENCH

nature
and you

PINKY HOUSE_{MODEL}



PINKY HOUSE SINGLE LOFT / 8 m

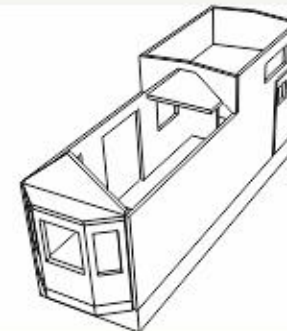
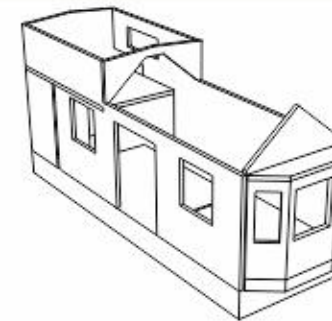

FIRST FLOOR



LOFT FLOOR

NET USAGE AREA	25,7 m ²
LINE	O2 TYPE APPROVAL CERTIFIED
TRAILER	3-5 mm DIP GALVANIZED S420 MC STEEL
AXLE	DOUBLE BRAKE TORSION AXLE
BRAKE	KNOOT BRAND
FRAME	0,8mm thickness 90x45 mm LIGHT STEEL
ROOFING	0,5 mm SEAM METAL ROOF
ISOLATION	50 dns MINERAL ROCKWOOL / 8 cm
MOISTURE BARRIER	TYVEK
EXTERIOR WOOD CLADDING	PAINTED SPRUCE PANELS 16 mm
EXTERIOR METAL COVERING	0,5 mm SEAM METAL ROOF
OTHER FACADE COATING	-
INTERIOR WALL CLADDING	SPRUCE PANELS 16 mm + PARTIAL DECORATIVE WAINSCOT
INTERIOR FLOOR	SANDWICH PANEL 45 mm + LAMINATE
INTERIOR CEILING	SPRUCE PANELS 16 mm
BATH WALL	BOARDEX + CTP DECOPAN
BATH FLOOR	BOARDEX + CTP DECOPAN
BATHROOM CEILING	BOARDEX + CTP DECOPAN
ELECTRICAL INSTALLATION	3x2.5/3x1.5/3x6 FLAMMABLE PIPELINE HALOGENFREE CABLE
KITCHEN / BATHROOM CABINETS	MDFLAM
KITCHEN / BATH COUNTER	PINE MASSIVE PANEL 20 mm + TEAK OIL
UNDER STAIR CABINETS	MDFLAM
STAIR STEPS	PINE MASSIVE PANEL 20 mm + TEAK OIL
INTERIOR LIGHTING	SPOT
OUTDOOR LIGHTING	-
JOINERY	PVC ANTHRACITE
GLASS	4+16+4 DOUBLE - GLAZING
INTERIOR DOOR	MDF PANEL DOOR
SMART HOME TECHNOLOGY	OPTIONAL
SOLAR ENERGY SYSTEM	OPTIONAL
ELECTRIC FLOOR HEATING	OPTIONAL
VERANDA	-
INTERIOR EQUIPMENT	OVEN, FOUR INDUCTION COOKERS, TV, BOILER, MINI FRIDGE, BED, SOFA

BRITISH_{MODEL}



BRITISH DOUBLE LOFT / 8 m

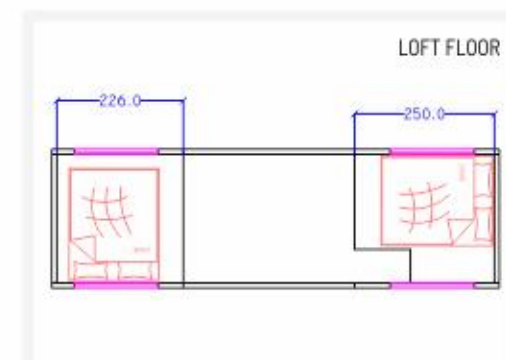
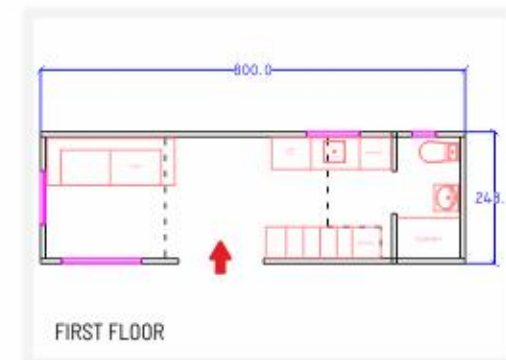
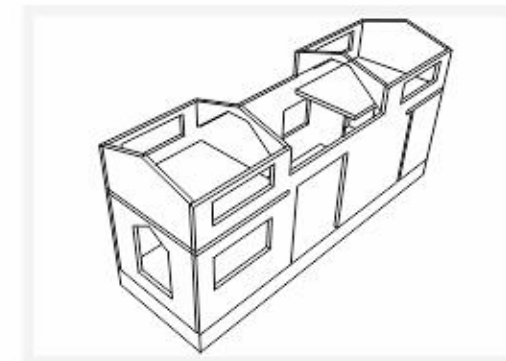

NET USAGE AREA	28,5 m ²
LINE	O2 TYPE APPROVAL CERTIFIED
TRAILER	3-5 mm DIP GALVANIZED S420 MC STEEL
AXLE	DOUBLE BRAKE TORSION AXLE
BRAKE	KNOOT BRAND
FRAME	0,8mm thickness 90x45 mm LIGHT STEEL
ROOFING	0,5 mm SEAM METAL ROOF
ISOLATION	50 dns MINERAL ROCKWOOL / 8 cm
MOISTURE BARRIER	TYVEK
EXTERIOR WOOD CLADDING	NORTH PINE THERMOWOOD
EXTERIOR METAL COVERING	0,5 mm SINUS METAL
OTHER FACADE COATING	-
INTERIOR WALL CLADDING	SPRUCE PANELS 16 mm
INTERIOR FLOOR	SANDWICH PANEL 45 mm + LAMINATE
INTERIOR CEILING	SPRUCE PANELS 16 mm
BATH WALL	BOARDEX + CTP DECOPAN
BATH FLOOR	BOARDEX + CTP DECOPAN
BATHROOM CEILING	BOARDEX + CTP DECOPAN
ELECTRICAL INSTALLATION	3x2.5/3x1.5/3x6 FLAMMABLE PIPELINE HALOGENFREE CABLE
KITCHEN / BATHROOM CABINETS	MDFLAM
KITCHEN / BATH COUNTER	PINE MASSIVE PANEL 20 mm + TEAK OIL
UNDER STAIR CABINETS	MDFLAM
STAIR STEPS	PINE MASSIVE PANEL 20 mm + TEAK OIL
INTERIOR LIGHTING	SPOT
OUTDOOR LIGHTING	WALL SCNCE
JOINERY	PVC ANTHRACITE
GLASS	4+16+4 DOUBLE - GLAZING
INTERIOR DOOR	MDF PANEL DOOR
SMART HOME TECHNOLOGY	OPTIONAL
SOLAR ENERGY SYSTEM	OPTIONAL
ELECTRIC FLOOR HEATING	OPTIONAL
VERANDA	-
INTERIOR EQUIPMENT	OVEN, DOUBLE INDUCTION COOKER, COOKER HOOD, BOILER, AIR CONDITIONER, TV, BED, SOFA

ALAÇATI MODEL (OLD LAHOR)



ALAÇATI SINGLE LOFT / 8 m

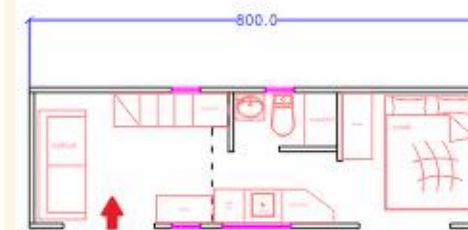
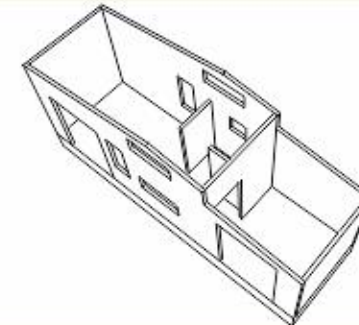
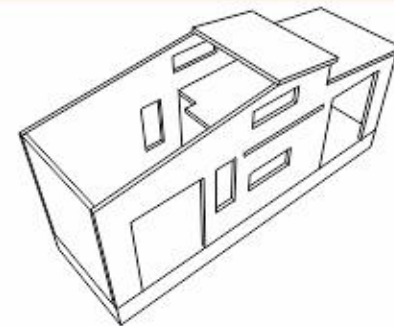

FIRST FLOOR



LOFT FLOOR

NET USAGE AREA	23,0 m ²
LINE	O2 TYPE APPROVAL CERTIFIED
TRAILER	3-5 mm DIP GALVANIZED S420 MC STEEL
AXLE	DOUBLE BRAKE TORSION AXLE
BRAKE	KNOT BRAND
FRAME	0,8mm thickness 90x45 mm LIGHT STEEL
ROOFING	0,5 mm SEAM METAL ROOF
ISOLATION	50 dns MINERAL ROCKWOOL / 8 cm
MOISTURE BARRIER	TYVEK
EXTERIOR WOOD CLADDING	NORTH PINE THERMOWOOD
EXTERIOR METAL COVERING	0,5 mm SEAM METAL ROOF
OTHER FACADE COATING	-
INTERIOR WALL CLADDING	WALLPAPER + PARTIAL DECORATIVE WAINSCOT
INTERIOR FLOOR	SANDWICH PANEL 45 mm + LAMINATE
INTERIOR CEILING	SPRUCE PANELS 16 mm
BATH WALL	BOARDEX + CTP DECOPAN
BATH FLOOR	BOARDEX + CTP DECOPAN
BATHROOM CEILING	BOARDEX + CTP DECOPAN
ELECTRICAL INSTALLATION	3x2.5/3x1.5/3x6 FLAMMABLE PIPELINE HALOGENFREE CABLE
KITCHEN / BATHROOM CABINETS	MDFLAM
KITCHEN / BATH COUNTER	PINE MASSIVE PANEL 20 mm + TEAK OIL
UNDER STAIR CABINETS	MDFLAM
STAIR STEPS	PINE MASSIVE PANEL 20 mm + TEAK OIL
INTERIOR LIGHTING	SPOT
OUTDOOR LIGHTING	WALL SCNCE
JOINERY	PVC ANTHRACITE
GLASS	4+16+4 DOUBLE - GLAZING
INTERIOR DOOR	MDF PANEL DOOR
SMART HOME TECHNOLOGY	OPTIONAL
SOLAR ENERGY SYSTEM	OPTIONAL
ELECTRIC FLOOR HEATING	OPTIONAL
VERANDA	-
INTERIOR EQUIPMENT	MINI OVEN, DOUBLE INDUCTION COOKER, COOKER HOOD, TV, AIR CONDITIONER, MINI FRIDGE, SOFA, BED

*nature
and you*

L TYPE HOTEL MODEL



L TYPE HOTEL MODEL 9 m - 4 m



NET USAGE AREA	30,0 m ²
LINE	O2 TYPE APPROVAL CERTIFIED
TRAILER	3-5 mm DIP GALVANIZED S420 MC STEEL
AXLE	DOUBLE BRAKE TORSION AXLE
BRAKE	KNOOT BRAND
FRAME	0,8mm thickness 90x45 mm LIGHT STEEL
ROOFING	0,5 mm SINUS METAL
ISOLATION	50 dns MINERAL ROCKWOOL / 8 cm
MOISTURE BARRIER	TYVEK
EXTERIOR WOOD CLADDING	NORTH PINE THERMOWOOD
EXTERIOR METAL COVERING	0,5 mm SINUS METAL
OTHER FACADE COATING	-
INTERIOR WALL CLADDING	SPRUCE PANELS 16 mm + PARTIAL DECORATIVE WAINSCOT + PARTIAL WALLPAPER
INTERIOR FLOOR	SANDWICH PANEL 45 mm + LAMINATE
INTERIOR CEILING	SPRUCE PANELS 16 mm
BATH WALL	BOARDEX + CTP DECOPAN
BATH FLOOR	BOARDEX + CTP DECOPAN
BATHROOM CEILING	BOARDEX + CTP DECOPAN
ELECTRICAL INSTALLATION	3x2.5/3x1.5/3x6 FLAMMABLE PIPELINE HALOGENFREE CABLE
KITCHEN / BATHROOM CABINETS	MDFLAM
KITCHEN / BATH COUNTER	PINE MASSIVE PANEL 20 mm + TEAK OIL
UNDER STAIR CABINETS	-
STAIR STEPS	-
INTERIOR LIGHTING	SPOT
OUTDOOR LIGHTING	WALLSCONCE
JOINERY	PVC ANTHRACITE
GLASS	4+16+4 DOUBLE - GLAZING
INTERIOR DOOR	MDF PANEL DOOR
SMART HOME TECHNOLOGY	OPTIONAL
SOLAR ENERGY SYSTEM	OPTIONAL
ELECTRIC FLOOR HEATING	OPTIONAL
VERANDA	-
INTERIOR EQUIPMENT	OVEN, DOUBLE INDUCTION COOKERS, MINI FRIDGE, TV, AIR CONDITIONER, SOFA-BED

nature
and you

ECOLOGICAL / DURABLE / NATURAL WOOD PRODUCTS

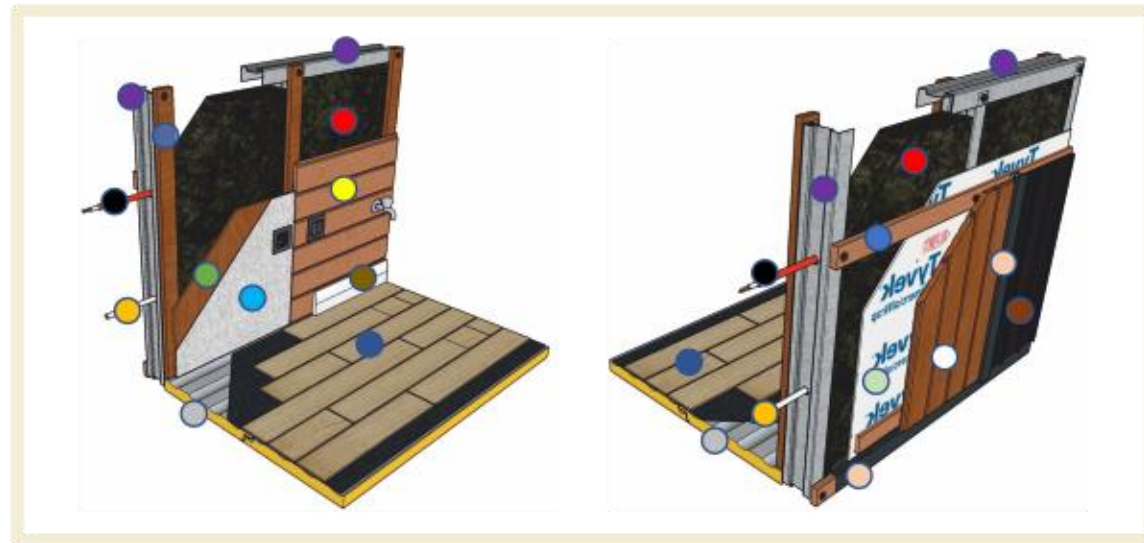

- 45 mm Sandwich Panel (polyurethane)
- 45 x 90 / 0.8 mm Galvanized Steel
- 8 mm Raw MDF
- Wall Paper
- 16 mm Spruce Paneling
- Mopboard
- 5 mm Capron + 8 mm Wood Laminant
- 18 x 50 mm Wood Lath
- Moisture Barrier
- 80 mm 50 dns Mineral Rockwool
- 20 mm Spruce Thermowood
- 0.5 mm SEAM/SINUS Metal
- Fire Protective Sheath and Halogen Free Power Cable
- PPRC Hot / Cold Water Pipes
- 0.5 mm Metal Joint Details

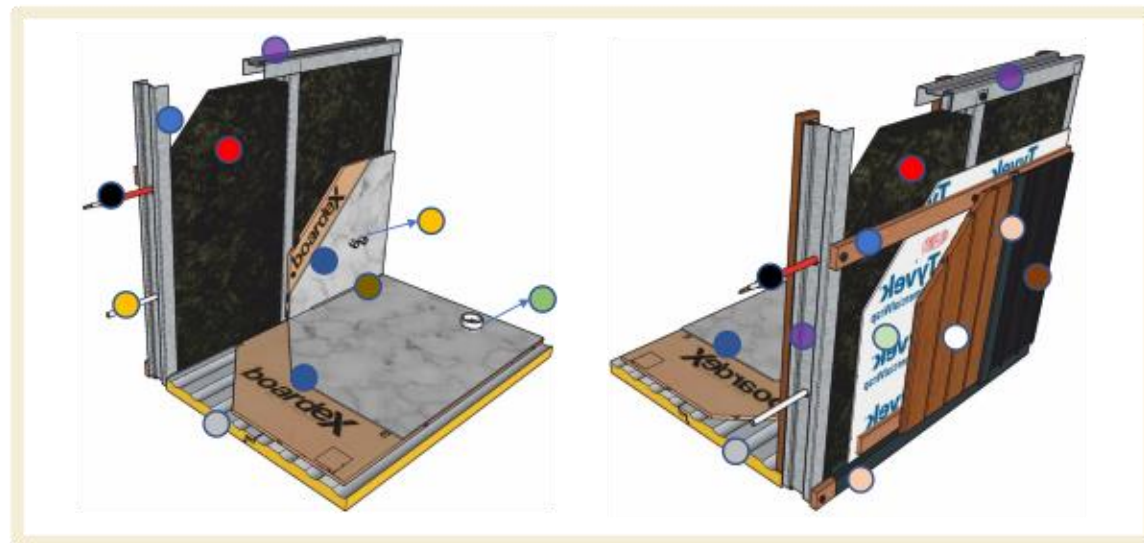

- 45 mm Sandwich Panel (polyurethane)
- 45 x 90 / 0.8 mm Galvanized Steel
- Waste Water Pvc Pipe
- PPRC Hot / Cold Water Pipes
- 18x50 mm Wood Lath
- Elastic Water Resistant Joint
- 12 mm Boardex + 5 mm CTP
- 0.5 mm Metal Joint Details
- Moisture Barrier
- 80 mm 50 dns Mineral Rockwool
- 20 mm Spruce Thermowood
- 0.5 mm SEAM/ SINUS Metal
- Fire Protective Sheath and Halogen Free Power Cable

TRAILER

Length 4-5-6-7-8-9-10 m
 Width 2,50 m
 Height <u>0.60 m</u>

Our trailers have the O2 European Type approval Certificate issued by SPW Mobilité infrastructures based in Namur, Belgium. This document warrants that trailers are manufactured in accordance with the 2018/858 Trailer regulations.

The trailers can be used seamlessly on Turkish and European highways. During production, S 355 MC 3 mm alloy corrosion resistance high hot dip galvanized structural steel construction is used. The CE-certified brands use a Knott brand coupling, CYR Wheel tyre 13c class axle, a torsionised twin axle system and components with a carrying capacity of 3,500 kg with KNOTS and ALKO brakes.

Tiny house steel constructions from EKSADO production, 4, 5, 6, 7, 8 with computer-controlled fully automatic Rollform lines with non-weld (bolted) construction technology, it is produced in lengths of 9 and 10 m, 2.50 m wide and the highest point from the ground up to 4 m high.

In the license, the O2 is referred to as a TWIN axle TRAILER/TOW RV(caravan).



0.8 mm LIGHT STEEL CARCASS

EKSADO tiny House carcasses are made from C and U-section steels, specifically from our existing projects or your project. These profiles are electrogalvanized with a high corrosion resistance. So it does not rust or rot over time.

The grade of steel used is Structural Steel. EKSADO, steel carcasses are completely welded and smart screw combined and can be disassembled. In addition, automatic marking is done with laser printer on each profile and installation gaps are opened CNC controlled to suit your needs. You can receive your EKSADO Steel Wheel as you wish, assembled on a disassembled panel or trailer.

FOUR SEASONS NATURE



NATURE



PEACE



ECOLOGICAL
DURABLE
NATURAL
WOOD PRODUCTS



HAPPINESS

www.eksado.com

WOODEN HOUSE
TINY HOUSE
CHASSIS-CARCASE

