

737 NG

Flight Crew Training Manual

This document has EAR data with Export Control Classification Numbers (ECCN) of: 9E991. Export of this technology is controlled under the United States Export Administration Regulations (EAR) (15 CFR 730-774). An export license may be required before it is used for development, production or use by foreign persons from specific countries. The controller of this data has the individual responsibility to abide by all export laws.

BOEING PROPRIETARY

Copyright © 1999-2021 The Boeing Company. All rights reserved.

Boeing claims copyright in each page of this document only to the extent that the page contains copyrightable subject matter. Boeing also claims copyright in this document as a compilation and/or collective work.

This document includes proprietary information owned by The Boeing Company and/or one or more third parties. Treatment of the document and the information it contains is governed by contract with Boeing. For more information, contact The Boeing Company, P.O. Box 3707, Seattle Washington 98124.

PREPARED BY: _____ (Original signed by)

J. A. Granberg
FCTM Editor

REVIEWED BY: _____ (Original signed by)

G. A. Bulkley
Chief Pilot - Flight Technical & Safety

Document Number: FCT 737 NG (TM)

Revision Number: 20
Revision Date: June 30, 2021

REVIEWED BY: (Original signed by)

R. R. Roberts
Chief Pilot - Flight Standards

REVIEWED BY: (Original signed by)

J. L. Henderson
Chief Pilot - 737

APPROVED BY: (Original signed by)

J. A. Steinnes
Chief Technical Pilot - 737

APPROVED BY: (Original signed by)

C. S. Davis
Director - Commercial Flight Training & Air Crew Operations

CONCURRED BY: (Original signed by)

Removed FAA signature block per request of the FAA. The FCTM is not a regulatory document. Boeing is free to change the FCTM without FAA consideration.

UNCONTROLLED
IF PRINTED



FCTM

Preface	0
Model Identification	0.1
Introduction	0.2
Abbreviations	0.3
Revision Record	0.4
List of Effective Pages	0.5
General Information	1
Ground Operations	2
Takeoff and Initial Climb	3
Climb, Cruise, Descent and Holding	4
Approach and Missed Approach	5
Landing	6
Maneuvers	7
Non-Normal Operations	8
Appendices	A
Operational Information	A.1
Supplemental Information	A.2

Intentionally
Blank

UNCONTROLLED
IF PRINTED



General

The airplane model(s) listed in the table below are covered in this Flight Crew Training Manual.

Model
737-600
737-700
737-800
737-900
737-900ER

Model numbers are used to distinguish information peculiar to one or more, but not all of the airplanes. Where information applies to all models, no reference is made to individual model numbers.

If information is applicable to consecutively numbered models, a dash (–) is used in the model designator. For example, if information is applicable to 737-400 and 737-500 and 737-600 and 737-700 models, the model designator will show 737-400 – 737-700.

If information is applicable to models that are not consecutively numbered, a comma (,) is used in the model designator. For example, if information is applicable to only 737-300 and 737-800 models, the model designator will show 737-300, 737-800.

At this time there is no need for a unique model designator for the 737-700ER because all information that is applicable for the 737-700 also applies to the 737-700ER. If in the future, a need for a 737-700ER designator becomes necessary, it will be added.



Intentionally
Blank

UNCONTROLLED
IF PRINTED



General

The Flight Crew Training Manual (FCTM) provides information and recommendations on maneuvers and techniques, developed and recommended by Boeing, and accepted by the FAA for use in flight operations. These maneuvers and techniques are provided as guidance and do not prevent the operator from developing equivalent maneuvers or techniques in accordance with the applicable operating rules. The manual is divided into eight chapters: General Information; Ground Operations; Takeoff and Initial Climb; Climb, Cruise, Descent and Holding; Approach and Missed Approach; Landing; Maneuvers; and Non-Normal Operations.

General Information covers procedures and techniques not associated with a particular maneuver or phase of flight. Ground Operations covers information associated with airplane preflight, engine starting and taxi operations including taxi operations in adverse weather conditions. Chapters 3 through 6 are titled by phase-of-flight and contain information about airplane operations in each phase. The Maneuvers chapter covers maneuvers associated with climb, cruise, and descent, i.e., approach to stall or stall recovery and rapid descent. The Non-Normal Operations chapter covers non-normal situations that may occur during any phase of flight. Each of the chapters has a preface which describes the chapter in more detail.

This manual also contains two appendices. Appendix A - Section 1, Operational Information is available for the operator to use as desired. It provides a convenient location to supplement the FCTM with operator specific information. Appendix A - Section 2, Supplemental Information contains information for the operations staff of organizations rather than individual pilots. These are considerations for each operator to evaluate and use as they see fit for their operations. The operator may wish to remove this appendix before distributing the manual to their pilots.

Note: In the event of a conflict, the procedures and restrictions published in the FCOM, QRH, MMEL/MEL, or DDG take precedence over the information, techniques, and recommendations in the FCTM.

Note: Figures in this manual are to be used for training purposes only. This data is not suitable as a basis for performance calculations or other engineering purposes.

Note: It is the responsibility of the individual airline to determine applicability of this manual to its operation.

Any questions about the content or use of this manual can be submitted through a Service Request (SR). The Boeing Company will accept initial SRs through the Service Request Application found on the MyBoeingFleet.com portal. To establish an SR Application account, please contact your company's MyBoeingFleet Electronic Access Focal. To establish MyBoeingFleet access, please contact Boeing's Digital Data Customer Support via email.

Email: ddcs@boeing.com

Regulatory Agencies

Regulatory information in this manual is based upon Federal Aviation Administration (FAA) regulations and requirements unless otherwise indicated. Other regulatory agencies may have different regulations and requirements that need to be addressed by non-FAA operators. Examples of regulations and requirements include, but are not limited to, FAR takeoff field requirements, airplane approach categories, and low visibility approach criteria.

Airplane Configuration

The FCTM is intended to provide information in support of procedures listed in the Flight Crew Operations Manual (FCOM) and techniques to help the pilot accomplish these procedures safely and efficiently. The FCTM is written in a format that is more general than the FCOM. It does not account for airplane configuration differences, unless these differences have an impact on the procedure or technique being discussed. For example, the FCTM states, "When the flaps are retracted to the desired position and the airspeed is at or above the flap maneuver speed, ensure CLB thrust is set." This statement is not intended to tell the crew how to set climb thrust, only to emphasize that the flight crew must ensure that CLB thrust is set. It is recognized that crew actions required to set climb thrust are different in different models. Reference to the applicable FCOM is required for information on how to set climb thrust.

In cases where a procedure or technique is applicable only to an airplane with a specific configuration, the annotation "as installed" is used. Airplane configuration differences are found in the FCOM.

**General**

The following abbreviations may be found throughout the manual. Some abbreviations may also appear in lowercase letters. Abbreviations having very limited use are explained in the chapter where they are used.

A	
ACT	Active
ADF	Automatic Direction Finder
ADI	Attitude Director Indicator
ADIRU	Air Data Inertial Reference Unit
AFDS	Autopilot Flight Director System
AFE	Above Field Elevation
AFM	Airplane Flight Manual (FAA approved)
AFM - DPI	Airplane Flight Manual - Digital Performance Information
AGL	Above Ground Level
AH	Alert Height
ALT ACQ	Altitude Acquire
ALT HOLD	Altitude Hold
AMM	Aircraft Maintenance Manual
ANP	Actual Navigation Performance
AOA	Angle of Attack
A/P	Autopilot
APU	Auxiliary Power Unit

AR	Authorization Required
ASA	Autoland Status Annunciator
ASI	Airspeed Indicator
ASR	Airport Surveillance Radar
A/T	Autothrottle
ATC	Air Traffic Control
ATM	Assumed Temperature Method
AUPRTA	Airplane Upset Prevention and Recovery Training Aid.
B	
BARO	Barometric
B/CRS B/C	Back Course
C	
C	Captain Celsius Center
CAA	Civil Aviation Authority
CDFA	Continuous Descent Final Approach
CDU	Control Display Unit
CFIT	Controlled Flight Into Terrain

737 NG Flight Crew Training Manual

CFP	Computer Flight Plan
CFR	Code of Federal Regulations
CG	Center of Gravity
CLB	Climb
CMD	Command
CON	Continuous
CRM	Crew Resource Management
CRT	Cathode Ray Tube
CRZ	Cruise
CWS	Control Wheel Steering
D	
DA	Decision Altitude
DA(H)	Decision Altitude (Height)
D/D	Direct Descent
DDG	Dispatch Deviations Guide
DES	Descent
DIR	Direct
DME	Distance Measuring Equipment
DU	Display Unit
E	
EASA	European Aviation Safety Agency
ECL	Electronic Checklist
ECON	Economy
EEC	Electronic Engine Control
EFB	Electronic Flight Bag

EFIS	Electronic Flight Instrument System
EGT	Exhaust Gas Temperature
EHSI	Electronic Horizontal Situation Indicator
EICAS	Engine Indication and Crew Alerting System
ENG OUT	Engine Out
EOT	Engine Out Taxi
EPR	Engine Pressure Ratio
ETA	Estimated Time of Arrival
ETOPS	Extended Operations
EXT	Extend
F	
F	Fahrenheit
FAC	Final Approach Course
FCOM	Flight Crew Operations Manual
F/D	Flight Director
FAA	Federal Aviation Administration
FAF	Final Approach Fix
FAR	Federal Aviation Regulation
FCC	Flight Control Computer
FLCH	Flight Level Change
FMA	Flight Mode Annunciations
FMC	Flight Management Computer
FMS	Flight Management System
F/O	First Officer

737 NG Flight Crew Training Manual

FOD	Foreign Object Damage or Foreign Object Debris
FPA	Flight Path Angle
FPM	Feet Per Minute
FPV	Flight Path Vector
ft	Foot or Feet
G	
g	free fall acceleration of a body
GA	Go-Around
GBAS	Ground-Based Augmentation System
GLS	GBAS Landing System
GNSS	Global Navigation Satellite System
GP	Glide Path
GPS	Global Positioning System
GPWS	Ground Proximity Warning System
G/S	Glide Slope
GS	Ground Speed
H	
HAA	Height Above Airport
HAT	Height Above Touchdown
HDG SEL	Heading Select
HSI	Horizontal Situation Indicator
HUD	Head Up Display
I	
IAF	Initial Approach Fix

IAN	Integrated Approach Navigation
IAS	Indicated Airspeed
ICAO	International Civil Aviation Organization
IFR	Instrument Flight Rules
IGS	Instrument Guidance System
ILS	Instrument Landing System
IM	Inner Marker
IMC	Instrument Meteorological Conditions
IP	Instructor Pilot
IRS	Inertial Reference System
IRU	Inertial Reference Unit
ISA	International Standard Atmosphere
ISFD	Integrated Standby Flight Display
J	
JAA	Joint Aviation Authority
K	
K	Knots
KCAS	Knots Calibrated Airspeed
KGS	Kilograms
KIAS	Knots Indicated Airspeed
L	
LBS	Pounds
LDA	Localizer-type Directional Aid
LNAV	Lateral Navigation

LOC	Localizer
LOM	Locator Outer Marker
LRC	Long Range Cruise
LVL CHG	Level Change
M	
M	Mach
m	Meters
MAP	Missed Approach Point
MASI	Mach/Airspeed Indicator
MAX	Maximum
MCP	Mode Control Panel
MCT	Maximum Continuous Thrust
MDA(H)	Minimum Descent Altitude (Height)
MEA	Minimum Enroute Altitude
MEL	Minimum Equipment List
MFD	Multifunction Display
MKR	Marker
MM	Middle Marker
MMO	Maximum Mach Operating Speed
MOCA	Minimum Obstruction Clearance Altitude
MOD	Modify
MORA	Minimum Off Route Altitude
MSL	Mean Sea Level
N	
NAA	National Aviation Authority

NAT HLA	North Atlantic High Level Airspace
NAV	Navigation
NAV RAD	Navigation Radio
ND	Navigation Display
NM	Nautical Mile(s)
NNC	Non-Normal Checklist
NNM	Non-Normal Maneuver
NPS	Navigation Performance Scales
N1	Low Pressure Rotor Speed
N2	High Pressure Rotor Speed
O	
OAT	Outside Air Temperature
OM	Outer Marker
OPT	Onboard Performance Tool
P	
PAPI	Precision Approach Path Indicator
PAR	Precision Approach Radar
PF	Pilot Flying
PFD	Primary Flight Display
PI	Performance Inflight
PLI	Pitch Limit Indicator
PMC	Power Management Control
PM	Pilot Monitoring
PWS	Predictive Windshear System

737 NG Flight Crew Training Manual

Q		T	True
QRH	Quick Reference Handbook	TA	Traffic Advisory or Tailored Arrival
R		TACAN	Tactical Air Navigation
RA	Radio Altitude Resolution Advisory	TAS	True Airspeed
RAAS	Runway Awareness and Advisory System	TAT	Total Air Temperature
RAIM	Receiver Autonomous Integrity Monitoring	TCAS	Traffic Alert and Collision Avoidance System
RAT	Ram Air Turbine	TE	Trailing Edge
RCAS	Roll Command Alerting System	TERPS	Terminal Instrument Procedures
RDMI	Radio Distance Magnetic Indicator	TFC	Traffic
RMI	Radio Magnetic Indicator	TO	Takeoff
RNAV	Area Navigation	T/D	Top of Descent
RNP	Required Navigation Performance	TDZE	Touchdown Zone Elevation
RSEP	Rudder System Enhancement Program	TO/GA	Takeoff /Go-Around
RTO	Rejected Takeoff	TR	Traffic Resolution
RVR	Runway Visual Range	TRK	Track
RVSM	Reduced Vertical Separation Minimum	U	
S		U.S.	United States
SAT	Static Air Temperature	V	
SDF	Simplified Directional Facility	VASI	Visual Approach Slope Indicator
SFP	Short Field Performance	VDP	Visual Descent Point
SPD	Speed	VEF	Speed at Engine Failure
STAR	Standard Terminal Arrival Route	VFR	Visual Flight Rules
T		VHF	Very High Frequency
		VLOF	Lift Off Speed
		VMC	Visual Meteorological Conditions

VMCA	Minimum Control Speed Air
VMCG	Minimum Control Speed Ground
VMO	Maximum Operating Speed
VNAV	Vertical Navigation
VOR	VHF Omnidirectional Range
VR	Rotation Speed
VREF	Reference Speed
V/S	Vertical Speed
VSD	Vertical Situation Display
VSI	Vertical Speed Indicator
VTK	Vertical Track
V1	Takeoff Decision Speed
V2	Takeoff Safety Speed
W	
WGS-84	World Geodetic System of 1984
WPT	Waypoint
X	
XTK	Cross Track



Revision Transmittal Letter

To: All holders of the 737 NG Flight Crew Training Manual, Boeing Document Number FCT 737 NG (TM).

Subject: Flight Crew Training Manual Revision.

This revision reflects the most current information available to The Boeing Company 45 days before the subject revision date. The following revision highlights explain changes in this revision. General information below explains the use of revision bars to identify new or revised information.

Revision Record

No.	Revision Date	Date Filed	No.	Revision Date	Date Filed
Initial	April 1, 1999		1	October 31, 2001	
2	October 31, 2002		3	October 31, 2003	
4	October 31, 2004		5	October 31, 2005	
6	October 31, 2006		7	October 31, 2007	
8	October 31, 2008		9	June 30, 2010	
10	July 29, 2011		11	June 30, 2012	
12	June 30, 2013		13	June 30, 2014	
14	June 30, 2015		15	June 30, 2016	
16	June 30, 2017		17	June 30, 2018	
18	June 30, 2019		19	October 30, 2020	
20	June 30, 2021				

General

The Boeing Company issues FCTM revisions to provide new or revised recommendations on maneuvers and techniques, or information supporting changes to FCOM procedures. Revisions may also incorporate appropriate information from previously issued flight operations technical bulletins.

The revision date is the approximate date the manual is approved for printing and posted on MyBoeingFleet (MBF) for customer retrieval. The revision is mailed a few weeks after this date. This manual is effective upon receipt and supersedes any manual (with same document number) with a previous revision number.

Formal revisions include a new Revision Record, Revision Highlights, and a current List of Effective Pages. Use the information on the new Revision Record and List of Effective Pages to verify the Flight Crew Training Manual content.

Pages containing revised technical material have revision bars associated with the changed text or illustration. Editorial revisions (for example, spelling corrections) may have revision bars with no associated highlight.

This revised Flight Crew Training Manual is provided in quantities as specified in each operator's contract.

Additional copies of this manual are available through the Boeing Data and Services Management (DSM) Catalog. This manual is also available in FrameMaker© format for use in airline modification. Advise if information about FrameMaker© format is required.

Filing Instructions

This revision is a complete reprint of the FCTM as indicated on the List of Effective Pages (0.5). Remove all old pages and replace all new pages. However, retain all tabs. There are no replacement tabs included with this revision.

Revision Highlights

This section (0.4) replaces the existing section 0.4 in your manual.

This manual is published from a database; the text and illustrations are marked with configuration information. Occasionally, because database markers are rearranged, or because items are marked with configuration information due to the additions of new database content, some pages may contain revision bars when content appears to be unchanged. Pages may also be republished without revision bars due to slight changes in the flow of the document.



Chapter 1 - General Information

Flight Deck Philosophy

1.2 - Updated Cautions alert based on certification level IAW CFR 14, 25.1322(b), Amendment 38.

1.2 - Clarified statement regarding Advisory level alerts. Standardized verbiage and format. Per flight deck crew operations.

Electronic Flight Bag

1.24 - Non-technical change. Changed "...may wish to..." to "...should...".

Chapter 2 - Ground Operations

Taxi

2.5 - Non-technical change. Clarified statement regarding only intended movement of thrust levers.

Chapter 3 - Takeoff and Initial Climb

Crosswind Takeoff

3.15 - Updated reference to AC 25-32.

Takeoff - Engine Failure

3.39 - Changed "airplane" to "flight path" for clarity.

3.39 - Non-technical change. Re-worded sentence for clarity and standardization; "...a safe altitude has been attained (minimum 400 feet AGL)."

3.39 - Added reference checklist items accomplished by PM as soon as practical. In alignment with latest Engine Fire NNC and FOTB same subject.

Chapter 4 - Climb, Cruise, Descent and Holding

Holding

4.23 - Changed "OM" to "FCOM" for clarity.

4.23 - Changed "OM" to "FCOM" for clarity.

4.23 - Changed "OM" to "FCOM" for clarity.

Chapter 5 - Approach and Missed Approach

ILS or GLS Approach

- 5.20 - Non-technical change. Changed "ILS course" to "localizer course".
- 5.20 - Clarified statement regarding missed approach with no flight director displayed
- 5.20 - Added discussion regarding AFDS.
- 5.22 - Added reference to company specific list of visual references to continue the approach.
- 5.23 - Added reference to company specific AFDS documentation and guidance.
- 5.24 - Changed "internal" to "system" for clarification.
- 5.25 - Clarified TO/GA mode engagement during go-around. Added "follow the missed approach procedure".

Non - ILS Instrument Approaches

- 5.34 - Added "and selected". Radio position updating must be enabled.
- 5.50 - Removed note regarding LPV equipped airplanes. Not applicable.
- 5.57 - Added diagram showing representative approach minimums example.
- 5.57 - Added diagram showing representative approach minimums example.
- 5.57 - Clarification for a "continuous descent final approach IAW AC 120-108 terminology.
- 5.64 - Clarified statement regarding barometric pressure change and set altimeter prior to approach.
- 5.65 - Removed "non-ILS" to clarify statement regarding RNAV (RNP) approach.
- 5.65 - Non-technical change. Changed "must" to "should".
- 5.65 - Non-technical change. Changed "must" to "should".
- 5.66 - Corrected to add non-GLS approach charts.

Go-Around and Missed Approach - All Approaches (FMC U10.6 and earlier)

- 5.80 - Updated the maneuver diagram to match changes to the initiation of Go-Around and Missed Approach procedure.

Go-Around and Missed Approach - All Approaches (FMC 10.7 and later)

- 5.81 - Updated the maneuver diagram to match changes to the initiation of Go-Around and Missed Approach procedure.

Go-Around and Missed Approach - All Engines Operating

5.82 - Added step to "verify that the thrust increases" in accordance with recent recommendations from accident investigation. Added "or flaps as needed". Boeing's intent is to separate the flaps 15 call from the go-around call. This is based on data where 60% of real world go-arounds are initiated at flaps 15 or less.

Chapter 8 - Non-Normal Operations**Engines, APU**

8.15 - Changed "airplane" to "flight path" for clarity and alignment with non-normal situation guidelines.

8.15 - Clarified statement to allow PM to accomplish reference items in NNC as soon as practical.

8.15 - Clarified discussion of engine tailpipe fire. Engine fire warning will not show.

8.16 - Added discussion regarding tailpipe fire awareness.

Evacuation

8.21 - Changed to reference a singular fire bottle for clarity. Aligned with Engine Fire NNC.

8.21 - Changed to reference a singular fire bottle for clarity. Aligned with Engine Fire NNC.

8.21 - Clarified use of engine fire bottle during evacuation.

8.21 - Clarified use of APU fire bottle during evacuation.

Flight Instruments, Displays

8.29 - Updated title to Airspeed Unreliable to align with FCOM NNC.

8.32 - Changed "cross check" to "compare" to align with FCOM NNC.

8.32 - Added recommended guidance for an unreliable airspeed event during takeoff.

8.33 - Non-technical change. Changed title to Airspeed Unreliable for standardization.

8.33 - Non-technical change. Changed to Airspeed Unreliable for standardization.

Landing Gear

8.39 - Corrected title of Landing Gear Lever Will Not Move Up After Takeoff NNC.

8.39 - Non-technical change. Changed "will allow" to "allows".

8.42 - Updated statement for clarity. "...braking on the side with the main gear extended...".

8.43 - Updated statement for clarity. "...braking on the side with the main gear extended...".

Fire

8.48 - Added main deck cargo smoke detection as installed on 737 BCF airplanes.

Windows

8.49 - Added "as installed" to indicate window 3 heat as an option.

Chapter A - Appendices

RNAV Operations

A.2.2 - Non-technical change. Corrected typographical error.

Takeoff Engine Failure

A.2.6 - Non-technical change. Changed "makes" to "make".

UNCONTROLLED
IF PRINTED



Preface

Chapter 0

List of Effective Pages

Section 5

FCTM		
* Title Page 1-2	June 30, 2021	* 1.7 June 30, 2021
Chapter Table of Contents		* 1.8 June 30, 2021
* 0.TOC.1-2	June 30, 2021	* 1.9 June 30, 2021
Model Identification		* 1.10 June 30, 2021
* 0.1.1-2	June 30, 2021	* 1.11 June 30, 2021
Introduction		* 1.12 June 30, 2021
* 0.2.1	June 30, 2021	* 1.13 June 30, 2021
* 0.2.2	June 30, 2021	* 1.14 June 30, 2021
Abbreviations		* 1.15 June 30, 2021
* 0.3.1	June 30, 2021	* 1.16 June 30, 2021
* 0.3.2	June 30, 2021	* 1.17 June 30, 2021
* 0.3.3	June 30, 2021	* 1.18 June 30, 2021
* 0.3.4	June 30, 2021	* 1.19 June 30, 2021
* 0.3.5	June 30, 2021	* 1.20 June 30, 2021
* 0.3.6	June 30, 2021	* 1.21 June 30, 2021
Revision Record		* 1.22 June 30, 2021
* 0.4.1	June 30, 2021	* 1.23 June 30, 2021
* 0.4.2	June 30, 2021	* 1.24 June 30, 2021
Revision Highlights		* 1.25 June 30, 2021
* 0.4.3	June 30, 2021	* 1.26 June 30, 2021
* 0.4.4	June 30, 2021	* 1.27 June 30, 2021
* 0.4.5	June 30, 2021	* 1.28 June 30, 2021
* 0.4.6	June 30, 2021	* 1.29 June 30, 2021
List of Effective Pages		* 1.30 June 30, 2021
* 0.5.1-6	June 30, 2021	* 1.31 June 30, 2021
General Information (tab)		* 1.32 June 30, 2021
* 1.TOC.1-4	June 30, 2021	* 1.33 June 30, 2021
* 1.1	June 30, 2021	* 1.34 June 30, 2021
* 1.2	June 30, 2021	* 1.35 June 30, 2021
* 1.3	June 30, 2021	* 1.36 June 30, 2021
* 1.4	June 30, 2021	* 1.37 June 30, 2021
* 1.5	June 30, 2021	* 1.38 June 30, 2021
* 1.6	June 30, 2021	* 1.39 June 30, 2021
		* 1.40 June 30, 2021
		* 1.41 June 30, 2021
		* 1.42 June 30, 2021
		* 1.43 June 30, 2021
		* 1.44 June 30, 2021
		* 1.45 June 30, 2021
		* 1.46 June 30, 2021
		* 1.47 June 30, 2021
		* 1.48 June 30, 2021
		* 1.49 June 30, 2021
		* 1.50 June 30, 2021

* = Revised, Added, or Deleted

Boeing Proprietary. Copyright © Boeing. May be subject to export restrictions under EAR. See title page for details.

Ground Operations (tab)			
* 2.TOC.1-2	June 30, 2021	* 3.24	June 30, 2021
* 2.1	June 30, 2021	* 3.25	June 30, 2021
* 2.2	June 30, 2021	* 3.26	June 30, 2021
* 2.3	June 30, 2021	* 3.27	June 30, 2021
* 2.4	June 30, 2021	* 3.28	June 30, 2021
* 2.5	June 30, 2021	* 3.29	June 30, 2021
* 2.6	June 30, 2021	* 3.30	June 30, 2021
* 2.7	June 30, 2021	* 3.31	June 30, 2021
* 2.8	June 30, 2021	* 3.32	June 30, 2021
* 2.9	June 30, 2021	* 3.33	June 30, 2021
* 2.10	June 30, 2021	* 3.34	June 30, 2021
* 2.11	June 30, 2021	* 3.35	June 30, 2021
* 2.12	June 30, 2021	* 3.36	June 30, 2021
* 2.13	June 30, 2021	* 3.37	June 30, 2021
* 2.14	June 30, 2021	* 3.38	June 30, 2021
* 2.15	June 30, 2021	* 3.39	June 30, 2021
* 2.16	June 30, 2021	* 3.40	June 30, 2021
* 2.17	June 30, 2021	* 3.41	June 30, 2021
* 2.18	June 30, 2021	* 3.42	June 30, 2021
Takeoff and Initial Climb (tab)		Climb, Cruise, Descent and Holding (tab)	
* 3.TOC.1-2	June 30, 2021	* 4.TOC.1-2	June 30, 2021
* 3.1	June 30, 2021	* 4.1	June 30, 2021
* 3.2	June 30, 2021	* 4.2	June 30, 2021
* 3.3	June 30, 2021	* 4.3	June 30, 2021
* 3.4	June 30, 2021	* 4.4	June 30, 2021
* 3.5	June 30, 2021	* 4.5	June 30, 2021
* 3.6	June 30, 2021	* 4.6	June 30, 2021
* 3.7	June 30, 2021	* 4.7	June 30, 2021
* 3.8	June 30, 2021	* 4.8	June 30, 2021
* 3.9	June 30, 2021	* 4.9	June 30, 2021
* 3.10	June 30, 2021	* 4.10	June 30, 2021
* 3.11	June 30, 2021	* 4.11	June 30, 2021
* 3.12	June 30, 2021	* 4.12	June 30, 2021
* 3.13	June 30, 2021	* 4.13	June 30, 2021
* 3.14	June 30, 2021	* 4.14	June 30, 2021
* 3.15	June 30, 2021	* 4.15	June 30, 2021
* 3.16	June 30, 2021	* 4.16	June 30, 2021
* 3.17	June 30, 2021	* 4.17	June 30, 2021
* 3.18	June 30, 2021	* 4.18	June 30, 2021
* 3.19	June 30, 2021	* 4.19	June 30, 2021
* 3.20	June 30, 2021	* 4.20	June 30, 2021
* 3.21	June 30, 2021	* 4.21	June 30, 2021
* 3.22	June 30, 2021	* 4.22	June 30, 2021
* 3.23	June 30, 2021	* 4.23	June 30, 2021
		* 4.24	June 30, 2021

* = Revised, Added, or Deleted

Boeing Proprietary. Copyright © Boeing. May be subject to export restrictions under EAR. See title page for details.



737 NG Flight Crew Training Manual

Approach and Missed Approach (tab)			
* 5.TOC.1-4	June 30, 2021	* 5.45	June 30, 2021
* 5.1	June 30, 2021	* 5.46	June 30, 2021
* 5.2	June 30, 2021	* 5.47	June 30, 2021
* 5.3	June 30, 2021	* 5.48	June 30, 2021
* 5.4	June 30, 2021	* 5.49	June 30, 2021
* 5.5	June 30, 2021	* 5.50	June 30, 2021
* 5.6	June 30, 2021	* 5.51	June 30, 2021
* 5.7	June 30, 2021	* 5.52	June 30, 2021
* 5.8	June 30, 2021	* 5.53	June 30, 2021
* 5.9	June 30, 2021	* 5.54	June 30, 2021
* 5.10	June 30, 2021	* 5.55	June 30, 2021
* 5.11	June 30, 2021	* 5.56	June 30, 2021
* 5.12	June 30, 2021	* 5.57	June 30, 2021
* 5.13	June 30, 2021	* 5.58	June 30, 2021
* 5.14	June 30, 2021	* 5.59	June 30, 2021
* 5.15	June 30, 2021	* 5.60	June 30, 2021
* 5.16	June 30, 2021	* 5.61	June 30, 2021
* 5.17	June 30, 2021	* 5.62	June 30, 2021
* 5.18	June 30, 2021	* 5.63	June 30, 2021
* 5.19	June 30, 2021	* 5.64	June 30, 2021
* 5.20	June 30, 2021	* 5.65	June 30, 2021
* 5.21	June 30, 2021	* 5.66	June 30, 2021
* 5.22	June 30, 2021	* 5.67	June 30, 2021
* 5.23	June 30, 2021	* 5.68	June 30, 2021
* 5.24	June 30, 2021	* 5.69	June 30, 2021
* 5.25	June 30, 2021	* 5.70	June 30, 2021
* 5.26	June 30, 2021	* 5.71	June 30, 2021
* 5.27	June 30, 2021	* 5.72	June 30, 2021
* 5.28	June 30, 2021	* 5.73	June 30, 2021
* 5.29	June 30, 2021	* 5.74	June 30, 2021
* 5.30	June 30, 2021	* 5.75	June 30, 2021
* 5.31	June 30, 2021	* 5.76	June 30, 2021
* 5.32	June 30, 2021	* 5.77	June 30, 2021
* 5.33	June 30, 2021	* 5.78	June 30, 2021
* 5.34	June 30, 2021	* 5.79	June 30, 2021
* 5.35	June 30, 2021	* 5.80	June 30, 2021
* 5.36	June 30, 2021	* 5.81	June 30, 2021
* 5.37	June 30, 2021	* 5.82	June 30, 2021
* 5.38	June 30, 2021	* 5.83	June 30, 2021
* 5.39	June 30, 2021	* 5.84	June 30, 2021
* 5.40	June 30, 2021	* 5.85	June 30, 2021
* 5.41	June 30, 2021	* 5.86	June 30, 2021
* 5.42	June 30, 2021		
* 5.43	June 30, 2021		
* 5.44	June 30, 2021		
		Landing (tab)	
		* 6.TOC.1-2	June 30, 2021
		* 6.1	June 30, 2021
		* 6.2	June 30, 2021

* = Revised, Added, or Deleted

Boeing Proprietary. Copyright © Boeing. May be subject to export restrictions under EAR. See title page for details.

* 6.3	June 30, 2021	* 6.50	June 30, 2021
* 6.4	June 30, 2021	* 6.51	June 30, 2021
* 6.5	June 30, 2021	* 6.52	June 30, 2021
* 6.6	June 30, 2021	Maneuvers (tab)	
* 6.7	June 30, 2021	* 7.TOC.1-2	June 30, 2021
* 6.8	June 30, 2021	* 7.1	June 30, 2021
* 6.9	June 30, 2021	* 7.2	June 30, 2021
* 6.10	June 30, 2021	* 7.3	June 30, 2021
* 6.11	June 30, 2021	* 7.4	June 30, 2021
* 6.12	June 30, 2021	* 7.5	June 30, 2021
* 6.13	June 30, 2021	* 7.6	June 30, 2021
* 6.14	June 30, 2021	* 7.7	June 30, 2021
* 6.15	June 30, 2021	* 7.8	June 30, 2021
* 6.16	June 30, 2021	* 7.9	June 30, 2021
* 6.17	June 30, 2021	* 7.10	June 30, 2021
* 6.18	June 30, 2021	* 7.11	June 30, 2021
* 6.19	June 30, 2021	* 7.12	June 30, 2021
* 6.20	June 30, 2021	* 7.13	June 30, 2021
* 6.21	June 30, 2021	* 7.14	June 30, 2021
* 6.22	June 30, 2021	* 7.15	June 30, 2021
* 6.23	June 30, 2021	* 7.16	June 30, 2021
* 6.24	June 30, 2021	* 7.17	June 30, 2021
* 6.25	June 30, 2021	* 7.18	June 30, 2021
* 6.26	June 30, 2021	* 7.19	June 30, 2021
* 6.27	June 30, 2021	* 7.20	June 30, 2021
* 6.28	June 30, 2021	* 7.21	June 30, 2021
* 6.29	June 30, 2021	* 7.22	June 30, 2021
* 6.30	June 30, 2021	* 7.23	June 30, 2021
* 6.31	June 30, 2021	* 7.24	June 30, 2021
* 6.32	June 30, 2021	* 7.25	June 30, 2021
* 6.33	June 30, 2021	* 7.26	June 30, 2021
* 6.34	June 30, 2021	* 7.27	June 30, 2021
* 6.35	June 30, 2021	* 7.28	June 30, 2021
* 6.36	June 30, 2021	Non-Normal Operations (tab)	
* 6.37	June 30, 2021	* 8.TOC.1-4	June 30, 2021
* 6.38	June 30, 2021	* 8.1	June 30, 2021
* 6.39	June 30, 2021	* 8.2	June 30, 2021
* 6.40	June 30, 2021	* 8.3	June 30, 2021
* 6.41	June 30, 2021	* 8.4	June 30, 2021
* 6.42	June 30, 2021	* 8.5	June 30, 2021
* 6.43	June 30, 2021	* 8.6	June 30, 2021
* 6.44	June 30, 2021	* 8.7	June 30, 2021
* 6.45	June 30, 2021	* 8.8	June 30, 2021
* 6.46	June 30, 2021	* 8.9	June 30, 2021
* 6.47	June 30, 2021	* 8.10	June 30, 2021
* 6.48	June 30, 2021		
* 6.49	June 30, 2021		

* = Revised, Added, or Deleted

Boeing Proprietary. Copyright © Boeing. May be subject to export restrictions under EAR. See title page for details.



737 NG Flight Crew Training Manual

* 8.11	June 30, 2021	
* 8.12	June 30, 2021	
* 8.13	June 30, 2021	
* 8.14	June 30, 2021	
* 8.15	June 30, 2021	
* 8.16	June 30, 2021	
* 8.17	June 30, 2021	
* 8.18	June 30, 2021	
* 8.19	June 30, 2021	
* 8.20	June 30, 2021	
* 8.21	June 30, 2021	
* 8.22	June 30, 2021	
* 8.23	June 30, 2021	
* 8.24	June 30, 2021	
* 8.25	June 30, 2021	
* 8.26	June 30, 2021	
* 8.27	June 30, 2021	
* 8.28	June 30, 2021	
* 8.29	June 30, 2021	
* 8.30	June 30, 2021	
* 8.31	June 30, 2021	
* 8.32	June 30, 2021	
* 8.33	June 30, 2021	
* 8.34	June 30, 2021	
* 8.35	June 30, 2021	
* 8.36	June 30, 2021	
* 8.37	June 30, 2021	
* 8.38	June 30, 2021	
* 8.39	June 30, 2021	
* 8.40	June 30, 2021	
* 8.41	June 30, 2021	
* 8.42	June 30, 2021	
* 8.43	June 30, 2021	
* 8.44	June 30, 2021	
* 8.45	June 30, 2021	
* 8.46	June 30, 2021	
* 8.47	June 30, 2021	
* 8.48	June 30, 2021	
* 8.49	June 30, 2021	
* 8.50	June 30, 2021	
* 8.51	June 30, 2021	
* 8.52	June 30, 2021	
* 8.53	June 30, 2021	
* 8.54	June 30, 2021	
		Appendices - Operational Information (tab)
* A.1.1	June 30, 2021	
* A.1.2	June 30, 2021	
		Appendices- Supplemental Information
* A.2.1	June 30, 2021	
* A.2.2	June 30, 2021	
* A.2.3	June 30, 2021	
* A.2.4	June 30, 2021	
* A.2.5	June 30, 2021	
* A.2.6	June 30, 2021	
* A.2.7	June 30, 2021	
* A.2.8	June 30, 2021	
* A.2.9	June 30, 2021	
* A.2.10	June 30, 2021	
* A.2.11	June 30, 2021	
* A.2.12	June 30, 2021	
		Index
* Index.1-10	June 30, 2021	
		(blank tab)

* = Revised, Added, or Deleted

Boeing Proprietary. Copyright © Boeing. May be subject to export restrictions under EAR. See title page for details.

Intentionally
Blank

UNCONTROLLED
IF PRINTED

* = Revised, Added, or Deleted

Boeing Proprietary. Copyright © Boeing. May be subject to export restrictions under EAR. See title page for details.



General Information

Chapter 1

Table of Contents

Section TOC

Preface 1.1

Flight Deck Philosophy 1.1

 Key Elements of Flight Deck Design 1.2

Operational Philosophy 1.4

 Events Requiring Maintenance Inspection 1.4

Training Objectives 1.5

Qualification Requirements (Checkride) 1.5

 Evaluation 1.5

Crew Resource Management 1.5

Headphone and Flight Deck Speaker Use 1.6

Display Panel Management 1.6

Maneuver Speeds and Margins 1.6

 Flap Maneuver Speeds 1.6

 Minimum Maneuver Speed 1.7

 Maneuver Margins to Stick Shaker 1.10

Command Speed 1.14

 Takeoff 1.14

 Climb, Cruise and Descent 1.14

 Approach 1.14

 Landing 1.14

 Non-Normal Conditions 1.15

Reference Bugs 1.16

 Bug Setting (MASI or PFD/ND) 1.16

Thrust Management 1.17

 Setting Thrust 1.17

Boeing Proprietary. Copyright © Boeing. May be subject to export restrictions under EAR. See title page for details.

Maximum Thrust	1.18
Callouts	1.19
Recommended Callouts	1.20
Standard Phraseology	1.23
Electronic Flight Bag	1.24
Airport Moving Map	1.24
Terminal Charts	1.25
Airplane Performance	1.25
Video Surveillance.	1.25
Electronic Logbook and Other Documents	1.25
Flight Path Vector.	1.26
Vertical Situation Display	1.27
Cold Temperature Altitude Corrections.	1.28
Operation in Icing Conditions	1.28
Ice Crystal Icing.	1.29
Training Flights	1.30
Recommended Rudder Trim Technique	1.30
Drag Factors Due to Trim Technique	1.30
Primary Rudder Trim Technique.	1.30
Alternate Rudder Trim Technique.	1.31
Flight Management Computer(s)/CDUs.	1.32
FMC Route Verification Techniques.	1.32
FMC Performance Predictions.	1.33
RNAV Operations.	1.33
RNP and ANP Definitions.	1.34
Basic RNP Concept	1.36
GPS Use in Non-WGS-84 Reference Datum Airspace	1.40

737 NG Flight Crew Training Manual

Weather Radar and Terrain Display Policy	1.40
AFDS Guidelines	1.40
Autothrottle Use	1.41
Manual Flight	1.41
Automatic Flight	1.42
MCP Altitude Setting Techniques Using VNAV	1.43
AFDS Mode Control Panel Faults	1.45
Head Up Display	1.46
Pilot Incapacitation	1.47
Crew Action Upon Confirming Pilot Incapacitation	1.48
Moderate to Heavy Rain, Hail, or Sleet	1.48
Turbulent Air Penetration	1.49

Intentionally
Blank

UNCONTROLLED
IF PRINTED



Preface

This chapter outlines the Boeing flight deck design philosophy and operational policies used during training. Recommended procedures for Crew Coordination, Flap/Speed Schedule, Thrust Management, Turbulent Air Penetration, and Crew Resource Management are covered. This provides a basis for standardization. Conditions beyond the control of the flight crew may preclude following a maneuver exactly. The maneuvers are not intended to replace good judgment and logic.

Flight Deck Philosophy

The Boeing flight deck has changed significantly over the years with increased systems integration, automation and complexity. The flight training and flight manuals align with the Boeing flight deck design philosophy. An understanding of the design philosophies of the modern Boeing flight deck should reinforce the flight training and help flight crews deal with circumstances that may not be specifically covered in the operational flight manuals.

UNCONTINUED
IF PRINTED

Key Elements of Flight Deck Design

- All displays and controls required for flight are designed to be viewable and reachable by both pilots or duplicated at each crew station and perform satisfactorily under all lighting conditions.
- Quiet or dark flight deck during normal operations. There are minimal indications of normal status.
- Alerts are categorized into time-critical warnings, warnings and cautions, and are prioritized by the urgency of required pilot response.
 - Time critical warnings are non-normal operational or system condition requiring immediate crew awareness and corrective action to maintain safe flight
 - Warnings alert the crew to a non-normal operational or system condition requiring immediate crew awareness and corrective action
 - Cautions alert the crew to a non-normal operational or system condition that require the possible need for future corrective action.
- Colors are consistent with industry standards and requirements. In general the colors used on the Boeing flight deck are:
 - Red is the highest priority safety-related information. Warning level alerts are displayed in red and require immediate awareness and corrective action. Red is also used for keep-out zones and do-not-exceed limits.
 - Amber is the second priority safety-related information. Caution level alerts are displayed in amber and require immediate crew awareness and subsequent response. Advisory level alerts are displayed in amber text. Amber is also used for flags, non-normal sources, and regions of limited operation.
 - Green is used to indicate active, engaged, selected and tuned. Green is also used to indicate fly-to areas.
 - White is used for real-time information, scales and values that are ready to be used
 - Magenta is used for target values and the FMC-generated flight path

737 NG Flight Crew Training Manual

- Cyan is used for inactive data, labels and background.
- Blue is used for informational purposes.
- Linked and back-driven flight controls will reflect how the other pilot or the autoflight system is commanding the airplane. This control motion is an effective means of attracting attention to control input to aid situational awareness and enable a smooth transition, or handoff, between pilots and automation.
- Linked pilot controls, including fly-by-wire systems, provide conventional control wheel input and indications. Both pilot controls are mechanically linked and provide tactile and visual cues to how the pilot flying is controlling input to the airplane.
- The autoflight system will back-drive the control wheel and thrust levers. When the autopilot system is engaged the control wheel is back-driven to indicate what the autopilot system is commanding to the flight controls. The autothrottle system will back-drive the thrust levers according to what the autothrottle system is commanding. Pilot input can override the autopilot and autothrottle commands.

Pilot Responsibilities

Boeing flight decks are designed to support the priorities of aviate, navigate, communicate and manage airplane systems.

The Captain is ultimately responsible for the safe operation of the airplane. Both flight crew members are responsible for the safe conduct of the flight. Automation assists the flight crew in the efficient operation of the airplane. If the airplane is not performing as needed, or expected, the flight crew must assume positive control of the airplane.

The flight deck design assumes the pilot will:

- Respond correctly and safely to alert conditions.
- Prioritize warnings over cautions.
- Maintain situational awareness at all times. Both pilots should check the flight instruments and flight mode annunciations and verify that the airplane is responding appropriately. Both pilots need to anticipate what needs to be done next and how the airplane should respond.
- Use the appropriate level of automation for the situation. Hand off a task to automation in the state needed. Engage automation when the workload increases and take over manual control of the airplane when needed.
- Apply critical thinking and judgment. If indications are not as expected seek verifying information and take appropriate action.

Operational Philosophy

The procedures and checklists are designed for use by trained flight crewmembers. The procedure sequence follows a definitive panel scan pattern. Each crewmember is assigned a flight deck area to initiate action in accordance with Normal and Supplementary Procedures. Non-normal procedural actions and actions outside the crewmembers' area of responsibility are initiated at the direction of the captain.

Non-normal checklists are provided to cope with or resolve non-normal situations on the ground or in flight.

Supplementary Procedures are accomplished as required rather than on each flight sector or segment. Supplementary Procedures are found in the FCOM Volume 1.

Events Requiring Maintenance Inspection

Appendix A.2.1

During ground or flight operations, events may occur which require a maintenance inspection after the flight. Use the following guidance to determine which events require a maintenance inspection:

- hard landing - specify if the landing was hard on the nose gear only, hard on the main gear only or hard on both main and nose gear. Specify if the landing was a hard bounced landing

Note: A bounced landing is defined as a landing where both main gears contact the ground and then both main gears leave the ground prior to landing.

Note: A nose first landing is considered to be a hard nose gear landing.

- overweight landing - if the overweight landing was not a hard landing the flight crew should record that the landing was not a hard landing
- high drag/high side load event - one or more of the following conditions occurred:
 - airplane ran off the prepared surface
 - airplane landed short of prepared surface
 - two or more tires were blown during landing
 - one or more landing gear hit an obstacle or were hit by an obstacle
 - airplane landed with a large crab or high bank angle resulting in abnormally large side-to-side forces as the airplane aligns with the runway after touchdown.
- severe turbulence
- overspeed - flap/slat, MMO/VMO, landing gear, landing gear tires
- high-energy stop (refer to the AMM for guidance)
- lightning strike
- extreme dust

737 NG Flight Crew Training Manual

- tail strike
- any event that the pilot feels a maintenance inspection could be needed. An example of such an event is an overly aggressive pitch up during a TCAS event or a Terrain Avoidance maneuver that could cause structural damage.
- operator-specific procedures or policies may include additional events that require a maintenance inspection.

Note: If in doubt, the best course of action is to report it.

Training Objectives

The flight-training program prepares the student for airplane qualification and/or the FAA Type Rating checkride (or equivalent). Flight safety, passenger comfort and operational efficiency are emphasized.

Qualification Requirements (Checkride)

Following satisfactory completion of training and when recommended by an authorized instructor, each pilot must satisfactorily demonstrate the ability to perform maneuvers and procedures prescribed in FAA or other applicable governing regulations. Throughout the prescribed maneuvers, command ability and good judgment commensurate with a high level of safety must be demonstrated. In determining whether such judgment has been shown, the evaluator considers adherence to approved procedures, actions based on the analysis of situations, and care and prudence in selecting the course of action.

Evaluation

An evaluation may be given at the end of simulator training. The content of the evaluation varies with the capabilities of the simulator used and the requirements of the governing regulatory agency.

An evaluation in the airplane may be required if the training has not been accomplished under the prescribed requirements of FAA or other applicable governing regulations.

Crew Resource Management

Crew resource management is the application of team management concepts and the effective use of all available resources to operate a flight safely. In addition to the aircrew, it includes all other groups routinely working with the aircrew who are involved in decisions required to operate a flight. These groups include, but are not limited to, airplane dispatchers, cabin crew, maintenance personnel, and air traffic controllers.

Throughout this manual, techniques that help build good CRM habit patterns on the flight deck are discussed. For example, situational awareness and communications are stressed. Situational awareness, or the ability to accurately perceive what is going on in the flight deck and outside the airplane, requires ongoing monitoring, questioning, crosschecking, communication, and refinement of perception.

It is important that all flight deck crewmembers identify and communicate any situation that appears unsafe or out of the ordinary. Experience has proven that the most effective way to maintain safety of flight and resolve these situations is to combine the skills and experience of all crewmembers in the decision making process to determine the safest course of action.

Headphone and Flight Deck Speaker Use

Boeing recommends that crews wear headphones or boom microphones/headsets during takeoff until the top of climb, and from the start of descent throughout approach and landing. During cruise, flight deck speakers may be used. Speaker volume should be kept at the minimum usable level adequate to avoid interference with normal crew flight deck conversation, but still ensure reception of relevant communications.

Display Panel Management

Unless specifically directed in a procedure, Boeing does not recommend what displays the crew should be monitoring during ground or in-flight operations. The flight crew is encouraged to select a display during any phase of flight that they feel is the most efficient way to get desired information.

Maneuver Speeds and Margins

This section explains the difference between flap maneuver speeds and minimum maneuver speeds. It also describes maneuver margin or bank capability to stick shaker as a function of airspeed during both a flap extension and flap retraction scenario.

Flap Maneuver Speeds

The following tables contain flap maneuver speeds for various flap settings. The flap maneuver speed is the recommended operating speed during takeoff or landing operations. These speeds guarantee full maneuver capability or at least 40° of bank (25° of bank and 15° overshoot) to stick shaker within a few thousand feet of the airport altitude. While the flaps may be extended up to 20,000 feet, less maneuver margin to stick shaker exists for a fixed speed as altitude increases.

737 NG Flight Crew Training Manual

Flap Position	All Weights
Flaps UP	VREF 40 + 70
Flaps 1	VREF 40 + 50
Flaps 5	VREF 40 + 30
Flaps 10	VREF 40 + 30
Flaps 15	VREF 40 + 20
Flaps 25	VREF 40 + 10
Flaps 30	VREF 30
Flaps 40	VREF 40

Minimum Maneuver Speed

The top of the lower amber band on the airspeed display indicates the minimum maneuver speed. The functionality of the lower amber band is slightly different for flaps-down versus flaps-up operation; however, in both cases it alerts the crew that when operating at an airspeed within the amber band less than full maneuver capability exists.

Note: During normal conditions, the target speed is always equal to or faster than the minimum maneuver speed (top of the amber band). During non-normal conditions, the target speed may be below the minimum maneuver speed.

Flaps Down Amber Band

For all flaps-down operations (any time the flaps are not full-up) the minimum maneuver speed is the slowest speed that provides full maneuver capability, 1.3g or 40° of bank (25° of bank and 15° overshoot), to stick shaker. The top of the amber band does not vary with g load.

As airspeed is decreased below the top of the amber band, maneuver capability decreases. In 1g flight, the speed in the middle of the amber band provides adequate maneuver capability or 30° of bank (15° of bank and 15° overshoot). The speed at the bottom of the amber band (top of the red and black tape) corresponds to stick shaker activation for the current g load. If the g load is increased during maneuvering, the stick shaker activation speed increases also.

Note: Stick shaker is set to activate before the actual stall. There is sufficient margin to recover from stick shaker without stalling.

The following diagram shows airspeed location relative to the amber band for airplanes equipped with MASI or PFD.

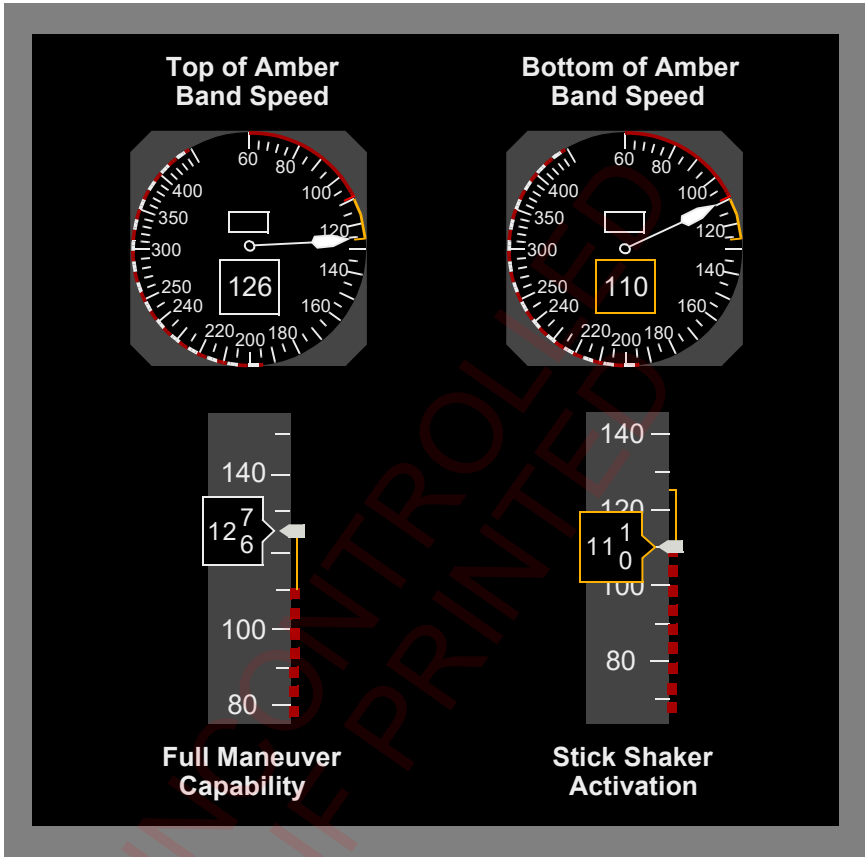

Minimum maneuver speeds (displayed as the top of the lower amber band) should not be confused with flap maneuver speeds. Flap maneuver speeds are based on airplane weight, while the minimum maneuver speed is calculated using airplane angle of attack and current airspeed. These speeds provide independent means to ensure that the current airspeed provides at least full maneuver capability for terminal-area maneuvering.

Note: During normal conditions, the flap maneuver speed for the current flap detent should always be equal to or faster than the minimum maneuver speed. During some non-normal conditions, the flap maneuver speed for the current flap position may be less than the minimum maneuver speed.

737 NG Flight Crew Training Manual

Flaps Up Amber Band

For altitudes up to approximately 10,000 feet, the flaps-up amber band functions just like the flaps-down amber band described above, with the top of the amber band representing full maneuver capability. Due to increasing Mach effects between 10,000 and 20,000 feet, the maneuver capability at the top of the amber band decreases as altitude increases, but still provides at least adequate maneuver capability. Above approximately 20,000 feet, the top of the amber band shows the speed that provides 1.3g maneuver capability to low speed buffet (or an alternative approved maneuver capability as preset by maintenance).

UNCONTROLLED
IF PRINTED

Maneuver Margins to Stick Shaker

The following figures are representative illustrations of airplane maneuver margin or bank capability to stick shaker as a function of airspeed. This includes both a flap extension and flap retraction scenario. These charts are generalized to show relative trends of maneuver capability during flap retraction and extension and are not meant to be representative of any one takeoff or landing condition.

When reviewing the maneuver margin illustrations, note that:

- there is a direct correlation between bank angle and load factor (gs) in level, constant speed flight. For example, 1.1g corresponds to 25° of bank, 1.3g ~ 40°, 2.0g ~ 60°
- the illustrated maneuver margin assumes a constant speed, level flight condition
- stick shaker activates prior to actual stall speed
- flap retraction or extension speed is that speed where the flaps are moved to the next flap position in accordance with the flap retraction or extension schedule
- flap retraction and extension schedules provide speeds that are close to minimum drag, and in a climb are close to maximum angle of climb speed. In level flight they provide a relatively constant pitch attitude and require little change in thrust at different flap settings.
- the bold line designates flap configuration changes at the scheduled flap retraction or extension speeds
- the black dots on the bold lines indicate:
 - maneuver speed for the existing flap setting
 - flap retraction or extension speed for the next flap setting
- maneuver margins are based on basic stick shaker schedules and do not include adjustments for the use of anti-ice.

The distance between the bold line representing the flap extension or retraction schedule and a given bank angle represents the maneuver margin to stick shaker at the given bank angle for level constant speed flight. Where the flap extension or retraction schedule extends below a depicted bank angle, stick shaker activation can be expected prior to reaching that bank angle.

Conditions Affecting Maneuver Margins to Stick Shaker

For a fixed weight and altitude, maneuver margin to stick shaker increases when airspeed increases. Other factors may or may not affect maneuver margin:

- Gross weight: generally maneuver margin decreases as gross weight increases. The base speed (V₂ or V_{REF}) increases with increasing weight. The speed additive is a smaller percent increase for heavier weights
- Altitude: generally maneuver margin decreases with increasing altitude for a fixed airspeed

737 NG Flight Crew Training Manual

- Temperature: the affect of a temperature change on maneuver margin is negligible
- Landing gear: a small decrease in maneuver margin may occur when the landing gear is extended. This loss is equivalent to 2 knots of airspeed or less
- Speedbrakes: maneuver margin decreases at any flap setting when speedbrakes are extended
- Engine failure during flap retraction: a small decrease in maneuver margin occurs due to the reduced lift experienced with the loss of thrust. The loss is equivalent to 4 knots of airspeed or less
- Anti-ice: the use of wing anti-ice reduces the flaps-up and flaps-down maneuver margin. The use of engine anti-ice reduces the flaps-down maneuver margin but has no affect on the flaps-up maneuver margin. If only the engine anti-ice is used, the effect goes away when the engine anti-ice is turned off. If the wing anti-ice is used, the effect remains until the airplane lands

Note: The term “reduced maneuver margin”, when used in reference to anti-ice systems, means that the stall warning logic adjusts stick shaker to a lower angle of attack. This results in a higher stick shaker speed and a higher minimum maneuver speed. Flap retraction and extension speeds are not affected by the use of anti-ice systems, therefore maneuver margin is reduced.

UNCONTROLLED
IF PRINTED

Maneuver Margins to Stick Shaker- Flap Retraction

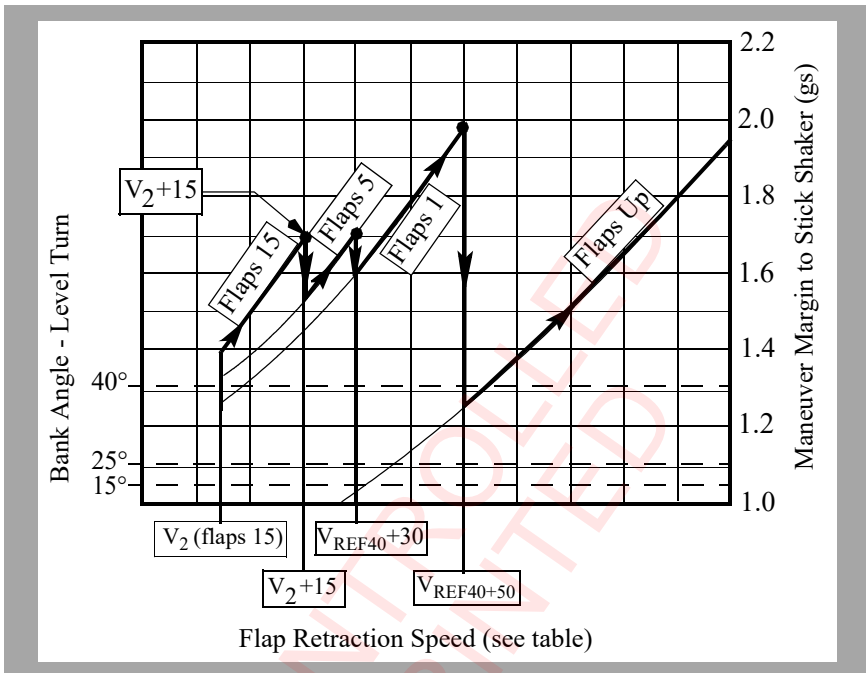

Takeoff Flaps	At Speed (display)	Flap Retraction Speed	Select Flaps
25	$V_2 + 15$	$V_2 + 15$	15
	"15"	$V_{ref} 40 + 20$	5
	"5"	$V_{ref} 40 + 30$	1
	"1"	$V_{ref} 40 + 50$	UP
15 or 10	$V_2 + 15$	$V_2 + 15$	5
	"5"	$V_{ref} 40 + 30$	1
	"1"	$V_{ref} 40 + 50$	UP
5	$V_2 + 15$	$V_2 + 15$	1
	"1"	$V_{ref} 40 + 50$	UP
1	"1"	$V_{ref} 40 + 50$	UP

- "UP" - Flaps up maneuver speed.
- "1", "5", "15" - Number corresponding to flap maneuver speed.

Limit bank angle to 15° until reaching $V_2 + 15$ knots.

737 NG Flight Crew Training Manual

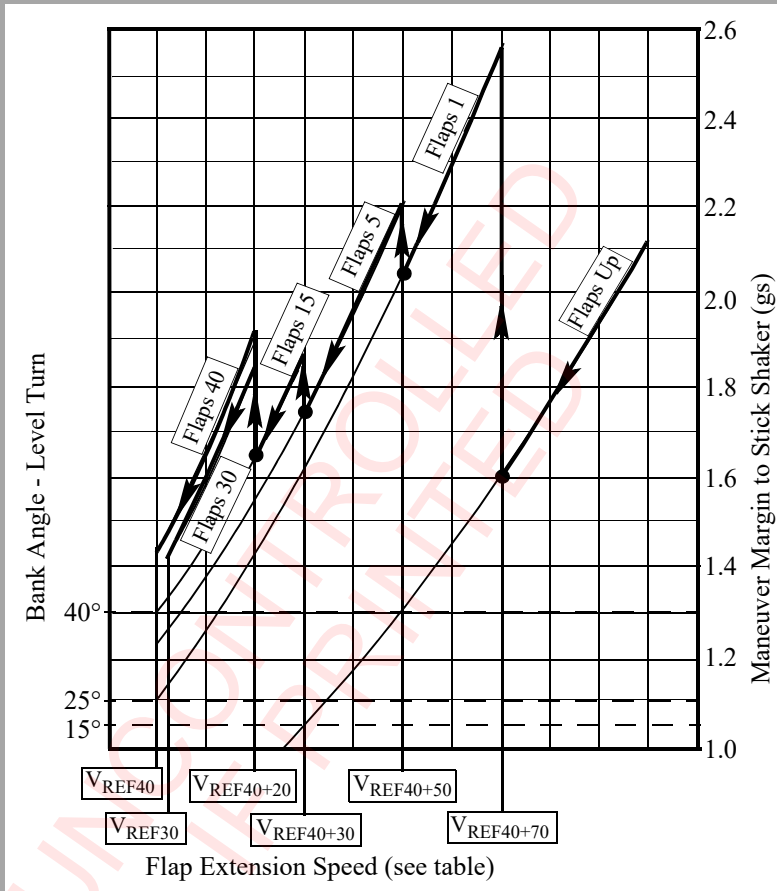
Maneuver Margins to Stick Shaker - Flap Extension

Current Flap Position	At Speed tape "Display"	Flap Extension Speed	Select Flaps	Command Speed for Selected Flaps
UP	"UP"	Vref 40 + 70	1	"1"
1	"1"	Vref 40 + 50	5	"5"
5	"5"	Vref 40 + 30	15	"15"
15	"15"	Vref 40 + 20	30 or 40	(Vref 30 or Vref 40) plus wind additives

Command Speed

Command speed may be set by the pilot through the MCP or FMC and is displayed by a magenta airspeed cursor on the airspeed indicator or by a magenta speed bug on the PFD airspeed display.

Takeoff

Command speed remains set at V_2 until changed by the pilot for acceleration and flap retraction or until a subsequent pitch mode is engaged. Manually select flaps up maneuver speed at acceleration height.

Climb, Cruise and Descent

Command speed is set to the appropriate speed by the FMC during VNAV operation or manually using the MCP.

Approach

Command speed is set to the maneuver speed for the selected flap position by the FMC during VNAV operation or manually using the MCP.

Landing

When using the autothrottle, position command speed to $V_{REF} + 5$ knots. Sufficient wind and gust protection is available with the autothrottle connected because the autothrottle is designed to adjust thrust rapidly when the airspeed drops below command speed while reducing thrust slowly when the airspeed exceeds command speed. In turbulence, the result is that average thrust is higher than necessary to maintain command speed. This results in an average speed exceeding command speed.

If the autothrottle is disconnected, or is planned to be disconnected prior to landing, the recommended method for approach speed correction is to add one half of the reported steady headwind component plus the full gust increment above the steady wind to the reference speed. The minimum command speed setting is $V_{REF} + 5$ knots. One half of the reported steady headwind component can be estimated by using 50% for a direct headwind, 35% for a 45° crosswind, zero for a direct crosswind and interpolation in between.

When making adjustments for winds, the maximum approach speed should not exceed $V_{REF} + 15$ knots or landing flap placard speed minus 5 knots, whichever is lower. This technique provides sufficient low speed maneuver capability and reduces the possibility of flap load relief activation. Margin to load relief activation may also be increased by using a reduced landing flap setting. The following table shows examples of wind additives with a runway heading of 360° .

737 NG Flight Crew Training Manual

Reported Winds	Wind Additive	Approach Speed
360 at 16	8	VREF + 8 knots
Calm	0	VREF + 5 knots
360 at 20 Gust to 30	10 + 10	VREF + 15 knots*
060 at 24	6	VREF + 6 knots
090 at 15	0	VREF + 5 knots
090 at 15 Gust to 25	0 + 10	VREF + 10 knots
120 at 10 Gust to 20	0	VREF + 5 knots
135 at 10	0	VREF + 5 knots

* If VREF + 15 knots exceeds landing flap placard speed minus 5 knots, use landing flap placard speed minus 5 knots.

Note: Do not apply wind additives for steady tailwinds or tailwind gusts. Set command speed at VREF + 5 knots (autothrottle connected or disconnected).

Non-Normal Conditions

Occasionally, a non-normal checklist instructs the flight crew to use a VREF speed that also includes a speed additive such as VREF 15 + 15 knots. When VREF has been adjusted by a NNC, this becomes the VREF used for landing. This VREF does not include wind additives. For example, if a non-normal checklist specifies “Use flaps 15 and VREF 15 + 10 knots for landing”, the flight crew would select flaps 15 as the landing flaps and look up the VREF 15 speed in the FMC or QRH and add 10 knots to that speed.

When using the autothrottle, position command speed to VREF + 5 knots. Sufficient wind and gust protection is available with the autothrottle connected that no further wind additives are needed.

If the autothrottle is disconnected, or is planned to be disconnected prior to landing, appropriate wind additives must be added to the VREF to arrive at command speed, the speed used to fly the approach. For example, if the checklist states “use VREF 40 + 30 knots”, command speed should be positioned to VREF (VREF 40 + 30 knots) plus wind additive (5 knots minimum, 15 knots maximum).

If a flaps 15 landing is performed and VREF ICE is required, (VREF ICE = VREF 15 + 10 knots), the wind additives should not exceed 5 knots.

Reference Bugs

The following figure shows the positioning of the reference bugs on the airspeed indicator for takeoff and approach.

Bug Setting (MASI or PFD/ND)

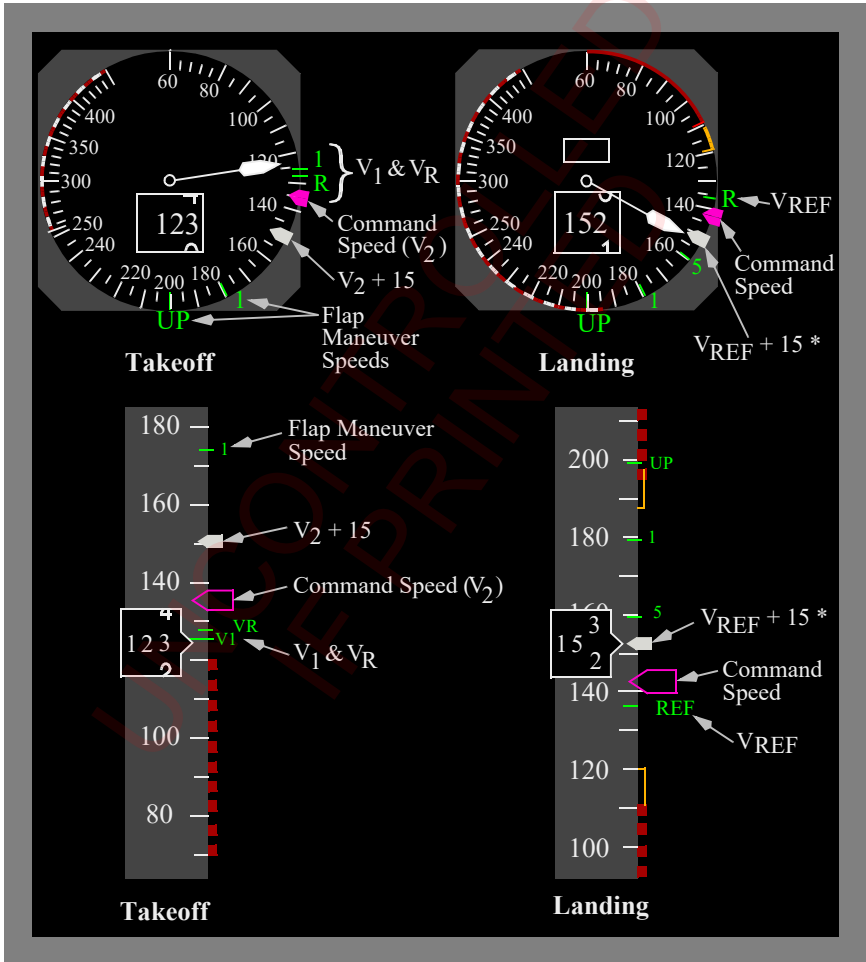

737-800 - 737-900ER

* VREF + 20 knots with CDS Block Point 2004 and later. Refer to the FCOM for correct configuration.

737 NG Flight Crew Training Manual

Takeoff

After zero fuel weight, V1, and VR are entered into the FMC, airspeed bugs are automatically displayed at V1, VR and the minimum flap retraction speed for the next flap position. Command speed is set at V2 using the MCP. V2 is the minimum takeoff safety speed and provides at least 30° bank capability (15° + 15° overshoot) for all takeoff flaps. An airspeed bug is automatically set 15 knots above command speed. V2 + 15 knots provides 40° bank capability (25° + 15° overshoot) for all takeoff flaps.

Approach - Landing

737-600, 737-700

VREF and VREF + 15 knots are displayed upon entry of landing flaps/speed in the FMC. The maneuver speed for the current flap position and the next flap position are automatically displayed on the airspeed display.

737-800 - 737-900ER

VREF and VREF + 15 knots (VREF + 20 knots for airplanes with CDS Block Point 2004 and later) are displayed upon entry of landing flaps/speed in the FMC. The maneuver speed for the current flap position and the next flap position are automatically displayed on the airspeed display.

Bug Setting with FMC Inoperative

With FMC inoperative, the speed reference selector is used to set V1, VR and VREF. Refer to the FCOM, Section SP.10, for details.

Thrust Management**Setting Thrust**

The term “set thrust” or “verify that thrust is set” is used in various places in the FCTM and the FCOM. The proper thrust setting is determined by the N1 indication. However, when setting or verifying that the proper thrust is set, the flight crew's attention should not be focused on setting the exact indication at the expense of crosschecking that other engine indications are consistent with the N1 indication and maintaining situational awareness.

Maximum Thrust

The term “maximum thrust” is used in various places in the FCTM and the FCOM. Maximum thrust is attained:

- for airplanes with electronic engine controls (EECs) operating in the normal mode, by advancing the thrust levers full forward
- for airplanes with EECs operating in the alternate mode, by advancing the thrust levers to the full rated takeoff or go-around limit only. Advancing the thrust levers to the full forward stop should only be considered if terrain contact is imminent.

Note: This definition of maximum thrust applies to all situations except when a fixed derate takeoff is accomplished. The fixed derate is considered a limitation for takeoff. Further explanation of thrust limitations during a fixed derate takeoff are found in the Reduced Thrust Takeoff section of Chapter 3.

UNCONTROLLED
IF PRINTED

Callouts

Appendix A.2.1

Both crewmembers should be continuously aware of current airplane altitude, position, energy state, configuration, and maintain situational awareness appropriate for the phase of flight.

Avoid nonessential conversation during critical phases of flight, particularly during taxi, takeoff, approach and landing. Unnecessary conversation reduces crew efficiency and alertness and is not recommended when below 10,000 feet MSL / FL100. At high altitude airports, adjust this altitude upward, as required.

Recommended callouts are provided in the interest of good Crew Resource Management (CRM). These callouts may be modified by the operator. Recommended callouts differ from procedural callouts that are found in the Procedures section of the FCOM. Procedural callouts are required.

Both pilots should check the flight instruments and Flight Mode Annunciations (FMAs) at regular intervals to verify the selections made are correct for the phase of flight. Both pilots should crosscheck their MCP selections with the FMAs to ensure the airplane is responding as expected. Unexpected FMAs should be announced, evaluated and addressed appropriately.

The Pilot Monitoring (PM) makes callouts based on instrument indications, FMAs or observations for the appropriate condition. The Pilot Flying (PF) should verify the condition/location from the flight instruments and acknowledge. If the PM does not make the callout, the PF should make it.

The PM calls out significant deviations from command airspeed or flight path. Either pilot should call out any abnormal indications of the flight instruments (flags, loss of deviation pointers, etc.).

One of the fundamentals of Crew Resource Management is that each crewmember must be able to supplement or act as a back-up for the other crewmember. Proper adherence to recommended callouts is an essential element of a well-managed flight deck. These callouts provide both crewmembers required information about airplane systems and about the participation of the other crewmember. The absence of a callout at the appropriate time may indicate a malfunction of an airplane system or indication, or indicate the possibility of incapacitation of the other pilot.



737 NG Flight Crew Training Manual

The PF should acknowledge all GPWS voice callouts except altitude callouts during approach while below 500 feet AFE. No callout is necessary from the PM if the GPWS voice callout has been acknowledged by the PF. The recommended callout of “CONTINUE” or “GO-AROUND” at minimums is not considered an altitude callout and should always be made. If the automatic electronic voice callout is not heard by the flight crew, the PM should make the callout.

Note: If automatic callouts are not available, the PM may call out radio altitude at 100 feet, 50 feet and 30 feet (or other values as required) to aid in developing an awareness of eye height at touchdown.

Recommended Callouts

	CONDITION / LOCATION	CALLOUT (Pilot Monitoring, unless noted)
Climb And Descent	Approaching Transition Altitude	“TRANSITION ALTITUDE, SET STANDARD”
	Approaching Transition Level	“TRANSITION LEVEL, ALTIMETERS SET _____” (in. or mb)
	1,000 ft. above/below assigned altitude/Flight Level (IFR)	“1,000 FEET TO LEVEL OFF”
Descent	10,000 ft. MSL / FL100 (Reduce airspeed if required) (IFR and VFR)	“10,000 FEET” or “FLIGHT LEVEL 100”

Recommended Callouts - ILS or GLS Approach

CONDITION / LOCATION	CALLOUT (Pilot Monitoring, unless noted)
First positive inward motion of localizer pointer	“LOCALIZER ALIVE”
Final approach fix inbound	“OUTER MARKER/FIX, ___ FEET”
1,000 ft. AFE	“1,000 FEET”

737 NG Flight Crew Training Manual

CONDITION / LOCATION	CALLOUT (Pilot Monitoring, unless noted)
500 ft. AFE (Check autoland status annunciator, if applicable)	“500 FEET” (F/D or single autopilot approach) Autoland status “FLARE ARMED” (Autoland callout only) Autoland status “LAND 2” or “LAND 3” or “NO AUTOLAND”
100 ft. above DA(H) (fail passive airplanes)	“APPROACHING MINIMUMS”
Individual sequence flasher lights visible	“STROBE LIGHTS”
At AH (fail operational airplanes) - check autoland status annunciator	“ALERT HEIGHT”
At DA(H) with individual approach light bars visible	“MINIMUMS - APPROACH LIGHTS / RED BARS” (if installed)
At DA(H) - Suitable visual reference established, i.e., PM calls visual cues	PF: “CONTINUE”
At DA(H) - Suitable visual reference not established, i.e., PM does not call any visual cues or only strobe lights	PF: “GO AROUND”
At minimums callout - If no response from PF	“I HAVE CONTROL _____” (state intentions)
Below DA(H) - Suitable visual reference established	“THRESHOLD/RUNWAY TOUCHDOWN ZONE”
Below DA(H) - Suitable visual reference established	PF: “LANDING”
Below DA(H) - Suitable visual reference not established, i.e., PM does not call any visual cues	PF: “GO AROUND”



737 NG Flight Crew Training Manual

Recommended Callouts - Non-ILS or Non-GLS Approach

CONDITION / LOCATION	CALLOUT (Pilot Monitoring, unless noted)
First positive inward motion of VOR or LOC course deviation indication	"COURSE/LOCALIZER ALIVE"
Final approach fix inbound	"VOR/NDB/FIX, ___ FEET"
1,000 ft. AFE	"1,000 FEET"
500 ft. AFE	"500 FEET"
100 ft. above DA(H) or MDA(H)	"APPROACHING MINIMUMS"
Individual sequence flasher lights visible	"STROBE LIGHTS"
At DA(H) or MDA(H) with individual approach light bars visible	"MINIMUMS - APPROACH LIGHTS / RED BARS" (if installed)
At DA(H) or MDA(H) - Suitable visual reference established, i.e., PM calls visual cues	PF: "CONTINUE"
At DA(H) or MDA(H)- Suitable visual reference not established, i.e., PM does not call any visual cues or only strobe lights	PF: "GO AROUND"
At minimums callout - If no response from PF	"I HAVE CONTROL _____" (state intentions)
Below DA(H) or MDA(H)- Suitable visual reference established	"THRESHOLD/RUNWAY TOUCHDOWN ZONE"
Below DA(H) or MDA(H)- Suitable visual reference established	PF: "LANDING"
Below DA (H) or MDA(H)- Suitable visual reference not established, i.e., PM does not call any visual cues	PF: "GO AROUND"

Standard Phraseology

A partial list of standard words and phrases follows:

Thrust:

- “SET TAKEOFF THRUST”
- “SET GO-AROUND THRUST”
- “SET MAXIMUM CONTINUOUS THRUST”
- “SET CLIMB THRUST”
- “SET CRUISE THRUST”

Flap Settings:

- “FLAPS UP”
- “FLAPS ONE”
- “FLAPS FIVE”
- “FLAPS TEN”
- “FLAPS FIFTEEN”
- “FLAPS TWENTY-FIVE”
- “FLAPS THIRTY”
- “FLAPS FORTY”

Airspeed:

- “SET _____ KNOTS”
- “SET VREF PLUS (additive)”
- “SET FLAPS _____ SPEED”

UNCONTROLLED
IF PRINTED

Electronic Flight Bag

This section provides guidance on the use of the optional Electronic Flight Bag (EFB). The EFB may contain some or all of the following options.

Note: As with paper charts, crews must avoid fixation on the display or distraction from primary crew duties while using any EFB application.

Airport Moving Map

The airport map display is intended to enhance crew positional awareness while planning taxi routes and while taxiing. The system is not intended to replace normal taxi methods including the use of direct visual observation of the taxiways, runways, airport signs and markings and other airport traffic. Prior to taxi, NOTAMS and airport charts (using EFB terminal charts or paper) should be consulted for the latest airport status to include closed taxiways, runways, construction, etc., since these temporary conditions are not shown on the airport map.

Crews must use direct visual observation out flight deck windows as the primary taxi navigation reference. Use the airport Heading-Up or North-Up map to provide enhanced positional awareness by:

- verifying taxi clearance and assisting in determining taxi plan (both pilots)
- monitoring taxi progress and direction (both pilots)
- alerting and updating the pilot taxiing with present position and upcoming turns and required stops (pilot not taxiing).

In flight, the airport North-Up fixed map may be used to aid in runway exit planning and anticipating the taxi route to the gate or parking spot.

If one airport map display is inoperative at dispatch, the crewmember with the inoperative display should keep a paper copy of the airport diagram readily available. During taxi in this situation, one pilot should continue to use the airport map display for positional awareness while the other pilot monitors progress on the paper chart. If an airport map display fails after dispatch and no paper backup airport diagrams are available, the crew should consider having the pilot not taxiing provide progressive taxi and positional updates to the pilot taxiing or request progressive taxi instruction from ground control. In any case, the pilot taxiing should always devote primary attention to taxiing the airplane by external visual observation. If the airport map display is inoperative on both sides, use normal taxi procedures.

Note: GPS position must be available to use the Heading-Up map.

737 NG Flight Crew Training Manual

Terminal Charts

Electronic terminal charts may be used in place of paper charts. Enroute charts may be available in the EFB. Should the airplane dispatch with one or both displays inoperative, the crew should comply with the provisions of the MEL regarding the use of backup charts.

Airplane Performance

When all appropriate entries are made, the airplane performance application provides runway specific performance information equivalent to AFM-DPI data or airline airport analysis. During approach preparation, the system can provide advisory landing distance information.

Video Surveillance

The video surveillance display may be used at the discretion of the crew to identify individuals requesting flight deck entry or for other airline-specific purposes such as passenger cabin or cargo compartment observation.

Electronic Logbook and Other Documents

The electronic logbook and other electronic documents should be used as defined by operator policy and procedures.

UNCONTROLLED
IF PRINTED

Flight Path Vector

The Flight Path Vector (FPV) displays Flight Path Angle (FPA) relative to the horizon line and drift angle relative to the center of the pitch scale on the attitude display. This indication uses inertial and barometric altitude inputs. The vertical flight path angle displayed by the FPV should be considered unreliable with unreliable primary altitude displays. The FPV can be used by the pilot in several ways:

- as a reference for establishing and maintaining level flight when the F/D is not in use or not available. When maneuvering the airplane, adjust pitch to place the FPV on the horizon. This results in zero vertical velocity
- as a crosscheck of the vertical flight path angle when established in a climb, descent, or on a visual final approach segment

Note: When on final approach, the FPV does not indicate airplane glide path relative to the runway. ILS or GLS glide slope, VASI/PAPI or other means must be used for a proper glide path indication.

- in climbs or descents, radar tilt can be adjusted to an appropriate elevation based on the displayed FPA. Radar tilt, like the FPV, is referenced to the horizon. Example: Adjusting the radar tilt to the same angle relative to the horizon as the FPV during climb results in the radar beam centered on the existing flight path
- as a qualitative indication of airplane lateral drift direction if the map is not available. The FPV moves left or right of the pitch scale to indicate the relative position of the ground track to the present heading. The amount of drift cannot be determined from this display unless the airplane is equipped with a horizon line heading scale. Example: FPV displaced to the left indicates wind component from the right and corresponding drift to the left
- for airplanes with a horizon line heading scale, the downwind track can be flown by setting the tail of the FPV on the downwind heading mark. Similarly on final approach, the FPV tail could be set to the final approach course of the runway
- as a cross-reference, when flying visual traffic patterns. On the downwind leg, the flight crew should position the FPV on the horizon line, in order to maintain level flight
- on final approach it provides a trajectory that quickly indicates a downburst. In addition, the position of the FPV in relation to the airplane symbol provides an indication of the wind direction.

Note: The FPV should not be used in reference to the PLI, which is a pitch attitude referenced display.

737 NG Flight Crew Training Manual

Vertical Situation Display

The Vertical Situation Display (VSD) (as installed) helps prevent controlled flight into terrain, and approach and landing accidents. It is a supplementary display, intended to improve situational awareness. Together with the lateral MAP, it creates a clear graphical picture of the airplane's horizontal and vertical position. In addition, it complements other safety features such as the GPWS. The VSD can be used during all phases of flight, but the main benefit is achieved during initial climb, descent, and approach. The VSD is not intended for use as a primary reference, or as a precise terrain following tool.

During departure, the VSD allows crews to recognize possible terrain conflicts more readily, before a GPWS alert is generated. This may be particularly useful if the airplane is held at low altitude for a prolonged time.

During climb and descent, the VSD allows crews to check the vertical flight profile and monitor the vertical flight path vector. This leads to earlier identification of altitude constraints that may not be met.

VSD use is encouraged as much as possible during all approaches because it assists in establishing the correct glide path. If an approach procedure contains one or more step down fixes, the crew can determine that the FMC path and the airplane current flight path angle will comply with the correct path and clear all step down fixes at or above the published altitude. Dedicated decision gates at 1,000 ft. and 500 ft. help the crew achieve a stabilized approach.

During an instrument approach using V/S, the crew can use the dashed vertical speed line to establish and monitor the vertical path. This leads to earlier recognition of an unstable approach or an inappropriate rate of descent.

For visual approaches without a published vertical path (GP angle), a 3° reference vector is displayed. Crews can adjust the flight path angle to overlay the 3° reference line to maintain a stable approach.

To improve speed stability control, crews can use the range-to-target speed symbol (green dot) to show where excess speed will be dissipated along the vertical flight path vector. If excess speed is not an issue, the symbol does not appear on the display.

Note: Flight crews need to be aware that for FMC U10.8a and earlier, if a cold temperature altitude correction is made, the final approach glide path depicted by VSD will be below the airplane's corrected VNAV/IAN glide path.

Cold Temperature Altitude Corrections

Appendix A.2.2

If the Outside Air Temperature (OAT) is different from the International Standard Atmospheric (ISA) temperature, barometric altimeter errors result due to non-standard air density. Larger temperature differences from standard result in larger altimeter errors. When the temperature is warmer than ISA, true altitude is higher than indicated altitude. When the temperature is colder than ISA, true altitude is lower than indicated altitude. Extremely low temperatures create significant altimeter errors and greater potential for reduced terrain clearance. These errors increase with higher airplane altitudes above the altimeter source.

Consider doing the Cold Temperature Altitude Corrections Supplementary Procedure (SP. 16) or the Temperature Compensation for Approach Altitudes (SP. 11), as applicable, in the FCOM when altimeter errors become appreciable, especially where high terrain and/or obstacles exist near airports in combination with very cold temperatures (-30°C/-22°F or colder). Also consider correcting en route minimum altitudes and/or flight levels where terrain clearance is a factor. In some cases corrections may be appropriate for temperatures between 0°C and -30°C.

Aircrews should note that for very cold temperatures, when flying published minimum altitudes significantly above the airport, altimeter errors can exceed 1000 feet, resulting in potentially unsafe terrain clearance if no corrections are made.

Boeing airplanes have uncompensated Baro-VNAV systems and are prohibited from using LNAV/VNAV minima on approach charts when operating outside of published temperature restriction limits. However, if cold temperature altitude corrections are applied as described in the Cold Temperature Operations Supplementary Procedures chapter of the FCOM, descent to the corrected LNAV (MDA) minima is allowed. There is no procedure for hot temperature corrections.

For airplanes with Temperature Compensation option, if cold temperature altitude corrections are applied, as described in the Automatic Temperature Compensation for Approach Altitudes Supplementary Procedures chapter of the FCOM, descent to corrected LNAV/VNAV minima is allowed if applied with applicable operationally approved procedures, as specified by the operator's regulatory authority or by the authority of the country in which the operation is conducted (including Air Traffic Control).

Operation in Icing Conditions

Boeing airplanes are certified to all applicable airworthiness regulations regarding flight in icing conditions. Operators are required to observe all operational procedures concerning flight in these conditions.

737 NG Flight Crew Training Manual

Although the process of certifying jet transport airplanes for operation in icing conditions involves many conservative practices, these practices have never been intended to validate operations of unlimited duration in severe icing conditions. The safest course of action is to avoid prolonged operation in moderate to severe icing conditions.

Some NNCs direct the flight crew to avoid icing conditions. The flight crew should make reasonable efforts to minimize exposure to icing conditions. In some circumstances flight in icing conditions may be necessary for operational reasons, such as:

- descent for landing
- fuel considerations
- terrain avoidance
- situations where increased flight time may increase risk to passenger safety.

It is the captain's responsibility to assess the situation and use good judgement to determine the safest course of action.

Ice Crystal Icing

Ice crystals at high altitude are often not considered a threat to jet transport airplanes because they don't lead to airframe icing. However, a condition exists where solid ice particles can cool interior engine surfaces through melting and ice buildup can occur. When the ice breaks off, it can result in engine power loss or damage. Symptoms can include surge, flameout or high vibration.

Typically, the engine power loss has occurred at high altitude, in clouds, as the airplane is flying above an area of convective weather where little or no airplane weather radar returns were observed at the flight altitude. In other cases, flight altitude radar returns were observed and pilots conducted the flight to avoid these areas. Despite pilot avoidance of reflected weather, engine power losses have occurred. Avoidance of ice crystals is a challenge because they are not easily identified.

Boeing has been an integral part of ongoing studies to better understand ice crystal icing. For more detailed information on this subject, see the Boeing Flight Operations Technical Bulletin titled Ice Crystal Icing. This bulletin provides information about actual events, including those experiencing engine power loss and damage associated with flight in ice crystal icing. It also provides methods of recognizing ice crystal icing conditions and suggested actions if ice crystal icing is suspected. An Ice Crystal Icing Supplementary Procedure is also available in the Adverse Weather section, Volume 1 of the FCOM.

Note: An Ice Crystal Icing NNC is available in the QRH.

Training Flights

Multiple approaches and/or touch and go landings in icing conditions may result in significant ice accumulations beyond those experienced during typical revenue flights. This may result in fan blade damage as a result of ice accumulation on unheated surfaces shedding into the engines.

Recommended Rudder Trim Technique

This section describes two techniques for properly trimming the rudder. It is assumed that the airplane is properly rigged and in normal cruise. The primary technique uses rudder trim only to level the control wheel and is an acceptable and effective method for trimming the airplane. It is approximately equal to a minimum drag condition. This technique is usable for normal as well as many non-normal conditions. For some non-normal conditions, such as engine failure, this technique is the preferred method and provides near minimum drag.

The alternate technique may provide a more accurate trim condition when the roll is caused by a roll imbalance. In addition, this technique outlines the steps to be taken if the primary trim technique results in an unacceptable bank angle or excessive rudder trim. The alternate technique uses both rudder and aileron trim to neutralize a rolling condition using the bank pointer as reference.

Note: Large trim requirements may indicate the need for maintenance and should be noted in the airplane log.

Drag Factors Due to Trim Technique

If the control wheel is displaced to the point of spoiler deflection a significant increase in aerodynamic drag results. Additionally, any rigging deviation that results in early spoiler actuation causes a significant increase in drag per unit of trim. These conditions result in increased fuel consumption. Small out of trim conditions affect fuel flow by less than 1%, if no spoilers are deflected.

Note: Aileron trim may be required for significant fuel imbalance, airplane damage, or flight control system malfunctions.

Primary Rudder Trim Technique

It is recommended that the autopilot remain engaged while accomplishing the primary rudder trim technique (using rudder trim only). After completing this technique, if the autopilot is disengaged, the airplane should maintain a constant heading.

737 NG Flight Crew Training Manual

The following steps define the primary rudder trim technique:

- set symmetrical thrust
- balance fuel if required
- ensure the autopilot is engaged in HDG SEL and stabilized for at least 30 seconds
- trim the rudder in the direction corresponding to the down (low) side of the control wheel until the control wheel indicates level. The indices on top of the control wheel should be used to ensure a level wheel condition. The airplane is properly trimmed when the control wheel is level, (zero index). As speed, gross weight, or altitude change, trim requirements may also change. In a proper trim condition, there may be a slight forward slip (slight bank angle indicated on the bank pointer) and a slight deflection of the slip/skid indicator, which is acceptable.

Alternate Rudder Trim Technique

The alternate rudder trim technique is used if the primary trim technique results in an unacceptable bank angle, excessive rudder trim, or if a more accurate dual axis trim is required.

The following steps define the alternate rudder trim technique:

- set symmetrical thrust
- balance fuel if required
- verify rudder trim is zero
- ensure the autopilot is engaged in HDG SEL and stabilized for at least 30 seconds
- trim the rudder in the direction corresponding to the down (low) side of the control wheel until the bank indicates level (no bank angle indicated on the bank pointer). Apply rudder trim incrementally, allowing the bank to stabilize after each trim input. Large trim inputs are more difficult to coordinate. The airplane is properly trimmed when the bank angle on the bank pointer indicates zero. If the airplane is properly rigged, the control wheel should indicate approximately level. The resultant control wheel condition indicates the true aileron (roll) trim of the airplane being used by the autopilot.

After completing the alternate rudder trim technique, if the autopilot is disengaged the airplane may have a rolling tendency. Hold the wings level using the bank pointer as reference. Trim out any control wheel forces using the aileron trim switches. If properly trimmed, the airplane holds a constant heading and the aileron trim reading on the wheel/column agrees with what was seen while the autopilot was engaged. Aileron trim inputs require additional time and should be accomplished prior to final approach. When aileron trim inputs are complete the autopilot may be re-engaged as desired.

Flight Management Computer(s)/CDUs

The Flight Management System provides the crew with navigation and performance information that can result in a significant crew workload reduction. This workload reduction is fully realized when the system is operated as intended, including proper preflight and timely changes in flight. FMC guidance must always be monitored after any in flight changes. If flight plan changes occur during periods of high workload or in areas of high traffic density, the crew should not hesitate to revert to modes other than LNAV/VNAV.

During preflight, all flight plan or performance related FMC CDU entries made by one pilot must be verified by the other pilot. In flight FMC CDU changes should be made by the PM and executed only after confirmation by the PF.

FMC Route Verification Techniques

After entering the route into the FMC, the crew should verify that the entered route is correct. There are several techniques that may be used to accomplish this. The crew should always compare:

- the filed flight plan with the airways and waypoints entered on the ROUTE pages
- the computer flight plan total distance and estimated fuel remaining with the FMC-calculated distance to destination and the calculated fuel remaining at destination on the PROGRESS page.

For longer flights and flights that are planned to transit oceanic airspace, the crew should crosscheck the LEGS page with the computer flight plan to ensure that the waypoints, magnetic or true tracks, and distances between waypoints match.

If there is a discrepancy noted in any of the above, correct the LEGS page to match the filed flight plan legs. A crosscheck of the map display using the plan mode may also assist in verification of the flight plan.

When pilots are evaluating the charted procedure against the navigation database, the areas of primary concern are: waypoint sequence, speed and altitude constraints, and no unexpected discontinuities. Minor differences between the magnetic heading or track on a navigation chart and the heading or track in the FMC may exist. Primarily, this is because the FMC has a lookup table for magnetic variation, but chart designers apply a local magnetic variation. Minor differences may also result from equipment manufacturer's application of magnetic variation. These minor differences are operationally acceptable.

737 NG Flight Crew Training Manual

FMC Performance Predictions

FMC performance predictions are based on the airplane being in a normal configuration and at normal thrust settings. These predictions include:

- climb and descent path predictions including top of climb and top of descent
- ECON, LRC, holding, and engine out speeds
- altitude capability
- step climb points
- fuel remaining at waypoints and destination or alternate
- Estimated Time of Arrival (ETA) at waypoints and destination or alternate
- holding time available.

Non-normal Configurations or Reduced Thrust

If operating in a non-normal configuration, such as gear down, flaps extended, spoilers extended, etc., or if operating at reduced thrust due to a non-normal condition, the above performance predictions are inaccurate.

FMC fuel predictions are based on a clean configuration at normal thrust settings. Fuel consumption may be significantly higher than predicted in other configurations. Fuel consumption can be significantly different than predicted when operating at a reduced thrust setting. Estimates of fuel remaining at waypoints, the destination or an alternate can be computed by the crew based on current fuel flow indications and should be updated frequently.

An accurate ETA is available if the current speed or Mach is entered into the VNAV cruise page.

Performance predictions for gear down altitude capability and gear down cruise performance are available in the Performance Inflight (PI) Chapter of the Quick Reference Handbook (QRH).

Note: VNAV PTH operation for approaches is usable for non-normal configurations.

Holding time available is accurate only in the clean configuration provided the FMC holding speed is maintained.

RNAV Operations

This section provides definitions of terms associated with RNAV and describes basic concepts to include phase of flight navigation for radius-to-fix (RF) legs, terminal (SIDs and STARs), en-route, and approach operations.

RNAV or area navigation is a method of navigation that allows aircraft to fly on any desired flight path within the coverage of referenced NAVAIDS or within the limits of the capability of self-contained systems, or a combination of these capabilities.

All Boeing FMCs are capable of performing RNAV operations. Regarding navigation accuracy, these FMCs differ only by demonstrated RNP capabilities and the ability to use GPS updating.

En-route operations can be defined as oceanic and domestic. Oceanic RNAV requirements are described in detail in the applicable NAT HLA guidance material such as the Pacific or North Atlantic manuals. Specific routes or areas of operation are given RNP based on route separation requirements. RNP 10 routes are suitable for all FMCs that are capable of GPS updating and those FMCs that cannot update from GPS but have received the last radio update within the previous six hours.

In general, oceanic operations require dual navigation systems (dual FMC or single FMC in combination with alternate navigation capability).

RNP and ANP Definitions

RNP (Required Navigation Performance) is a specified navigation performance for route, terminal, or approach procedures. It is a measure of the navigation performance accuracy necessary for operations within a defined airspace. It is shown in nautical miles. All RNP based procedures have an associated RNP level that is published on the procedure chart.

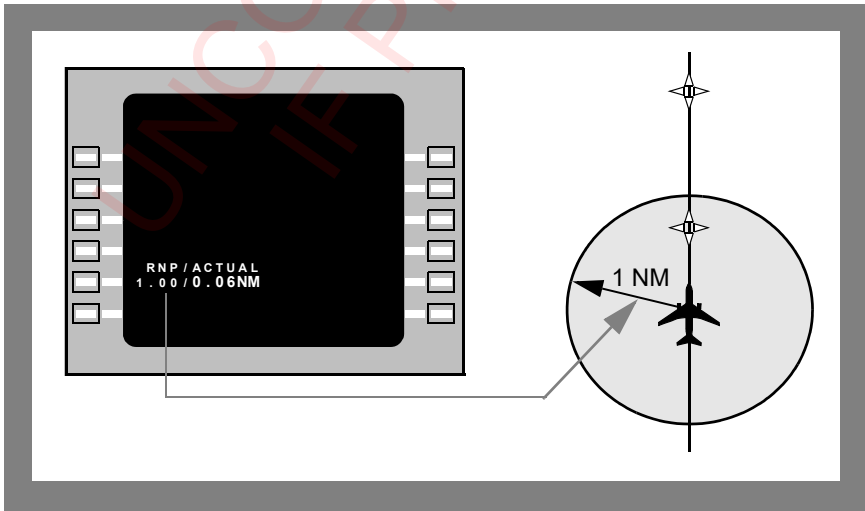

737 NG Flight Crew Training Manual

Oceanic RNP operations are generally 4.0 or higher. Domestic en-route RNAV operations depend on the availability of radio updating (DME-DME) sources to support domestic RNP operations. The following domestic RNP operations are fully supported by any Boeing FMC with DME-DME or GPS updating active:

- USA and Canada - RNP 2.0 or higher, RNAV-1, and RNAV-2
- Europe - B-RNAV (RNP 5.0)
- Asia - As specified for the route or area (e.g. RNP 4 or RNP 10 routes)
- Africa - As specified for the route or area.

Terminal RNAV operations (SIDs, STARs and Transitions) are fully compatible with all FMCs with DME-DME or GPS updating active and are defined as:

- USA and Canada - RNP 1.0 SIDs and STARs
- Europe - P-RNAV (RNP 1.0).

RNAV approaches are compatible with all FMCs provided DME-DME or GPS updating is active at the beginning of the approach and the approach RNP is equal to or greater than the minimum demonstrated RNP in the AFM. Restrictions published on some RNAV approaches may preclude their use without GPS updating active. Approach RNP can be as low as 0.10 NM.

UNCONTROLLED
IF PRINTED

For approaches, all Boeing FMCs have RNP 0.5 capability with DME-DME updating active without GPS updating. See the Approach section of this manual for further details regarding the techniques for flying RNAV approaches.

ANP (Actual Navigation Performance) is the FMC calculated certainty of the airplane's position in nautical miles. It is situation information for the flight crew representing a system estimate of the radius of the area in which the actual position of the airplane lies. The system uses the best available sensor(s) to minimize positioning error. The flight crew or autoflight system must track the RNAV path using LNAV.

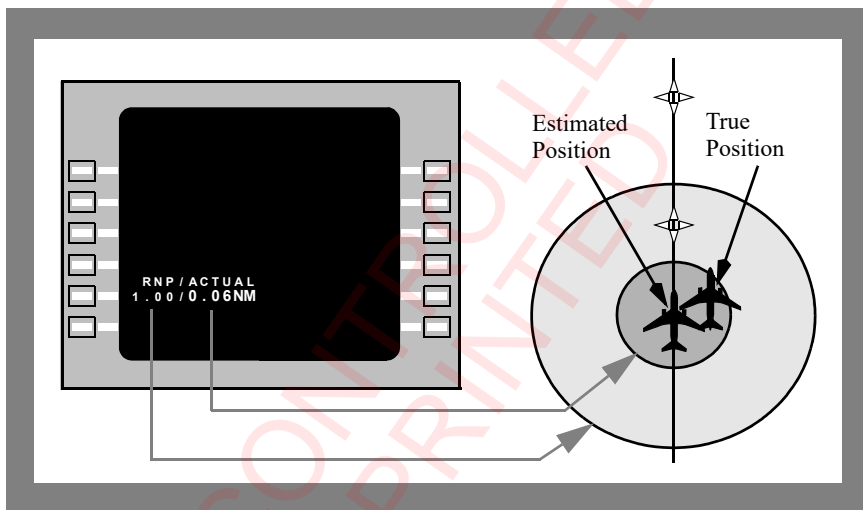

Basic RNP Concept

[Appendix A.2.2](#)

RNP is RNAV operations with on-board navigation performance monitoring and alerting. RNP was developed as a method for certifying the navigation capability for RNAV systems that can use multiple sensors for position updating. Navigation performance within the RNP level assures traffic and terrain separation. RNAV (RNP) procedures must be flown as published in the navigation database. Pilot defined routes and lateral or vertical route modifications are not allowed.

RNAV (RNP) AR (Authorization Required) procedures are RNP approaches that require special aircraft and aircrew authorization. For specific instructions refer to Chapter 5, Instrument Approach - RNAV (RNP) AR.

737 NG Flight Crew Training Manual

The FMC uses one of the following as the displayed RNP:

- default RNP - FMC default values are set by the FMC and are displayed if no RNP is available from the navigation database or one has not been manually entered
- navigation database RNP values (if available) are displayed based on values associated with the procedure. These values may be unique for certain segments or terminal procedures
- manually entered RNP - remains until changed or deleted.

The crew may need to make a manual RNP entry if the displayed RNP for the route or procedure is incorrect. Setting an RNP smaller than what is specified for the procedure, airspace, or route, may cause nuisance crew alerts. If the RNP is set larger than that specified for a procedure or segment, crew alerting may occur at the incorrect RNP (if the specified RNP is exceeded). The RNP is depicted on the published procedure being flown.

Although today's airspace design has already established certain lateral limits (RNP), no Vertical Required Navigation Performance limits are published. Vertical Required Navigation Performance is available on some FMCs and may be used for certain descent profiles such as Continuous Descent Approaches (CDA), Optimized Profile Descents (OPD) or Tailored Arrivals (TA).

The FMC calculates, monitors and displays ANP as described in the FCOM. Crews should note that ANP is only related to the accuracy of FMC position.

Airplanes with Navigation Performance Scales (NPS)

For airplanes with Navigation Performance Scales (NPS) the flight crew can monitor the dynamic relationship between ANP, RNP, and current flight path deviations. The lateral and vertical deviation scales are based on the familiar concepts of a centerline indication, scale limits, and a deviation pointer and provide the flight crew with a clear indication of current position in relation to desired position and the total allowable error. Full scale lateral and vertical deviation for NPS is equal to the FMC RNP value. If the deviation approaches the limit, a correction back to the path is needed. Reference the FCOM for specific NPS system indications and description.

During RNP operations other than approach, anytime the deviation exceeds the limit or an amber deviation alert occurs, the crew may have to select a different autopilot roll or pitch mode or manually fly airplane back on course. If unable to comply, the flight crew must revert to other means of navigation such as conventional ground-based or radar navigation.

During RNP approach operation, anytime the deviation exceeds the limit or an amber deviation alert occurs the crew may change to a non-RNP procedure. If unable, the crew should execute a missed approach unless suitable visual reference is already established. In the event of a missed approach, the crew may consider requesting an alternate clearance.

Airplanes without Navigation Performance Scales (NPS)

For airplanes without NPS, the crew must refer to the FMC PROGRESS page for XTK and VTK information during the approach.

If a deviation occurs, and the correction back to course is not immediate, then the PM should refer to the FMC PROGRESS page and notify the PF if the maximum allowable deviations are reached. Normally XTK should not exceed $1.0 \times \text{RNP}$ during RNP operations.

Note: An excessive cross-track error does not result in a crew alert.

During RNP operations other than approach, anytime the deviation exceeds the limit, the crew may have to select a different autopilot roll or pitch mode or manually fly the airplane back on course. If unable to comply, the flight crew must revert to other means of navigation such as conventional ground-based or radar navigation.

During RNP approach operation, anytime the deviation exceeds the limit the crew may change to a non-RNP procedure. If unable the crew should execute a missed approach unless suitable visual reference is already established. In the event of a missed approach, the crew may consider requesting an alternate clearance.

ANP Alerts

When ANP exceeds RNP, an UNABLE REQD NAV PERF - RNP alert is displayed. If this occurs during RNP operations other than approach, the crew should verify position, confirm updating is enabled, and consider requesting an alternate clearance. This may mean changing to a non-RNP procedure or route or changing to a procedure or route with a RNP higher than the displayed ANP value.

If the alert occurs during RNP approach operation, the crew may change to a non-RNP procedure. If unable, the crew should execute a missed approach unless suitable visual reference is already established. In the event of a missed approach, the crew may consider requesting an alternate non-RNP clearance.

Autoflight Use During RNP

Normally, a route segment or procedural leg is defined by its required width. For RNP operations, route width is normally equal to at least $2.0 \times \text{RNP}$ from either side of the LNAV course. Required width is determined by minimum terrain or traffic clearance requirements. The probability of exceeding this maximum deviation while in LNAV with the autopilot engaged is very small. For each airplane type, minimum demonstrated RNP values are given in the AFM. These minimum values vary depending on LNAV, flight director and autopilot use, and whether GPS is the active source of position updating.

737 NG Flight Crew Training Manual

RNP operations require appropriate path tracking consistent with the RNP level. LNAV together with the flight director and the autopilot may be required for certain low RNP operations. Use of the autopilot and LNAV normally provides the required path tracking accuracy. During RNAV approaches using VNAV, VNAV PTH is required for any leg segment with a coded glide path angle. These procedures show only LNAV/VNAV approach minima and do not allow use of LNAV only. Use of the flight director alone may not provide sufficient guidance to maintain the path accurately.

Note: If the autopilot is not available, flight crews should use the flight director and the additional cues displayed on the navigation display (position trend vector, airplane symbol, and digital cross track deviation) with at least one map set at a range of 10 NM or less.

Radius-to-Fix (RF) Legs

RF legs are waypoints connected by a constant radius course similar to a DME arc. These are shown on terminal procedures as a curved track between two or more waypoints. Some considerations regarding use of RF legs:

- there may be a maximum speed shown on some straight legs or some RF legs of smaller radius. This limitation is critical for the crew to observe since the ability of the AFDS to track the RF leg is determined by ground speed and maximum available bank angle. In high tailwinds, the resulting ground speed may cause the maximum bank angle to be reached. In this situation, excessive course deviation may occur if the maximum RF speed is exceeded
- do not begin a procedure by proceeding direct to an RF leg. This may cause excessive deviation when the airplane maneuvers to join the RF leg. Normally there is a track-to-fix leg prior to an RF leg to ensure proper RF leg tracking
- intercept course to or direct to route modifications delete an RF leg if done to the second waypoint on an RF leg
- if a go-around is executed while on an RF leg, it is important to immediately re-select LNAV (or verify that LNAV has re-engaged for airplanes equipped with the TO/GA to LNAV feature) to avoid excessive course deviation. GA roll mode is a track hold mode and is not compatible with low RNP operations if left engaged. The pilot flying must continue to track the LNAV course using the map display as a reference until LNAV is re-engaged.

If a temporary loss of the FMC occurs, the active RF leg will appear after a discontinuity when the FMC returns to normal operation. Once the route is activated and the EXEC key is pressed, use of the INTC ARC function is needed to achieve LNAV capture of the RF leg if the situation permits.

GPS Use in Non-WGS-84 Reference Datum Airspace

Appendix A.2.3

In non-WGS-84 airspace, the local datum (position basis) used to survey the navigation database position information may result in significant position errors from a survey done using the WGS-84 datum. To the pilot, this means that the position of runways, airports, waypoints, nav aids, etc., may not be as accurate as depicted on the map display and may not agree with the GPS position.

Using the FMC while receiving GPS position updating during SIDS, STARS and enroute navigation meets the required navigation accuracy in non-WGS-84 airspace. This navigation position accuracy may not be adequate for approaches, therefore the AFM requires the crew to inhibit GPS position updating while flying approaches in non-WGS-84 airspace “unless other appropriate procedures are used.”

Weather Radar and Terrain Display Policy

Whenever the possibility exists for adverse weather and terrain/obstacles near the intended flight path, one pilot should monitor the weather radar display and the other pilot should monitor the terrain display. The use of the terrain display during night or IMC operations, on departure and approach when in proximity to terrain/obstacles, and at all times in non-radar environments is recommended.

Note: It may be useful to show the terrain display at other times to enhance terrain/situational awareness.

AFDS Guidelines

Appendix A.2.3

Crewmembers must coordinate their actions so that the airplane is operated safely and efficiently.

The Normal Procedures Introduction in Volume 1 of the FCOM states that normal procedures are written for the trained flight crew and assume full use of all automated features. This statement is not intended to prevent pilots from flying the airplane manually. Manual flight is encouraged to maintain pilot proficiency, but only when conditions and workload for both the pilot flying and pilot monitoring are such that safe operations are maintained. Many operators have developed an automation use policy that gives pilots the opportunity to maintain proficiency in manual flight.

737 NG Flight Crew Training Manual

Autopilot engagement should only be attempted when the airplane is in trim, F/D commands (if the F/D is on) are essentially satisfied and the airplane flight path is under control. The autopilot is not certified nor designed to correct a significant out of trim condition or to recover the airplane from an abnormal flight condition and/or unusual attitude.

Autothrottle Use

Autothrottle use is recommended during takeoff and climb in either automatic or manual flight. During all other phases of flight, autothrottle use is recommended only when the autopilot is engaged in CMD.

During engine out operations, Boeing recommends disconnecting the autothrottle and keeping the throttle of the inoperative engine in the CLOSE position. This helps the crew recognize the inoperative engine and reduces the number of unanticipated thrust changes.

Note: The autothrottle logic on some airplanes allows the autothrottle to be physically connected during engine out operations.

Autothrottle ARM Mode

The autothrottle ARM mode is normally not recommended because its function can be confusing. The primary feature the autothrottle ARM mode provides is minimum speed protection in the event the airplane slows to minimum maneuver speed. Other features normally associated with the autothrottle, such as gust protection, are not provided. The autothrottle ARM mode should not be used with Non-Normal Checklists. Some malfunctions that affect maneuver speeds cause the autothrottle to maintain a speed above approach speed.

Manual Flight

The PM should make AFDS mode selections at the request of the PF. Heading and altitude changes from air traffic clearances and speed selections associated with flap position changes may be made without specific directions. However, these selections should be announced, such as, "HEADING 170 SET". The PF must be aware such changes are being made. This enhances overall safety by requiring that both pilots are aware of all selections, while still allowing one pilot to concentrate on flight path control.

Ensure the proper flight director modes are selected for the desired maneuver. If the flight director commands are not to be followed, the flight director should be turned off.

Automatic Flight

Autoflight systems can enhance operational capability, improve safety, and reduce workload. Automatic approach and landing, Category III operations, and fuel-efficient flight profiles are examples of some of the enhanced operational capabilities provided by autoflight systems. Maximum and minimum speed protections are among the features that can improve safety. LNAV, VNAV, and instrument approaches using VNAV are some of the reduced workload features. Varied levels of automation are available. The pilot decides what level of automation to use to achieve these goals by selecting the level that provides the best increase in safety and reduced workload.

Note: When the autopilot is in use, the PF makes AFDS mode selections. The PM may select new altitudes, but must ensure the PF is aware of any changes. Both pilots must monitor AFDS mode annunciations and the current FMC flight plan.

Automatic systems give excellent results in the vast majority of situations. Deviations from expected performance are normally due to an incomplete understanding of their operations by the flight crew. When the automatic systems do not perform as expected, the pilot should reduce the level of automation until proper control of path and performance is achieved. For example, if the pilot failed to select the exit holding feature when cleared for the approach, the airplane will turn outbound in the holding pattern instead of initiating the approach. At this point, the pilot may select HDG SEL and continue the approach while using other automated features. A second example, if the airplane levels off unexpectedly during climb or descent with VNAV engaged, LVL CHG may be selected to continue the climb or descent until the FMC can be programmed.

Early intervention prevents unsatisfactory airplane performance or a degraded flight path. Reducing the level of automation as far as manual flight may be necessary to ensure proper control of the airplane is maintained. The pilot should attempt to restore higher levels of automation only after airplane control is assured. For example, if an immediate level-off in climb or descent is required, it may not be possible to comply quickly enough using the AFDS. The PF should disengage the autopilot and level off the airplane manually at the desired altitude. After level off, set the desired altitude in the MCP, select an appropriate pitch mode and re-engage the autopilot.

737 NG Flight Crew Training Manual

Control Wheel Steering

After autopilot engagement, the airplane may be maneuvered using the control wheel steering (CWS) pitch mode, roll mode, or both using the control wheel and column. Manual inputs by the pilot using CWS are the same as those required for manual flight. Climbs and descents may be made using CWS pitch while the roll mode is in HDG SEL, LNAV or VOR/LOC. Autopilot system feel control is designed to simulate control input resistance similar to manual flight. Refer to the FCOM for a more detailed description of CWS operation.

Recommended Pitch and Roll Modes

If the LEGS page and map display reflect the proper sequence and altitudes, LNAV and VNAV are recommended. If LNAV is not used, use an appropriate roll mode. When VNAV is not used, the following modes are recommended:

LVL CHG is the preferred mode for altitude changes of 1,000 feet or more. V/S is preferred if the altitude change is less than 1,000 feet.

If unplanned speed or altitude restrictions are imposed during the arrival, the continued use of VNAV may induce an excessive workload. If this occurs, use LVL CHG or V/S as appropriate.

MCP Altitude Setting Techniques Using VNAV

When using VNAV for published instrument departures, arrivals, and approaches, the following recommendations should avoid unnecessary level-offs while ensuring minimum altitudes are met.

If waypoints with altitude constraints are not closely spaced, the normal MCP altitude setting technique is recommended.

If waypoints with altitude constraints are closely spaced to the extent that crew workload is adversely affected and unwanted level-offs are a concern, an alternate MCP altitude setting technique can be used with operator approval.

Note: When the alternate MCP altitude setting technique is used, the selection of a pitch mode other than VNAV PTH or VNAV SPD will result in risk of violating altitude constraints.

Normal MCP Altitude Setting Technique using VNAV

The following MCP altitude setting technique is normally used during published instrument departures, arrivals, and approaches when waypoints with altitude constraints are not closely spaced:

- during climbs, maximum or hard altitude constraints should be set in the MCP. Minimum crossing altitudes need not be set in the MCP. The FMC alerts the crew if minimum altitude constraints will not be satisfied
- during descent, set the MCP altitude to the next constraint or clearance altitude, whichever will be reached first
- just prior to reaching the constraint, when compliance with the constraint is assured, and cleared to the next constraint, reset the MCP to the next constraint.

In the following example, the airplane has been cleared from cruise level to “Descend Via” a STAR with published altitude constraints at or above FL 190 and at 13,200 feet. During descent, when the crew confirms the airplane will be at or above FL 190 for the corresponding waypoint, set the MCP to 13,200 feet.

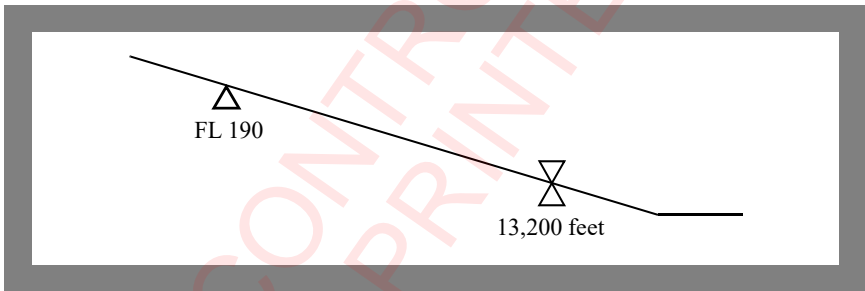

Alternate MCP Altitude Setting Technique using VNAV

Appendix A.2.4

When approved by the operator, the following MCP altitude setting technique may be used during published instrument departures, arrivals, and approaches where altitude constraints are closely spaced to the extent that crew workload is adversely affected and unwanted level-offs are a concern:

- for departures, set the highest of the closely-spaced constraints
- for arrivals, initially set the lowest of the closely spaced altitude constraints or the FAF altitude, whichever is higher

Note: When approved by the operator, this technique may also be used for Tailored Arrivals (TA) regardless of how closely the altitude constraints are spaced.

737 NG Flight Crew Training Manual

In the following example, the airplane has been cleared from cruise level to “Descend Via” a STAR with published altitude constraints at or above FL 190, followed by three additional descent constraints, the lowest being at 13,200 feet. In this case, when the crew confirms the airplane will be at or above FL 190 for the corresponding waypoint, set the MCP to 13,200 feet, even though there are two altitude constraints before 13,200 feet.

Note: When using the alternate technique, the FMC generated path should be checked against each altitude constraint to ensure that the path complies with all constraints.

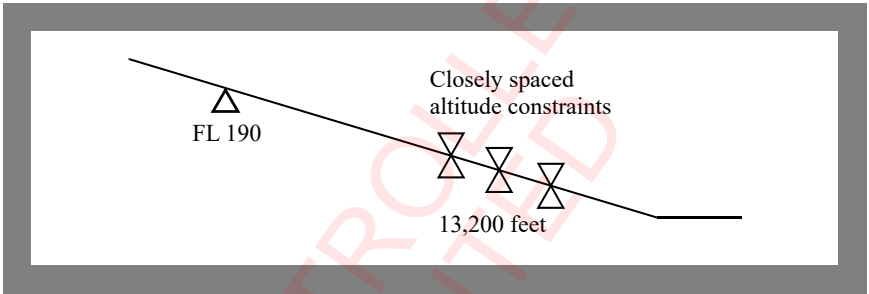

AFDS Mode Control Panel Faults

In-flight events have occurred where various AFDS pitch or roll modes, such as LNAV, VNAV or HDG SEL became un-selectable or ceased to function normally. Typically, these types of faults do not generate a failure annunciation. These faults may be caused by an MCP hardware (switch) problem.

If an AFDS anomaly is observed where individual pilot-selected AFDS modes are not responding normally to MCP switch selections, attempt to correct the problem by disengaging the autopilot and selecting both flight director switches to OFF. This clears all engaged AFDS modes. When an autopilot is re-engaged or a flight director switch is selected ON, the AFDS default pitch and roll modes should engage. The desired AFDS pitch and roll modes may then be selectable.

If this action does not correct the fault condition, the desired flight path can be maintained by selecting an alternate pitch or roll mode. Examples are included in the following table:



Inoperative or Faulty Autopilot Mode	Suggested Alternate Autopilot Mode or Crew Technique
HDG SEL	Set desired heading, disengage AFDS and manually roll to the desired heading, and re-engage the AFDS. The AFDS will hold the established heading.
LNAV	Use HDG SEL to maintain the airplane track on the active route.
VNAV SPD or VNAV PTH (climb or descent)	Use LVL CHG or V/S.
VNAV PTH (cruise, descent)	Use altitude hold. If altitude hold is not directly selectable, use LVL CHG to automatically transition to altitude hold.
VNAV PTH (approach)	Use V/S. Monitor and fly the approach referencing glidepath.
VOR/LOC	Use HDG SEL. Monitor and fly the approach referencing localizer raw data.
G/S	Use V/S to descend on an ILS or GLS approach. Monitor and fly the approach referencing glide slope raw data.

Head Up Display

The Head Up Display (HUD) is a display system that allows a pilot to maintain head-up, eyes-out during all phases of flight while still monitoring performance and flight path guidance information. HUD use is encouraged at all times as it enhances the crew capability to monitor the airplane's behavior and performance while maintaining visual lookout. There are no restrictions on the use of the HUD.

Using the HUD during approach can enhance the accuracy of path control during the approach and the touchdown. Although touch down sink rates, lateral errors and along track errors can be decreased through use of the head-up Flight Path Vector (FPV), landings are done by visual reference.

The FPV displayed on the HUD indicates airplane flight path. When control inputs are made to airplane attitude or thrust, the rate that the airplane responds to these inputs varies with conditions. The FPV shows the airplane response to the control inputs as they take effect.

737 NG Flight Crew Training Manual

Airplanes equipped with dual HUDs allow the PM full awareness of the airplane performance and flight guidance information in the same format as the PF. This provides a quicker understanding of the actions taken by the PF which allows more time for the remainder of the required crosschecks. This head-up, eyes-out monitoring ability for both pilots is one of the main differences between airplanes equipped with dual HUDs and those airplanes equipped with a single HUD.

New HUD users may notice a tendency to focus attention on one layer of information (e.g., the HUD symbology) at the expense of the other (e.g., the outside environment). The following techniques will help crews to gain the best use from the HUD:

- adjust the brightness so the pilot can see the symbology on the HUD and can see through it
- the PF looks through the HUD symbology to use normal outside cues
- the PM uses a continual scan technique
- pilots will be less susceptible the more they use the HUD and practice the attention shifting techniques.

Note: Flight director mode annunciations on the HUD are similar to F/D mode annunciations on the FMA except armed modes may not be annunciated.

The HUD may be used at any altitude. The horizon line on the HUD is only aligned with the actual horizon at 0 ft. AGL. As altitude increases, a separation between the actual horizon and the horizon line on the HUD is visible. This separation is due to the curvature of the earth. At cruising altitudes, there can be a significant separation between the horizon line on the HUD and the actual horizon.

Techniques for using the HUD in various phases of flight are described in the applicable chapters of this manual.

Pilot Incapacitation

Pilot incapacitation occurs frequently compared with other routinely trained non-normal conditions. It has occurred in all age groups and during all phases of flight. Incapacitation occurs in many forms ranging from sudden death to subtle, partial loss of mental or physical performance. Subtle incapacitations are the most dangerous and they occur the most frequently. Incapacitation effects can range from loss of function to unconsciousness or death.

The key to early recognition of pilot incapacitation is the regular use of crew resource management concepts during flight deck operation. Proper crew coordination involves checks and crosschecks using verbal communications. Routine adherence to standard operating procedures and standard profiles can aid in detecting a problem. Suspicion of some degree of gross or subtle incapacitation should also be considered when a crewmember does not respond to any verbal communication associated with a significant deviation from a standard procedure or standard flight profile. Failure of any crewmember to respond to a second request or a checklist response is cause for investigation.

If you do not feel well, let the other pilot know and let that pilot fly the airplane. During flight, crewmembers should also be alert for incapacitation of the other crewmember.

Crew Action Upon Confirming Pilot Incapacitation

If a pilot is confirmed to be incapacitated, the other pilot should take over the controls and check the position of essential controls and switches.

- after ensuring the airplane is under control, engage the autopilot to reduce workload
- declare an emergency
- use the cabin crew (if available). When practical, try to restrain the incapacitated pilot and slide the seat to the full-aft position. The shoulder harness lock may be used to restrain the incapacitated pilot
- flight deck duties should be organized to prepare for landing
- consider using help from other pilots or crewmembers aboard the airplane.

Moderate to Heavy Rain, Hail, or Sleet

The airplane is designed to operate satisfactorily when maximum rates of precipitation are encountered. However, flight into moderate to heavy rain, hail, or sleet could adversely affect engine operations and should be avoided, whenever possible. If moderate to heavy rain, hail, or sleet is encountered, reducing airspeed can reduce overall precipitation intake. Also, maintaining an increased minimum thrust setting can improve engine tolerance to precipitation intake, provide additional stall margin, and reduce the possibility of engine instability or thrust loss.

Reference the Supplementary Procedure for Moderate to Heavy Rain, Hail, or Sleet for more information. The Supplementary Procedure recommends that the crew should consider starting the APU, if available, because it provides quick access to backup electrical and pneumatic sources.

Turbulent Air Penetration

Severe turbulence should be avoided if at all possible. However, if severe turbulence is encountered, use the Severe Turbulence procedure listed in the Supplementary Procedures chapter of the FCOM. Turbulent air penetration speeds provide high/low speed margins in severe turbulent air.

During manual flight, maintain wings level and smoothly control attitude. Use the attitude indicator as the primary instrument. In extreme updrafts or downdrafts, large altitude changes may occur. Do not use sudden or large control inputs. After establishing the trim setting for penetration speed, do not change pitch trim. Allow altitude and airspeed to vary and maintain attitude. However, do not allow the airspeed to decrease and remain below the turbulent air penetration speed because stall/buffet margin is reduced. Maneuver at bank angles below those normally used. Set thrust for penetration speed and avoid large thrust changes. Flap extension in an area of known turbulence should be delayed as long as possible because the airplane can withstand higher gust loads with the flaps up.

Turbulence at any altitude can momentarily increase the airplane's angle of attack and activate the stick shaker. When flying at speeds near the lower amber band, any maneuvering increases the load factor and further reduces the margin to buffet onset and stick shaker.

Normally, no changes to cruise altitude or airspeed are required when encountering moderate turbulence. If operating at cruise thrust limits, it may be difficult to maintain cruise speed. If this occurs, select a higher thrust limit (if available) or descend to a lower altitude.



Intentionally
Blank

UNCONTROLLED
IF PRINTED



Ground Operations

Chapter 2

Table of Contents

Section TOC

Preface 2.1

Preflight 2.1

 Static Port Obstructions 2.1

 Setting the Cabin Pressure Control System 2.1

Takeoff Briefing 2.2

Push Back or Towing 2.2

Taxi 2.3

 Taxi General 2.3

 Flight Deck Perspective 2.4

 Thrust Use 2.5

 Backing with Reverse Thrust 2.5

 Taxi Speed and Braking 2.5

 Antiskid Inoperative 2.7

 Nose Wheel/Rudder Pedal Steering 2.7

 Turning Radius and Gear Tracking 2.8

 Visual Cues and Techniques for Turning while Taxiing 2.9

 Sharp Turns to a Narrow Taxiway 2.10

 Turns of 180 Degrees 2.11

 Taxi - Adverse Weather 2.16

 Engine Out Taxi 2.17



Intentionally
Blank

UNCONTROLLED
IF PRINTED



Preface

This chapter outlines the recommended operating practices and techniques during ground operations, including pushback, engine start and taxi. Taxi operations during adverse weather are also addressed. The recommended operating practices and techniques discussed in this chapter improve crew coordination, enhance safety and provide a basis for standardization.

Preflight

Static Port Obstructions

Fluctuating and inaccurate airspeed and altimeter indications after takeoff have been attributed to static ports obstructed by ice formed while the airplane was on the ground. Precipitation or water rundown after snow removal may freeze on or near the static ports. This may cause an ice buildup which disturbs airflow over the static ports resulting in erroneous airspeed and altimeter readings, even when static ports appear to be clear. Since static ports and the surrounding surfaces are not heated when probe heat is activated, a thorough preflight inspection and clearing of all contaminants around the static ports are critical.

The aircrew should pay particular attention to the static ports during the exterior inspection when the airplane has been subjected to freezing precipitation. Clear ice on the static ports can be difficult to detect. If in doubt, contact maintenance for assistance.

Setting the Cabin Pressure Control System

The Cabin Pressure Control System allows the flight crew to set the planned cruise flight altitude (FLT ALT) and the altitude of the intended landing field (LAND ALT). These altitudes are then used by the pressurization system to calculate a pressure schedule specific to the planned flight. The pressurization system is designed to maintain a comfortable and safe cabin altitude throughout the duration of the flight based on the FLT ALT and LAND ALT set during preflight. The only time a change in FLT ALT or LAND ALT is required in flight is when the final cruise or landing altitude is different than that selected during preflight.

Investigation of pressurization incidents in the fleet has indicated that some operators are setting the FLT ALT before takeoff to an intermediate altitude and then resetting the FLT ALT one or more times during climb until the final cruise altitude or flight level is reached. Although this method of operation also provides a safe and comfortable cabin altitude for the duration of the flight, there are some considerations which may make this method of operation less desirable:

- multiple adjustments of the FLT ALT unnecessarily increase crew workload during climb
 - intermediate FLT ALT settings are likely to result in higher cabin altitudes than if the final planned cruise flight altitude is selected. This is because the pressure schedule for lower altitudes uses lower differential pressure limits
 - if the flight crew does not reset the FLT ALT when appropriate, flying above the selected FLT ALT will drive the cabin towards maximum differential pressure. If maximum differential pressure is reached the cabin rate of climb will equal the airplane rate of climb..
-

Takeoff Briefing

The takeoff briefing should be accomplished as soon as practical so it does not interfere with the final takeoff preparations.

The takeoff briefing is a description of the departure flight path with emphasis on anticipated track and altitude restrictions. It assumes normal operating procedures are used. Therefore, it is not necessary to brief normal or standard takeoff procedures. Additional briefing items may be required when any elements of the takeoff and/or departure are different from those routinely used. These may include:

- adverse weather
 - adverse runway conditions
 - unique noise abatement requirements
 - dispatch using the minimum equipment list
 - special engine out departure procedures (if applicable)
 - any other situation where it is necessary to review or define crew responsibilities.
-

Push Back or Towing

[Appendix A.2.4](#)

Pushback and towing present serious hazards to ground personnel. There have been many accidents where personnel were run over by the airplane wheels during the pushback or towing process. Good communication between the flight deck and ground personnel is essential for a safe operation.

737 NG Flight Crew Training Manual

Pushback or towing involves three phases:

- positioning and connecting the tug and tow bar
- moving the airplane
- disconnecting the tow bar.

The headset operator, who is walking in the vicinity of the nose wheels, is usually the person injured or killed during pushback or towing accidents. Procedures that do not have personnel in the vicinity of the nose wheels help to reduce the possibility of these types of accidents.

Note: Pushback or tow out is normally accomplished with all hydraulic systems pressurized and the nose wheel steering locked out.

The captain should ensure that all appropriate checklists are completed prior to airplane movement. All passengers should be in their seats, all doors closed and all equipment away from the airplane. After the tow tractor and tow bar have been connected, obtain a pushback or towing clearance from ground control. Engine start may be accomplished during pushback or towing, or delayed until pushback or towing is completed. Ground personnel should be on headset to observe and communicate any possible safety hazards to the flight crew.

Note: The airplane should not be taxied away from a gate, or pushback position, unless the marshaller indicates the airplane is clear to taxi.

Taxi

Taxi General

Most reported runway incursions are attributed to a loss of situational awareness and not following ATC instructions. All pilots should be aware that incursions are a persistent problem and they must be proactive in preventing them during all ground operations.

The following guidelines are intended to enhance situational awareness and safety during ground operations:

Prior to Taxi

- review NOTAMS and current ATIS for any taxiway or runway closures, construction activity, or other airport risks that could affect the taxi route
- both pilots verify that the correct airplane position is in the FMC and the EFB airport moving map, (as installed), shows correct placement
- brief applicable items from airport diagrams and related charts to include the location of hold short lines
- ensure both crewmembers understand the expected taxi route
- write down the taxi clearance when received
- an airport diagram should be readily available to each crewmember during taxi.

During Taxi

- progressively follow taxi position on the airport diagram
- during low visibility conditions, call out all pertinent signs to verify position
- if unfamiliar with the airport, consider requesting a FOLLOW ME vehicle or progressive taxi instructions
- use standard radio phraseology
- read back all clearances. If any crewmember is in doubt regarding the clearance, verify taxi routing with the assigned clearance or request clarification. Stop the airplane if the clearance is in doubt
- if ground/obstruction clearance is in doubt, stop the airplane and verify clearance or obtain a wing-walker
- avoid distractions during critical taxi phases; plan ahead for checklist accomplishment and company communications
- consider delaying checklist accomplishment until stopped during low visibility operations
- do not allow ATC or anyone else to rush you
- verify the runway is clear (both directions) and clearance is received prior to entering a runway
- be constantly aware of the equipment, structures, and airplanes behind you when the engines are above idle thrust
- consider using the taxi light to visually indicate movement
- at night use all appropriate airplane lighting
- when entering any active runway ensure the exterior lights specified in the FCOM are illuminated.

Prior to Landing

- plan/brief the expected taxiway exit and route to parking.

After Landing

- ensure taxi instructions are clearly understood, especially when crossing closely spaced parallel runways
- delay non-essential radio or cabin communications until clear of all runways.

Flight Deck Perspective

There is a large area near the airplane where personnel, obstacles or guidelines on the ground cannot be seen, particularly in the oblique view across the flight deck. Special care must be exercised in the parking area and while taxiing. When parked, the pilot should rely on ground crew communications to a greater extent to ensure a safe, coordinated operation.

The pilot's seat should be adjusted for optimum eye position. The rudder pedals should be adjusted so that it is possible to apply maximum braking with full rudder deflection.

737 NG Flight Crew Training Manual

During taxiing, the pilot's heels should be on the floor, sliding the feet up on the rudder pedals only when required to apply brakes to slow the taxi speed, or when maneuvering in close quarters on the parking ramp.

Thrust Use

Thrust use during ground operation demands sound judgment and technique. Even at relatively low thrust the air blast effects from the large, high bypass engines can be destructive and cause injury. Airplane response to thrust lever movement is slow, particularly at high gross weights. Engine noise level in the flight deck is low and not indicative of thrust output. Idle thrust is adequate for taxiing under most conditions. A slightly higher thrust setting is required to begin taxiing. Allow time for airplane response before increasing thrust further.

The pilot taxiing should keep a hand on the thrust levers as much as possible during ground operations. This action ensures only intended movement of the thrust levers.

Excess thrust while taxiing may cause foreign objects to deflect into the lower aft fuselage, stabilizer, or elevators, especially when the engines are over an unimproved surface. Run-ups and taxi operations should only be conducted over well maintained paved surfaces and runways.

Backing with Reverse Thrust

Backing with reverse thrust is not recommended.

Taxi Speed and Braking

To begin taxi, release brakes, smoothly increase thrust to minimum required for the airplane to roll forward, and then reduce thrust as required to maintain normal taxi speed. A turn should normally not be started until sufficient forward speed has been attained to carry the airplane through the turn at idle thrust.

The airplane may appear to be moving slower than it actually is due to the flight deck height above the ground. Consequently, the tendency may be to taxi faster than desired. This is especially true during runway turnoff after landing. The ground speed display on the flight instruments may be used to determine actual taxi speed. The appropriate taxi speed depends on turn radius and surface condition.

Note: Some taxi speeds, usually between 10 and 20 knots, can cause an increase in airplane vibration, especially on rough taxiways. If this occurs, a slight increase or decrease in speed reduces or eliminates the vibration and increases passenger comfort.

Taxi speed should be closely monitored during taxi out, particularly when the active runway is some distance from the departure gate. Normal taxi speed is approximately 20 knots, adjusted for conditions. On long straight taxi routes, speeds up to 30 knots are acceptable, however at speeds greater than 20 knots use caution when using the nose wheel steering wheel to avoid overcontrolling the nose wheels. When approaching a turn, speed should be slowed to an appropriate speed for conditions. On a dry surface, for turn angles greater than those typically required for high speed runway turnoffs, use approximately 10 knots.

Note: High taxi speed combined with heavy gross weight and a long taxi distance can result in tire sidewall overheating.

Note: Taxiing long distances with continuous light brake pressure can cause the wheel fuse plugs to melt and deflate the tires.

Avoid prolonged brake application to control taxi speed as this causes high brake temperatures and increased wear of brakes. If taxi speed is too high, reduce speed with a steady brake application and then release the brakes to allow them to cool. Braking to approximately 10 knots and subsequent release of the brakes results in less heat build-up in the tires and brakes than when the brakes are constantly applied.

Under normal conditions, differential braking and braking while turning should be avoided. Allow for decreased braking effectiveness on slippery surfaces.

Avoid following other airplanes too closely. Jet blast is a major cause of foreign object damage.

During taxi, the momentary use of idle reverse thrust may be needed on slippery surfaces for airplane control. The use of reverse thrust above reverse idle is not recommended due to the possibility of foreign object damage and engine surge. Consider having the airplane towed rather than relying on the extended use of reverse thrust for airplane control.

Carbon Brake Life

For carbon brakes (as installed), brake wear is primarily dependent upon the number of brake applications. For example, one firm brake application causes less wear than several light applications. Continuous light applications of the brakes to keep the airplane from accelerating over a long period of time (riding the brakes) to maintain a constant taxi speed produces more wear than proper brake application.

During taxi, proper braking involves a steady application of the brakes to decelerate the airplane. Release the brakes as lower speed is achieved. After the airplane accelerates, repeat the braking sequence.

Antiskid Inoperative

With antiskid inoperative, tire damage or blowouts can occur if moderate to heavy braking is used. With this condition, it is recommended that taxi speed be adjusted to allow for very light braking.

Nose Wheel/Rudder Pedal Steering

The captain's position and some first officer's positions are equipped with a nose wheel steering wheel. The nose wheel steering wheel is used to turn the nose wheels through the full range of travel at low taxi speeds. Maintain positive pressure on the nose wheel steering wheel at all times during a turn to prevent the nose wheels from abruptly returning to center. Rudder pedal steering turns the nose wheels through a limited range of travel. Straight ahead steering and large radius turns may be accomplished with rudder pedal steering.

If nose wheel skidding or "scrubbing" occurs while turning, reduce steering angle and/or taxi speed. Avoid stopping the airplane in a turn as excessive thrust is required to start taxiing again.

Differential thrust may be required at high weights during tight turns. This should only be used as required to maintain the desired speed in the turn. After completing a turn, center the nose wheels and allow the airplane to roll straight ahead. This relieves stresses in the main and nose gear structure prior to stopping.

UNCONFIDENTIAL
IF PRINTED

Turning Radius and Gear Tracking

During all turning maneuvers, crews should be aware of their position relative to the nose and main landing gear. The pilot seat position is forward of the nose wheels and main gear as indicated in the tables in this chapter.

As the following diagram illustrates, while the airplane is turning, the main gear tracks inside the nose gear. The smaller the radius of the turn, the greater the distance that the main gear tracks inside the nose gear and the greater the need to steer the nose gear outside of the taxi path (oversteer).

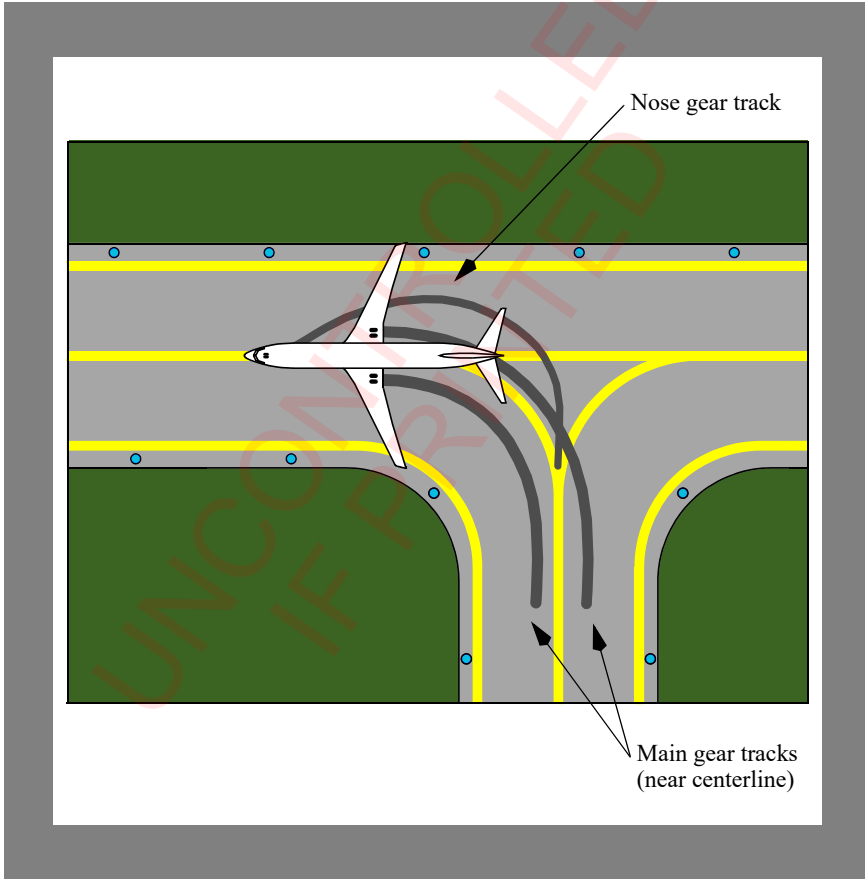

737 NG Flight Crew Training Manual

Visual Cues and Techniques for Turning while Taxiing

The following visual cues assume the pilot's seat is adjusted for optimum eye position. The following techniques also assume a typical taxiway width. Since there are many combinations of turn angles, taxiway widths, fillet sizes and taxiway surface conditions, pilot judgment must dictate the point of turn initiation and the amount of nose wheel steering wheel required for each turn. Except for turns less than approximately 30°, speed should be 10 knots or less prior to turn entry. For all turns, keep in mind the main gear are located behind the nose wheels, which causes them to track inside the nose wheels during turns. The pilot position being forward of the nose wheels and main gear is depicted in the table below.

Model	Pilot Seat Position (forward of nose gear) feet (meters)	Pilot Seat Position (forward of main gear) feet (meters)
737 - 600	5.25 (1.6)	42 (12.8)
737 - 700	5.25 (1.6)	47 (14.3)
737 - 800	5.25 (1.6)	56 (17.1)
737 - 900	5.25 (1.6)	62 (18.9)
737 - 900ER	5.25 (1.6)	62 (18.9)

Turns less than 90 degrees

During the turn, steer the nose wheels far enough beyond the centerline of the turn to keep the main gear close to the centerline.

Turns of 90 degrees or more

Initiate the turn as the intersecting taxiway centerline (or intended exit point) approaches approximately the center of the number 3 window. Initially use approximately full nose wheel steering wheel displacement. Adjust the steering wheel input as the airplane turns to keep the nose wheels outside of the taxiway centerline, near the outside radius of the turn. Nearing turn completion, when the main gear are clear of the inside radius, gradually release the steering wheel input as the airplane lines up with the intersecting taxiway centerline or intended taxi path.

Sharp Turns to a Narrow Taxiway

When making a sharp turn from a runway or a wide taxiway to a very narrow taxiway, consider displacing the aircraft to the far side of the runway or taxiway before initiating the turn. This allows more room for the inboard gear to stay on the taxi surface during the turn, and ensures a more accurate centerline alignment entering the narrow taxiway.

Note: Be aware of wing clearance, engine clearance, and the possibility of FOD ingestion on the side of the airplane that may be displaced over an unpaved surface.

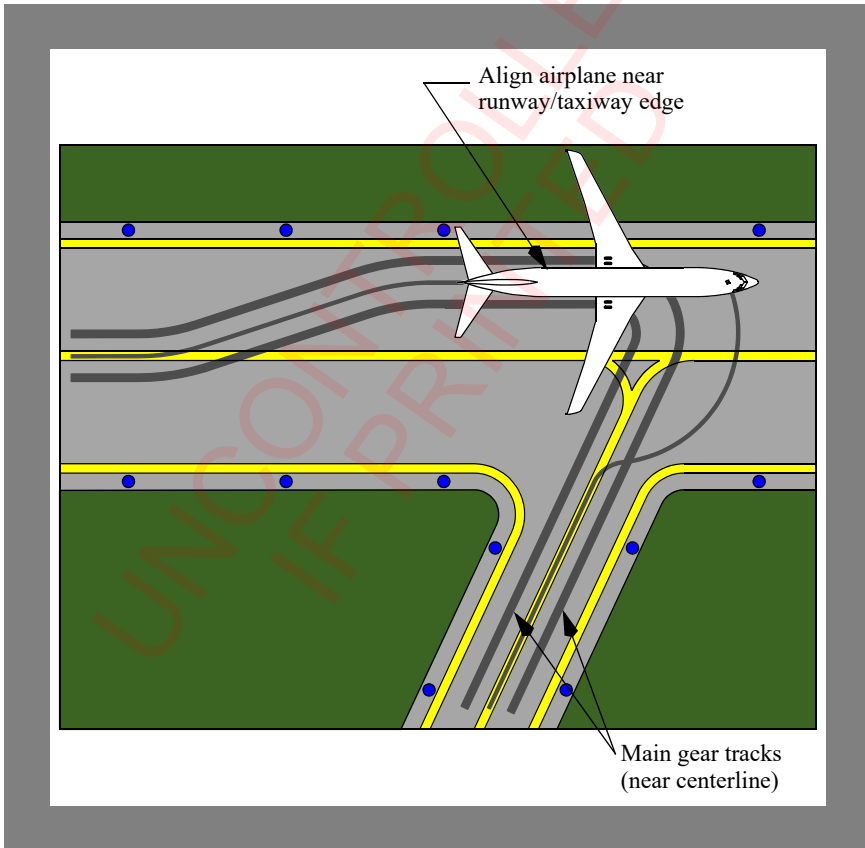

Turns of 180 Degrees

If the available taxi surface is narrow, coordination with external observers may be required to complete the operation safely. Reference special aerodrome operating instructions, if available. In some cases (e.g., heavy weight, pilot uncertainty of runway and/or taxiway pavement edge locations and related safety margins, nearby construction, vehicles, potential FOD damage, etc.), towing the airplane to the desired location may be the safest option.

If a minimum radius 180° turn is necessary, consider using the ground crew to monitor the wheel path and provide relevant information as the turn progresses. The ground crew should be warned of the risk associated with jet blast and position themselves to avoid the hazard. Also ensure that obstacle clearance requirements are met. Since more than idle thrust is required, the flight crew must be aware of buildings or other objects in the area being swept by jet blast during the turn.

Note: Monitor the nose gear track closely, because it leaves the pavement in the turn before the main gear.

Approach the edge of the taxi surface at a shallow angle until the outboard side of the main gear wheels are near the edge. The main gear are just inside the engine nacelles. Maneuver to keep the engine nacelles over the prepared surfaces.

Note: Painted runway markings are slippery when wet and may cause skidding of the nose gear during the turn.

Turning radius can be reduced by following a few specific taxi techniques. Taxi the airplane so that the main gear tires are close to the runway edge. This provides more runway surface to make the turn. Stop the airplane completely with the thrust at idle. Hold the nose wheel steering wheel to the maximum steering angle, release the brakes, then add thrust on the outboard engine. Only use the engine on the outboard side of the turn and maintain 5 to 10 knots during the turn to minimize turn radius. Light intermittent braking on the inside main gear helps decrease turn radius. Stopping the airplane in a turn is not recommended unless required to reduce the turn radius. As the airplane passes through 90° of turn, steer to place the main gear approximately on the runway centerline, then gradually reduce the nose wheel steering wheel input as required to align the airplane with the new direction of taxi.

This technique results in a low speed turn and less runway being used. It does not impose undue stress on the landing gear and tires provided the wheel brakes are not locked during the turn. If the nose gear skids, a good technique is to apply the inside wheel brake briefly and keep the airplane turning with asymmetric thrust as needed. If the turnaround is planned on a surface significantly greater in width than the minimum required, a turn entry could be made, without stopping, at 5-10 knots speed, using intermittent inside wheel braking and thrust as needed. Wind, slope, runway or taxiway surface conditions, and center of gravity may also affect the turning radius.

The following diagrams show suggested airplane ground tracks for minimum radius 180° turns with various runway turnaround configurations. These ground tracks provide the best maneuver capability while providing the maximum runway length available for takeoff at the completion of the turn. However, this type of maneuvering is normally not required unless operating on runways less than 148 feet (45m) in width.

UNCONTROLLED
IF PRINTED

737 NG Flight Crew Training Manual

Techniques when using a Circular Turnaround

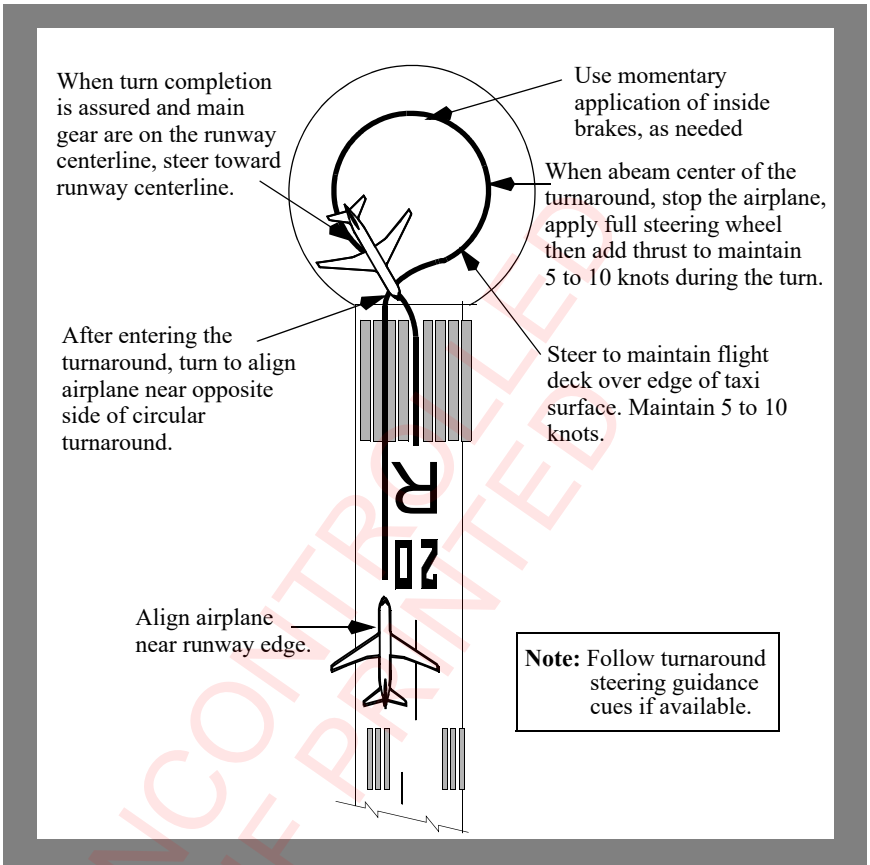

Techniques when using a Hammerhead Turnaround

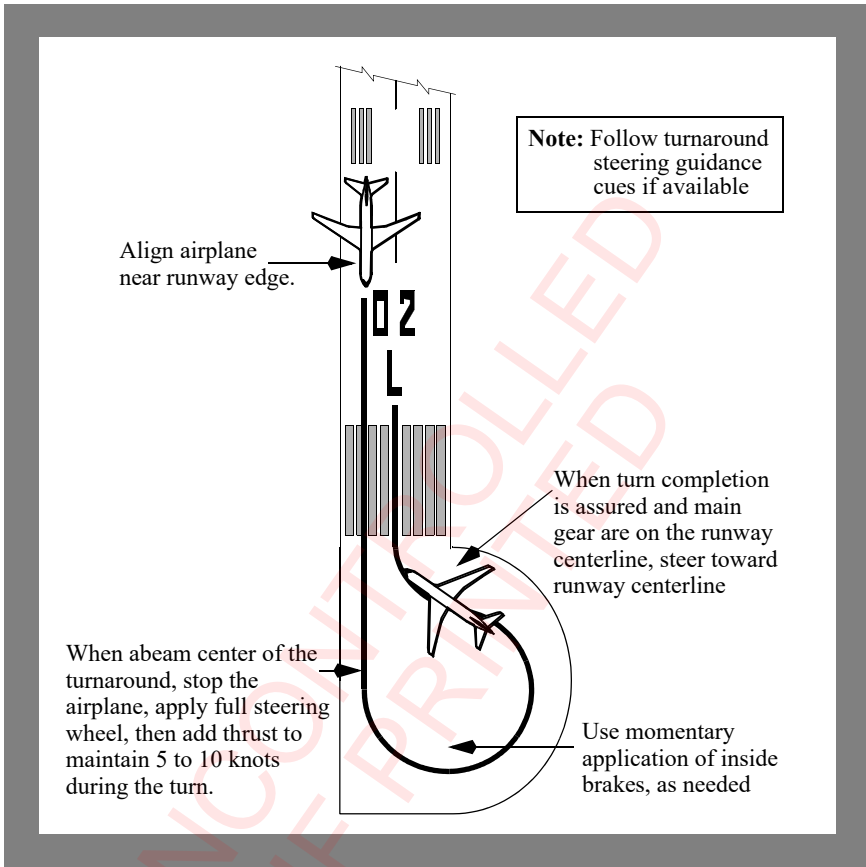

737 NG Flight Crew Training Manual

Techniques when using a Hammerhead Turnaround

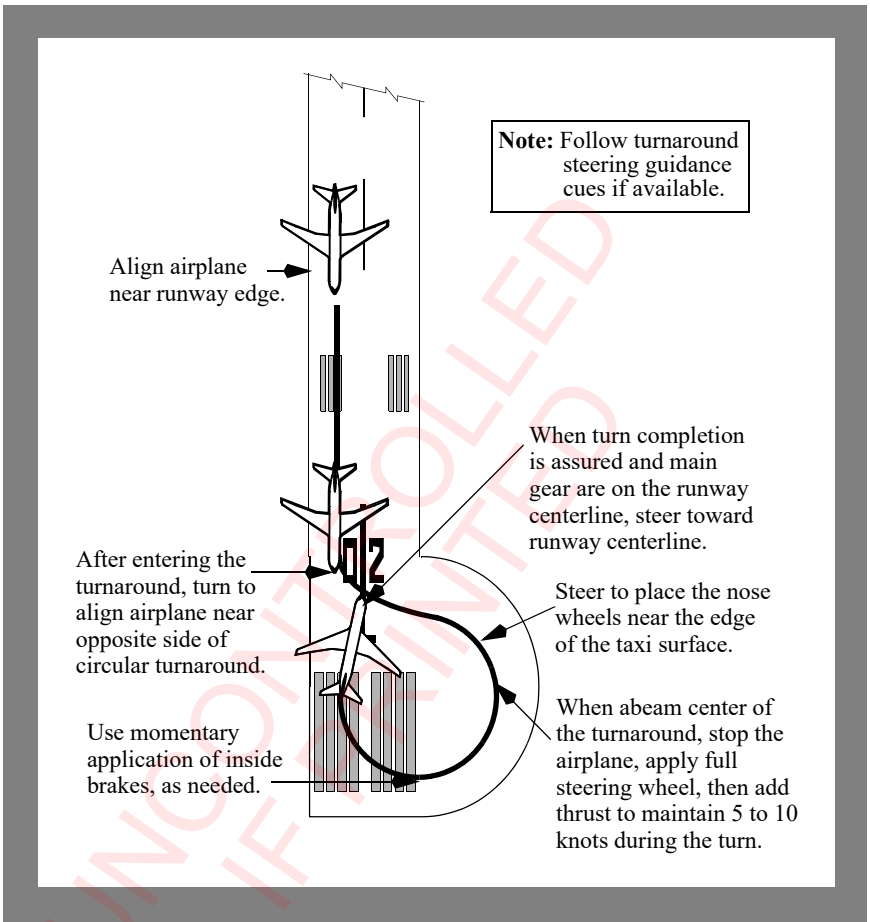

Taxi - Adverse Weather

Taxi under adverse weather conditions requires more awareness of surface conditions.

When taxiing on a slippery or contaminated surface, particularly with strong crosswinds, use reduced speeds. Use of differential engine thrust assists in maintaining airplane momentum through the turn. When nearing turn completion, placing both engines to idle thrust reduces the potential for nose gear skidding. Avoid using large nose wheel steering inputs to correct for skidding. Differential braking may be more effective than nose wheel steering on slippery or contaminated surfaces. If speed is excessive, reduce speed prior to initiating a turn.

Note: A slippery surface is any surface where the braking capability is less than that of a dry surface. Therefore, a surface is considered “slippery” when it is wet or contaminated with ice, standing water, slush, snow or any other deposit that results in reduced braking capability.

If icing conditions are present, use anti-ice as required by the FCOM. During prolonged ground operations, periodic engine run-ups should be accomplished to minimize ice build-up. These engine run-ups should be performed as defined in the FCOM.

Engine exhaust may form ice on the ramp and takeoff areas of the runway, or blow snow or slush which may freeze on airplane surfaces. If the taxi route is through slush or standing water in low temperatures, or if precipitation is falling with temperatures below freezing, taxi with flaps up. Extended or prolonged taxi times in heavy snow may necessitate de-icing prior to takeoff.

Low Visibility

Pilots need a working knowledge of airport surface lighting, markings, and signs for low visibility taxi operations. Understanding the functions and procedures to be used with stop bar lights, ILS critical area markings, holding points, and low visibility taxi routes is essential to conducting safe operations. Many airports have special procedures for low visibility operations. For example, airports operating under FAA criteria with takeoff and landing minimums below 1200 feet (350 m) RVR are required to have a low visibility taxi plan.

Flap Retraction after Landing

The Cold Weather Operations Supplementary Procedure defines how far the flaps may be retracted after landing in conditions where ice, snow, or slush may have contaminated the flap areas. If the flap areas are found to be contaminated, the flaps should not be retracted until maintenance has cleared the contaminants. Removal of the contaminants is a maintenance function addressed in the AMM.

Engine Out Taxi

[Appendix A.2.4](#)

Engine Out Taxi (EOT) operations have the potential to save fuel and to reduce carbon emissions.

During EOT operations, the crew's attention should be focused on taxiing the airplane. Distractions should be kept to a minimum.

Boeing does not publish specific procedures for EOT operations. Each operator develops EOT policies, procedures, and flight crew familiarization materials specific to their operation and in accordance with the requirements of their regulatory authorities.

UNCONTROLLED
IF PRINTED



Intentionally
Blank

UNCONTROLLED
IF PRINTED



Takeoff and Initial Climb

Chapter 3

Table of Contents

Section TOC

Preface 3.1

Takeoff. 3.1

 Takeoff Profile (FMC U10.7 and Earlier). 3.2

 Takeoff Profile Using VNAV (FMC U10.8 and Later) 3.3

 Takeoff - General 3.4

 Takeoff Flap Setting 3.4

 Takeoff Speeds 3.4

 Thrust Management. 3.5

 Initiating Takeoff Roll. 3.5

 Rotation and Liftoff - All Engines 3.8

 Effect of Rotation Speed and Pitch Rate on Liftoff 3.12

 Center-Of-Gravity Effects. 3.13

Crosswind Takeoff 3.14

 Takeoff Crosswind Guidelines 3.14

 Directional Control 3.16

 Rotation and Takeoff. 3.16

 Gusty Wind and Strong Crosswind Conditions 3.17

Reduced and Derated Takeoff Thrust 3.17

 Reduced Takeoff Thrust (ATM) 3.18

 Derated Takeoff Thrust (Fixed Derate). 3.18

 Combination ATM and Fixed Derate 3.19

 Thrust Control 3.19

Improved Climb Performance Takeoff 3.20

Low Visibility Takeoff 3.20

 Low Visibility Takeoff Using HUD 3.21

Adverse Runway Conditions 3.21

Takeoff Field Length - Title 14, CFR	3.22
Takeoff - Title 14, CFR	3.23
Rejected Takeoff Decision	3.24
Rejected Takeoff Maneuver	3.24
Go/Stop Decision Near V1	3.26
RTO Execution Operational Margins	3.27
Initial Climb - All Engines	3.30
Minimum Fuel Operation - Takeoff	3.30
Immediate Turn after Takeoff - All Engines	3.30
Roll Modes	3.31
Pitch Modes	3.31
Autopilot Engagement	3.32
Flap Retraction Schedule	3.32
Noise Abatement Takeoff	3.34
Takeoff - Engine Failure	3.35
General	3.35
Engine Failure Recognition	3.35
Rotation and Liftoff - One Engine Inoperative	3.35
Initial Climb - One Engine Inoperative	3.39
Immediate Turn after Takeoff - One Engine Inoperative	3.39
Autopilot Engagement - One Engine Inoperative	3.40
Flap Retraction - One Engine Inoperative	3.40
Flaps Up - One Engine Inoperative	3.41
Noise Abatement - One Engine Inoperative	3.41
Engine Failure During a Reduced Thrust (ATM) Takeoff	3.41
Engine Failure During a Derated Thrust (Fixed Derate) Takeoff	3.41
Engine Failure During a Combined ATM and Fixed Derate Takeoff	3.42



Preface

This chapter outlines the recommended operating practices and techniques for takeoff and initial climb. Engine failure during takeoff/initial climb is also addressed. The discussion portion of each illustration highlights important information.

The flight profile illustrations represent the recommended basic configuration during the accomplishment of the flight maneuvers, and provides a basis for standardization and crew coordination.

Takeoff

Normal takeoff procedures satisfy typical noise abatement requirements. Some airports may have special procedures which require modification of the takeoff profile.

UNCONTROLLED
IF PRINTED

Takeoff Profile (FMC U10.7 and Earlier)

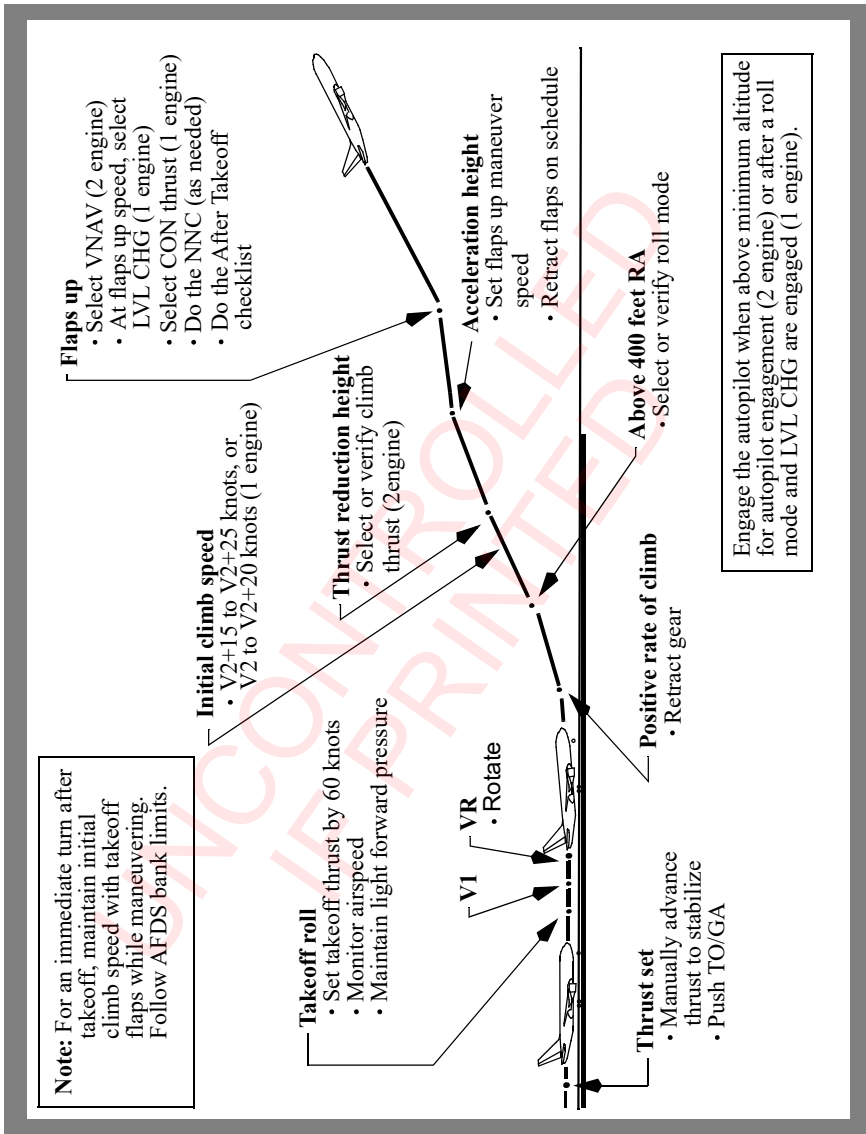

Takeoff Profile Using VNAV (FMC U10.8 and Later)

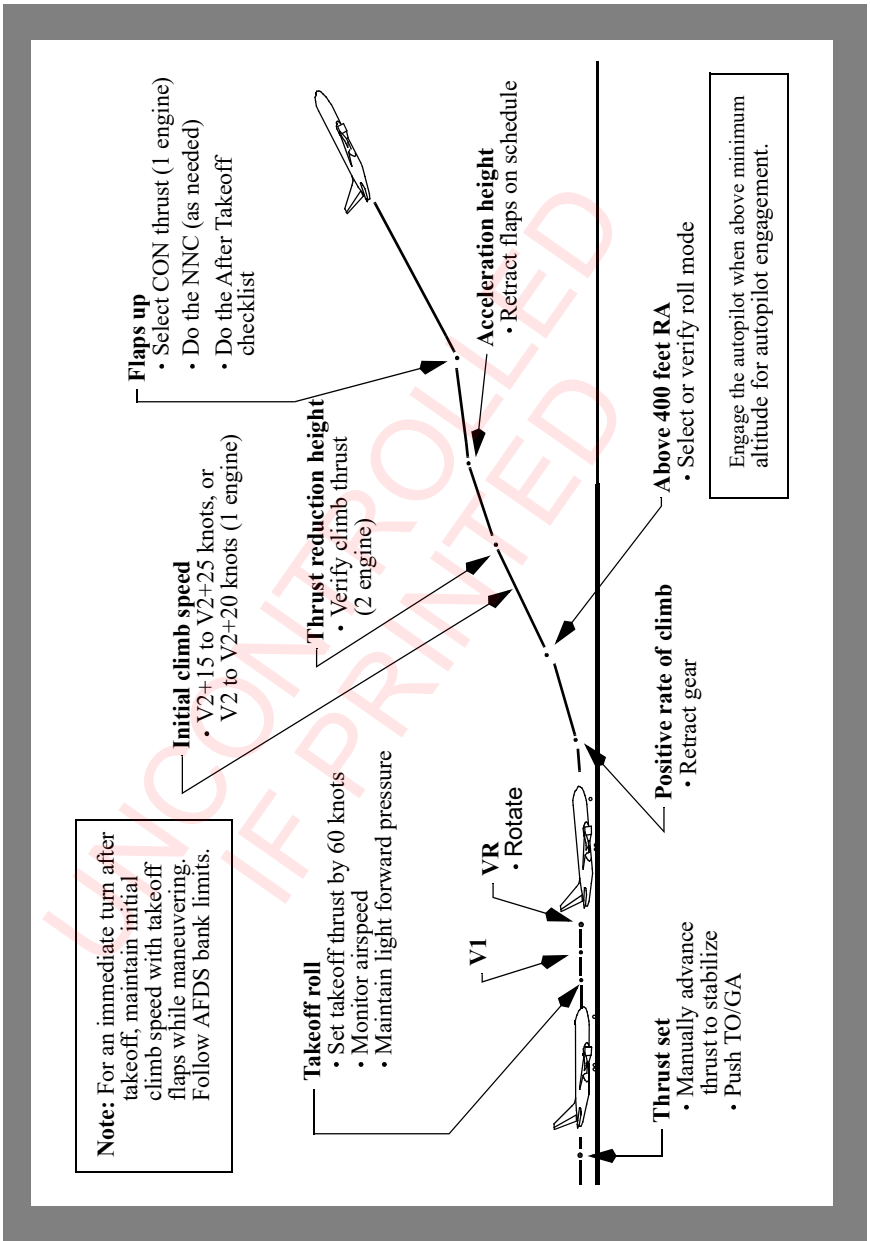

Takeoff - General

As part of the before start procedure, review the takeoff reference page to ensure the entries are correct and the preflight is complete. Ensure V2 is set on the MCP. The map display, map range and LEGS page sequence should be consistent with the departure procedure.

Review the LEGS page for any climb constraints. Ensure the CLB page contains the appropriate altitude and airspeed restrictions consistent with the departure procedure.

The PF normally displays the takeoff reference page on the CDU. Display of the takeoff reference page allows the crew to have immediate access to V-speeds during takeoff in the event that V-speeds are inadvertently removed from the airspeed display. After changes to the takeoff briefing have been updated during the Before Takeoff Procedure, the PF may elect to display the CLB page for takeoff. However, to reduce heads down activity, climb constraint modification immediately after takeoff should normally be accomplished on the mode control panel. Modify the CLB page when workload permits. The PM normally displays the LEGS page during takeoff and departure to allow timely route modification if necessary.

Takeoff Flap Setting

For takeoffs, when conditions permit, consider using larger flap settings to provide shorter takeoff distance. Larger flap settings also provide greater tail clearance. Refer to the Typical Takeoff Tail Clearance table in this chapter to determine minimum tail clearance for different takeoff flap settings.

Takeoff Speeds

Proper takeoff speeds (V1, VR, and V2) are based on takeoff weight, flaps setting, thrust rating and assumed temperature, ambient temperature, QNH, wind, runway surface condition, and performance options. The FCOM and FMC computed takeoff speeds (if enabled) are only valid for dispatch performance based on balanced field length, no improved climb, the most forward CG limit, and dry or wet runway.

The FCOM and FMC computed takeoff speeds do not consider runway length available, minimum engine-out climb gradient capability, or obstacle clearance requirement. The FCOM and FMC computed takeoff speeds can only be used when compliance of these requirements has been verified separately with a takeoff analysis (runway/airport analysis), another approved source, or by dispatch. The FCOM and FMC computed takeoff speeds are not valid for dispatch performance based on optimized V1 (unbalanced field length), Improved Climb, alternate forward CG limit, or contaminated or slippery runway.

Thrust Management

The EEC simplifies thrust management procedures. Having the EEC functioning does not relieve the pilots from monitoring the engine parameters and verifying proper thrust is obtained.

High thrust settings from jet engine blast over unpaved surfaces or thin asphalt pavement intended only to support occasional airplane movements can cause structural blast damage from loose rocks, dislodged asphalt pieces, and other foreign objects. Ensure run ups and takeoff operations are only conducted over well maintained paved surfaces and runways.

Initiating Takeoff Roll

Autothrottle and flight director use is recommended for all takeoffs. However, do not follow F/D commands until after liftoff.

A rolling takeoff is recommended for setting takeoff thrust. It expedites the takeoff and reduces the risk of foreign object damage or engine surge/stall due to a tailwind or crosswind. Flight test and analysis prove that the change in takeoff roll distance due to the rolling takeoff is negligible when compared to a standing takeoff.

Rolling takeoffs are accomplished in two ways:

- if cleared for takeoff before or while entering the runway, maintain normal taxi speed. When the airplane is aligned with the runway centerline ensure the nose wheel steering wheel is released and apply takeoff thrust by advancing the thrust levers to just above idle (40%N1). Allow the engines to stabilize momentarily then promptly advance the thrust levers to takeoff thrust (autothrottle TO/GA). There is no need to stop the airplane before increasing thrust.
- if holding in position on the runway, ensure the nose wheel steering wheel is released, release brakes, then apply takeoff thrust as described above.

Note: Brakes are not normally held with thrust above idle unless a static run-up in icing conditions is required.

A standing takeoff may be accomplished by holding the brakes until the engines are stabilized, ensure the nose wheel steering wheel is released, then release the brakes and promptly advance the thrust levers to takeoff thrust (autothrottle TO/GA).



737 NG Flight Crew Training Manual

Allowing the engines to stabilize provides uniform engine acceleration to takeoff thrust and minimizes directional control problems. This is particularly important if crosswinds exist or the runway surface is slippery. The exact initial setting is not as important as setting symmetrical thrust. If thrust is to be set manually, smoothly advance thrust levers toward takeoff thrust.

Note: Allowing the engines to stabilize for more than approximately 2 seconds before advancing thrust levers to takeoff thrust may adversely affect takeoff distance.

Ensure the target N1 is set by 60 knots. Minor increases in thrust may be made immediately after 60 knots to reach the target N1. After takeoff thrust is set, a small deviation in N1 between the engines should not warrant a decision to reject the takeoff unless this deviation is accompanied by a more serious event. (Refer to the QRH, Maneuvers Chapter, Rejected Takeoff, for criteria.) Due to variations in thrust settings, runway conditions, etc., it is not practical to specify a precise tolerance for N1 deviation between the engines.

Limited circumstances such as inoperative rudder pedal steering may require the use of the nose wheel steering wheel at low speeds during takeoff when the rudder is not effective. Reference the airplane Dispatch Deviations Guide (DDG) for more information concerning operation with rudder pedal steering inoperative.

If an engine exceedance occurs after thrust is set and the decision is made to continue the takeoff, do not retard the thrust lever in an attempt to control the exceedance. Retarding the thrust levers after thrust is set invalidates takeoff performance. When the PF judges that altitude (minimum 400 feet AGL) and airspeed are acceptable, the thrust lever should be retarded until the exceedance is within limits and the appropriate NNC accomplished.

Light forward pressure is held on the control column. Keep the airplane on centerline with rudder pedal steering and rudder. The rudder becomes effective between 40 and 60 knots. Maximum nose wheel steering effectiveness is available when above taxi speeds by using rudder pedal steering.

Regardless of which pilot is making the takeoff, the captain should keep one hand on the thrust levers until V1 in order to respond quickly to a rejected takeoff condition. After V1, the captain's hand should be removed from the thrust levers.

The PM should monitor engine instruments and airspeed indications during the takeoff roll and announce any abnormalities. The PM should announce passing 80 knots and the PF should verify that his airspeed indicator is in agreement.

737 NG Flight Crew Training Manual

A pitot system blocked by protective covers or foreign objects can result in no airspeed indication, or airspeed indications that vary between instruments. It is important that aircrews ensure airspeed indicators are functioning and reasonable at the 80 knot callout. If the accuracy of either primary airspeed indication is in question, reference the standby airspeed indicator. Another source of speed information is the ground speed indication. Early recognition of a malfunction is important in making a sound go/stop decision. Refer to the Airspeed Unreliable section in Chapter 8 for an expanded discussion of this subject.

The PM should verify that takeoff thrust has been set and the throttle hold mode (THR HLD) is engaged. A momentary autothrottle overshoot of 4% N1 may occur but thrust should stabilize at +/- 2% N1, after THR HLD. Thrust should be adjusted by the PM, if required, to - 0% + 1% target N1. Once THR HLD annunciates, the autothrottle cannot change thrust lever position, but thrust levers can be positioned manually. The THR HLD mode remains engaged until another thrust mode is selected.

Note: Takeoff into headwind of 20 knots or greater may result in THR HLD before the autothrottle can make final thrust adjustments.

The THR HLD mode protects against thrust lever movement if a system fault occurs. Lack of the THR HLD annunciation means the protective feature may not be active. If THR HLD annunciation does not appear, no crew action is required unless a subsequent system fault causes unwanted thrust lever movement. As with any autothrottle malfunction, the autothrottle should then be disconnected and desired thrust set manually.

Rotation and Liftoff - All Engines

Takeoff speeds are established based on minimum control speed, stall speed, and tail clearance margins. Shorter-bodied airplanes are normally governed by stall speed margin while longer-bodied airplanes are normally limited by tail clearance margin. When a smooth continuous rotation is initiated at VR, tail clearance margin is assured because computed takeoff speeds depicted in the PI Chapter of the FCOM, airport analysis, or FMC, are developed to provide adequate tail clearance.

Above 80 knots, relax the forward control column pressure to the neutral position. For optimum takeoff and initial climb performance, initiate a smooth continuous rotation at VR toward 15° of pitch attitude. However, takeoffs at low thrust setting (low excess energy) will result in a lower initial pitch attitude target to achieve the desired climb speed.

The use of stabilizer trim during rotation is not recommended. After liftoff, use the attitude indicator, or indications on the PFD or HUD (HUD equipped airplanes), as the primary pitch reference. The flight director, in conjunction with indicated airspeed and other flight instruments is used to maintain the proper vertical flight path.

Note: The flight director pitch command is not used for rotation.

With a consistent rotation technique, where the pilot uses approximately equal control forces and similar visual cues, the resultant rotation rate differs slightly depending upon airplane body length.

Note: Do not adjust takeoff speeds or control forces to compensate for increased body length.

Using the technique above, resultant rotation rates vary from 2° to 3° per second with rates being lowest on longer airplanes. Liftoff attitude is achieved in approximately 3 to 4 seconds depending on airplane weight and thrust setting.

Typical Rotation, All Engines

The following figure shows typical rotation with all engines operating.

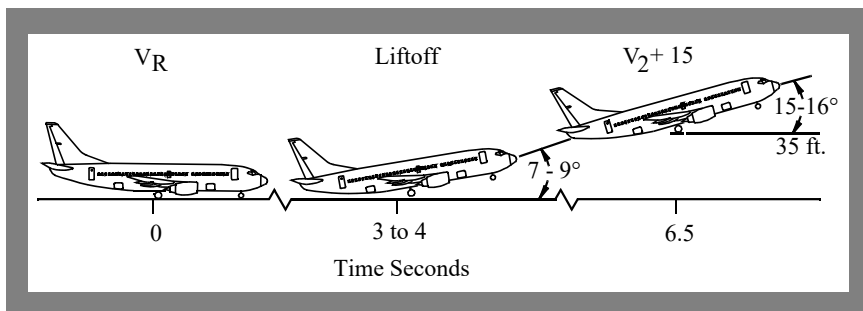

737 NG Flight Crew Training Manual

Retract the landing gear after a positive rate of climb is indicated on the altimeter.

Retract flaps in accordance with the technique described in this chapter.

Note: When operating at low gross weights, takeoff with less than full rated thrust will aid in aircraft directional control in the event of an engine failure. The rotation should be accomplished at the normal rate, but the pitch attitudes during the transition to initial climb may be higher than normal.

UNCONTROLLED
IF PRINTED

Typical Takeoff Tail Clearance

The following diagram and table show the effect of flap position on liftoff pitch attitude and minimum tail clearance during takeoff. Additionally, the last column shows the pitch attitude for tail contact with wheels on the runway and landing gear struts extended. For a discussion of tail strike procedures see Chapter 8 and the Tail Strike NNC.

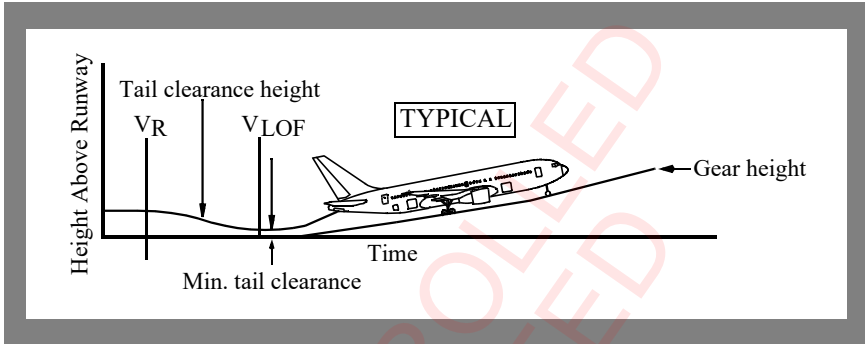

Model	Flaps	Liftoff Attitude (degrees)	Minimum Tail Clearance inches (cm)	Tail Strike Pitch Attitude (degrees)
737-600	1	9.0	28 (71)	16.2
	5	9.0	28 (71)	
	10	8.8	29 (73)	
	15	8.7	30 (76)	
	25	8.6	32 (81)	
737-700	1	9.1	29 (73)	14.7
	5	9.1	29 (73)	
	10	8.9	30 (76)	
	15	8.7	31 (79)	
	25	8.5	32 (81)	
737-800	1	8.5	13 (33)	11.0
	5	8.0	20 (51)	
	10	7.6	23 (58)	
	15	7.3	25 (64)	
	25	7.0	29 (73)	

737 NG Flight Crew Training Manual

Model	Flaps	Liftoff Attitude (degrees)	Minimum Tail Clearance inches (cm)	Tail Strike Pitch Attitude (degrees)
737-900	1	8.0	13 (33)	10.0
	5	7.6	19 (49)	
	10	7.4	22 (56)	
	15	7.1	24 (61)	
	25	7.0	25 (64)	
737-900ER	1	8.0	13 (33)	10.0
	5	7.6	19 (49)	
	10	7.1	24 (61)	
	15	7.0	25 (64)	
	25	6.8	27 (69)	

Note: Flaps 1 and 5 (-800/900/900ER) takeoffs have the least clearance. Consider using a larger flap setting for takeoffs at light gross weights. Because of the short fuselage, aft fuselage contact is unlikely in the 737-600.

UNCONFIDENTIAL

Effect of Rotation Speed and Pitch Rate on Liftoff

Takeoff and initial climb performance depend on rotating at the correct airspeed and proper rate to the rotation target attitude. Early or rapid rotation may cause a tail strike. Late, slow, or under-rotation increases takeoff ground roll. Any improper rotation decreases initial climb flight path.

An improper rotation can have an effect on the command speed after liftoff. If the rotation is delayed beyond $V_2 + 20$ knots, the speed commanded by the flight director is rotation speed up to a maximum of $V_2 + 25$ knots. An earlier liftoff does not affect the commanded initial climb speed, however, either case degrades overall takeoff performance.

The following diagram shows how slow or under rotation during takeoff increases the distance to a height of 35 feet compared to a normal rotation.

Slow or Under Rotation (Typical)

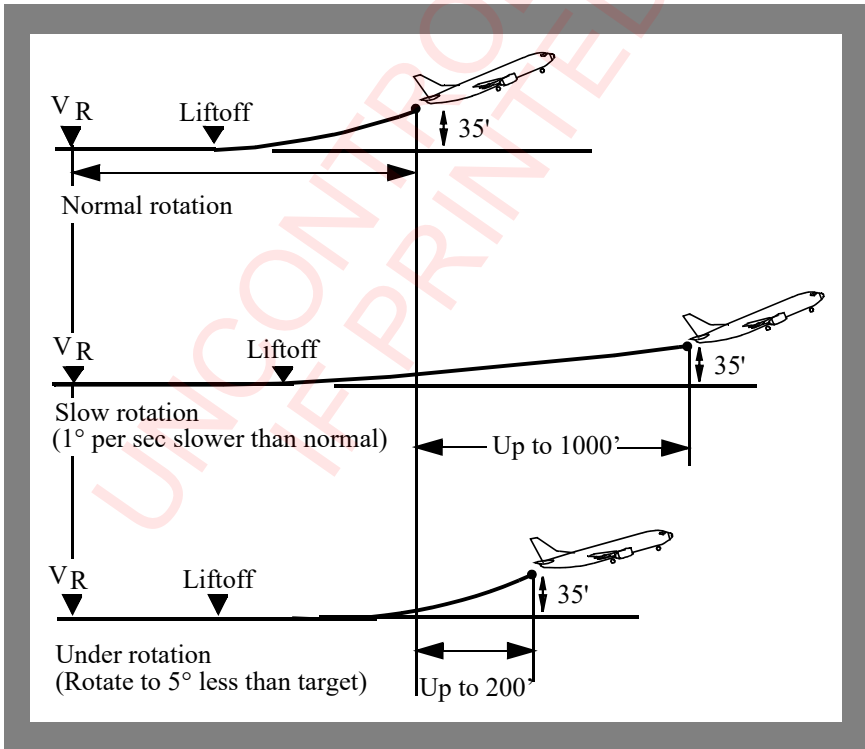

Center-Of-Gravity Effects

When taking off at light weight and with an aft CG, the combination of full thrust, rapid thrust application, and sudden brake release may tend to pitch the nose up, reducing nosewheel steering effectiveness. With CG at or near the aft limit, maintain forward pressure on the control column until 80 knots to increase nosewheel steering effectiveness. Above 80 knots, relax the forward control column pressure to the neutral position. At light weight and aft CG, use of reduced thrust and rolling takeoff technique is recommended whenever possible. The rudder becomes effective between 40 and 60 knots.

Operation with Alternate Forward Center of Gravity Limit for Takeoff

Takeoff performance is based on the forward CG limitations as defined in the AFM. However, takeoff performance can be improved by taking credit for an alternate (further aft) forward CG limit if shown in the AFM. Use of this data provides higher performance-limited takeoff weights than the basic AFM performance data.

Typically alternate forward CG is used to increase performance-limited takeoff weight for field length, climb or obstacle limited departures. Another potential benefit of alternate forward CG is to allow greater thrust reduction which increases engine reliability and reduces engine maintenance costs. However, this improved performance capability is only available if the operator has the certified data in their AFM and has approval from their regulatory agency to operate the airplane at an alternate forward CG limit.

A more aft CG increases the lift available at a given angle of attack due to the reduction in nose up trim required from the horizontal stabilizer. This allows VR and V2 to be reduced, which in turn reduces the field length required for takeoff. Reduction in field length required can also permit an increased field length limited weight. In most instances this reduction in nose up trim also results in a decrease in drag which improves the airplane's climb capability.

Note: The FMC calculated takeoff speeds and QRH takeoff speeds are not valid for operations using alternate forward CG. Takeoff speeds must be calculated using alternate forward CG performance data normally provided by dispatch or flight operations.

Crosswind Takeoff

The crosswind guidelines shown below were derived through flight test data, engineering analysis, and flight simulator evaluations. These crosswind guidelines are based on steady wind (no gust) conditions and include all engines operating and engine inoperative. Gust effects were evaluated and tend to increase pilot workload without significantly affecting the recommended guidelines. The crosswind guidelines presented in the table below should be considered the maximum recommended crosswinds, including gusts, unless an operator has provided different crosswind and gust guidance.

Note: Engine surge can occur with a strong crosswind or tailwind component if takeoff thrust is set before brake release. Therefore, the rolling takeoff procedure is strongly advised when crosswinds exceed 20 knots or tailwinds exceed 10 knots.

Takeoff Crosswind Guidelines

Appendix A.2.5

Crosswind guidelines are not considered limitations. Crosswind guidelines are provided to assist operators in establishing their own crosswind policies.

Takeoff crosswind guideline considerations:

- takeoff crosswind guidelines are based on the most adverse airplane loading (light weight and aft center of gravity), and assume an engine out RTO and proper pilot technique
- on slippery runways, crosswind guidelines are a function of runway surface condition
- takeoff on untreated snow or ice should only be attempted when no melting is present
- winds measured at 33 feet (10 m) tower height and apply for runways 148 feet (45m) or greater in width.

Takeoff Crosswind Guidelines - Non-TALPA

Runway Condition	Crosswind Component (knots)
	without / with winglets
Dry	36 / 34
Wet	25
Standing Water/Slush	15
Snow - No Melting	25
Ice - No Melting	15

737 NG Flight Crew Training Manual
Runway Condition Assessment - TALPA

The following table is an abbreviated version of the Matrix for runway condition assessment in terms of the Takeoff and Landing Performance Assessment (TALPA) categories contained in AC 25-32. The runway condition descriptions and codes are aligned with control/braking action reports.

Runway Condition Assessment		
Runway Condition Description	Runway Condition Code	Control / Braking Action
<ul style="list-style-type: none"> • Dry 	6	---
<ul style="list-style-type: none"> • Frost • Wet (includes damp and 1/8" (3mm) depth or less of water) <li style="padding-left: 40px;">1/8" (3mm) depth or less of: • Slush • Dry Snow • Wet Snow 	5	Good
<p style="text-align: center;">-15°C and colder OAT:</p> <ul style="list-style-type: none"> • Compacted Snow 	4	Good to Medium
<ul style="list-style-type: none"> • Slippery when wet (wet runway) • Dry or Wet Snow (any depth) over Compacted Snow <li style="padding-left: 40px;">Greater than 1/8" (3mm) depth: • Dry Snow • Wet Snow <li style="padding-left: 40px;">Warmer than -15°C OAT: • Compacted snow 	3	Medium
<p style="text-align: center;">Greater than 1/8" (3mm) depth:</p> <ul style="list-style-type: none"> • Water • Slush 	2	Medium to Poor
<ul style="list-style-type: none"> • Ice 	1	Poor
<ul style="list-style-type: none"> • Wet Ice • Water on top of Compacted Snow • Dry Snow or Wet Snow over Ice 	0	Nil



Takeoff Crosswind Guidelines - TALPA

The crosswind guideline is determined by entering the table below with Runway Condition Code or Control/Braking Action.

Runway Condition Code	Control / Braking Action	Crosswind Component (knots)
6	---	36 / 34 with winglets
5	Good	25
4	Good to Medium	22
3	Medium	20
2	Medium to Poor	15
1	Poor	13
0	Nil	---

Directional Control

Initial runway alignment and smooth symmetrical thrust application result in good crosswind control capability during takeoff. Light forward pressure on the control column during the initial phase of the takeoff roll (below approximately 80 knots) increases nose wheel steering effectiveness. Any deviation from the centerline during thrust application should be countered with immediate, smooth, and positive control inputs. Smooth rudder and control wheel inputs result in a normal takeoff with no overcontrolling. Large control wheel inputs can have an adverse effect on directional control near V₁(MCG) due to the additional drag of the extended spoilers.

Note: With wet or slippery runway conditions, the PM should give special attention to ensuring the engines have symmetrically balanced thrust indications.

Rotation and Takeoff

Begin the takeoff roll with the control wheel approximately centered. Throughout the takeoff roll, gradually increase control wheel displacement into the wind only enough to maintain approximately wings level.

Note: Excessive control wheel displacement during rotation and liftoff increases spoiler deployment. As spoiler deployment increases, drag increases and lift is reduced which results in reduced tail clearance, a longer takeoff roll, and slower airplane acceleration.

737 NG Flight Crew Training Manual

At liftoff, the airplane is in a sideslip with crossed controls. A slow, smooth recovery from this sideslip is accomplished by slowly neutralizing the control wheel and rudder pedals after liftoff.

Gusty Wind and Strong Crosswind Conditions

For takeoff in gusty or strong crosswind conditions, use of a higher thrust setting than the minimum required is recommended. When the prevailing wind is at or near 90° to the runway, the possibility of wind shifts resulting in gusty tailwind components during rotation or liftoff increases. During this condition, consider the use of thrust settings close to or at maximum takeoff thrust. The use of a higher takeoff thrust setting reduces the required runway length and minimizes the airplane exposure to gusty conditions during rotation, liftoff, and initial climb.

To increase tail clearance during strong crosswind conditions, consider using a higher VR if takeoff performance permits. This can be done by:

- increasing VR speed to the performance limited gross weight rotation speed, not to exceed actual gross weight VR + 20 knots. Set V speeds for the actual gross weight. Rotate at the adjusted (higher) rotation speed. This increased rotation speed results in an increased stall margin, and meets takeoff performance requirements.

Avoid rotation during a gust. If a gust is experienced near VR, as indicated by stagnant airspeed or rapid airspeed acceleration, momentarily delay rotation. This slight delay allows the airplane additional time to accelerate through the gust and the resulting additional airspeed improves the tail clearance margin. Do not rotate early or use a higher than normal rotation rate in an attempt to clear the ground and reduce the gust effect because this reduces tail clearance margins. Limit control wheel input to that required to keep the wings level. Use of excessive control wheel increases spoiler deployment which has the effect of reducing tail clearance. All of these factors provide maximum energy to accelerate through gusts while maintaining tail clearance margins at liftoff. The airplane is in a sideslip with crossed controls at this point. A slow, smooth recovery from this sideslip is accomplished after liftoff by slowly neutralizing the control wheel and rudder pedals.

Reduced and Derated Takeoff Thrust

Normally, takeoffs are conducted with less than full rated takeoff thrust whenever performance capabilities permit. Lower takeoff thrust reduces EGT, improves engine reliability, and extends engine life.



Takeoff thrust reduction can be achieved using reduced takeoff thrust (Assumed Temperature Method or ATM), derated takeoff thrust (fixed derate), or a combination of these two methods. Regardless of the method, takeoff speeds based on the selected rating (full rated or fixed derate) and the selected assumed temperature should be used. These takeoff speeds may be obtained from the takeoff analysis (runway/airport analysis) or another approved source. Takeoff with less than full rated takeoff thrust using any of these methods complies with all regulatory takeoff performance requirements.

Note: Takeoff with full rated takeoff thrust is recommended if windshear conditions are suspected, unless the use of a fixed derate is required to meet a dispatch performance requirement.

Reduced Takeoff Thrust (ATM)

Reduced takeoff thrust (ATM) is a takeoff thrust level less than the full rated takeoff thrust. Reduced takeoff thrust is achieved by selecting an assumed temperature higher than the actual ambient temperature.

When using ATM, the takeoff thrust setting is not considered a takeoff operating limit since minimum control speeds (VMCG and VMCA) are based on the full rated takeoff thrust. At any time during takeoff, thrust levers may be advanced to the full rated takeoff thrust.

Note: Reduced takeoff thrust (ATM) may be used for takeoff on a wet runway if approved takeoff performance data for a wet runway is used. However, reduced takeoff thrust (ATM) is not permitted for takeoff on a runway contaminated with standing water, slush, snow, or ice.

Note: For reduced takeoff thrust (ATM) takeoffs, slightly more back pressure may be needed during rotation and initial climb.

Derated Takeoff Thrust (Fixed Derate)

Derated takeoff thrust (fixed derate) is a certified takeoff thrust rating lower than full rated takeoff thrust. In order to use derated takeoff thrust, takeoff performance data for the specific fixed derate level is required. Derated takeoff thrust is obtained by selection of a fixed takeoff derate in the FMC.

737 NG Flight Crew Training Manual

When using derated takeoff thrust, the takeoff thrust setting is considered a takeoff operating limit since minimum control speeds (VMCG and VMCA) and stabilizer trim setting are based on the derated takeoff thrust. Thrust levers should not be advanced unless conditions are encountered during the takeoff where additional thrust is needed on both engines, such as a windshear condition.

Note: If an engine failure occurs during takeoff, any thrust increase could result in loss of directional control. See the section titled “Engine Failure during a Derated Thrust (Fixed Derate) Takeoff” later in this chapter.

Note: Derated takeoff thrust (fixed derate) may be used for takeoff on a wet runway and on a runway contaminated with standing water, slush, snow, or ice.

Derated takeoff thrust (fixed derate) may permit a higher takeoff weight when performance is limited by VMCG, such as on a runway contaminated with standing water, slush, snow, or ice. This is because derated takeoff thrust allows a lower VMCG.

Derated takeoff thrust (fixed derate) may permit a lower takeoff weight when takeoff weight is limited by the Minimum Takeoff Weight requirement.

Combination ATM and Fixed Derate

Note: All limitations and restrictions for reduced takeoff thrust (ATM) and derated takeoff thrust (fixed derate) must be observed.

Reduced takeoff thrust (ATM) and derated takeoff thrust (fixed derate) may be combined by first selecting a fixed derate and then an assumed temperature higher than the actual ambient temperature. Thrust levers should not be advanced unless conditions are encountered during the takeoff where additional thrust is needed on both engines, such as a windshear condition.

Note: If an engine failure occurs during takeoff, any thrust increase beyond the fixed derate limit could result in loss of directional control. See the section titled “Engine Failure during a Combined ATM and Fixed Derate Takeoff” later in this chapter.

Thrust Control

When conducting a reduced thrust (ATM) takeoff, if more thrust is needed (up to full rated thrust) when thrust is in THR HLD mode, thrust levers must be advanced manually. If conditions are encountered during the takeoff where additional thrust is needed, such as a windshear condition, the crew should not hesitate to manually advance thrust levers to full rated thrust.

When conducting a derated thrust (fixed derate) takeoff or a takeoff with a combination ATM and fixed derate, takeoff speeds consider VMCG and VMCA only at the fixed derate level of thrust. Thrust levers should not be advanced beyond the fixed derate limit unless conditions are encountered during the takeoff where additional thrust is needed on both engines, such as a windshear condition.

Note: If an engine failure occurs during takeoff, any thrust increase beyond the fixed derate limit could result in loss of directional control.

When combining a high level of derate with a high assumed temperature, or if a climb thrust rating higher than the automatically selected climb thrust rating is selected, it is possible that the climb thrust may be higher than the takeoff thrust. In such case, thrust levers will advance forward upon reaching thrust reduction altitude.

If more thrust is needed (up to full rated thrust) when THR HLD mode is displayed, the thrust levers must be manually advanced. When the airplane is below 800 feet RA, full GA N1 can be determined by pushing a TO/GA switch a second time. This will set the reference N1 bugs for full GA thrust.

When the airplane is above 800 feet RA, pushing a TO/GA switch advances the thrust levers to full GA thrust.

Improved Climb Performance Takeoff

When not field length limited, an increased climb limit weight is achieved by using the excess field length to accelerate to higher takeoff and climb speeds. This improves the climb gradient, thereby raising the climb and obstacle limited weights. V1, VR and V2 are increased and must be obtained from dispatch or by airport analysis.

Low Visibility Takeoff

Appendix A.2.5

Low visibility takeoff operations, below landing minima, may require a takeoff alternate. When selecting a takeoff alternate, consideration should be given to unexpected events such as an engine failure or other non-normal situation that could affect landing minima at the takeoff alternate. Operators, who have authorization for engine inoperative Category II/III operations, may be authorized lower alternate minima.

With proper crew training and appropriate runway lighting, takeoffs with visibility as low as 500ft/150m RVR may be authorized (FAA). With takeoff guidance systems and centerline lighting that meets FAA or International Civil Aviation Organization (ICAO) criteria for Category III operations, takeoffs with visibility as low as 300ft/75m RVR may be authorized. Regulatory agencies may apply takeoff crosswind limits specifically for low visibility takeoffs.

Boeing Proprietary. Copyright © Boeing. May be subject to export restrictions under EAR. See title page for details.

737 NG Flight Crew Training Manual

All RVR readings must be equal to or greater than required takeoff minima. If the touchdown or rollout RVR system is inoperative, the mid RVR may be substituted for the inoperative system. When the touchdown zone RVR is inoperative, pilot estimation of RVR may be authorized by regulatory agencies.

Low Visibility Takeoff Using HUD

During takeoff, normal procedures including callouts are used. Once the airplane is aligned with the runway, verify display of the ground roll guidance cue on the HUD. Also, adjust the combiner brightness to allow both runway markings and symbology to be viewed clearly. The PF performs the takeoff roll by using visual cues and HUD symbology. The HUD guidance provides steering commands to maintain the centerline, however the runway markings and runway lighting are the primary indication of centerline tracking.

Initiate a smooth continuous rotation to place the airplane pitch reference symbol over the target pitch line. Once the airplane pitch is stabilized, transition to the flight path vector and guidance cue. When large dynamic control inputs are required such as during takeoff rotation or go-around, turbulence and crosswinds often magnify the movement of the flight path vector. Aggressive maneuvering can result in an overshoot of the flight path vector and guidance cue. Whenever large dynamic control inputs are made, the pilot should continue the normal flight instrument scan and not focus attention exclusively on the HUD symbology.

The PM must be aware that during the takeoff the PF's attention is devoted almost exclusively to outside and HUD cues. This requires that the PM's attention be devoted to head down instruments more than during the normal takeoff roll when the HUD is not in use.

Adverse Runway Conditions[Appendix A.2.6](#)

Slush, standing water, or deep snow reduces the airplane takeoff performance because of increased rolling resistance and reduced tire-to-ground friction. In addition to performance considerations, slush or standing water may cause damage to the airplane.

Most operators specify weight reductions to the AFM field length or obstacle limited takeoff weight based on the depth of the slush or standing water, wet snow, or dry snow, and a maximum depth beyond which a takeoff should not be attempted. Reference the Takeoff - Wet or Contaminated Runway Conditions Supplementary Procedure in the FCOM for more information including recommended maximum depth of runway contaminants for takeoff.

A slippery runway (wet, compact snow, ice) also increases stopping distance during a rejected takeoff. Takeoff performance and critical takeoff data are adjusted to fit the existing conditions. Check the airport analysis or the PI Chapter of the FCOM for takeoff performance changes with adverse runway conditions.

Note: If there is an element of uncertainty concerning the safety of an operation with adverse runway conditions, do not takeoff until the element of uncertainty is removed.

During wet runway or slippery conditions, the PM must give special attention to ensuring that the thrust on the engines advances symmetrically. Any tendency to deviate from the runway centerline must immediately be countered with steering action and, if required, slight differential thrust.

Forward pressure on the control column during the initial portion of the takeoff roll (below approximately 80 knots) increases nose wheel steering effectiveness.

During takeoffs on icy runways, lag in rudder pedal steering and possible nose wheel skidding must be anticipated. Keep the airplane on the centerline with rudder pedal steering and rudder. The rudder becomes effective between 40 - 60 knots. If deviations from the centerline cannot be controlled either during the start of the takeoff roll or until the rudder becomes effective, immediately reject the takeoff.

Takeoff Field Length - Title 14, CFR

The takeoff field length is the longest of the following:

- the distance required to accelerate with all engines, experience an engine failure 1 second prior to V₁, continue the takeoff and reach a point 35 feet above the runway at V₂ speed. (Accelerate-Go Distance).
- the distance required to accelerate with all engines, experience an event 1 second prior to V₁, recognize the event, initiate the stopping maneuver and stop within the confines of the runway (Accelerate-Stop Distance).
- 1.15 times the all engine takeoff distance required to reach a point 35 feet above the runway.

The AFM accelerate-stop distance includes the distance traveled while initiating the stop and is based on the measured stopping capability as demonstrated during certification flight test. This distance includes the use of speedbrakes and maximum braking; it does not include the use of reverse thrust. Operationally, the use of reverse thrust and autobrakes are recommended, however, maximum braking can be achieved either manually or with the autobrake set to RTO.

737 NG Flight Crew Training Manual

Calculating a V_1 speed that equates accelerate-go and accelerate-stop distances defines the minimum field length required for a given weight. This is known as a “balanced field length” and the associated V_1 speed is called the “balanced V_1 ”. The QRH and FMC provide takeoff speeds based on a balanced V_1 . If either an ATM or fixed derate reduced thrust takeoff is used, the QRH and FMC, if FMC takeoff speeds are available, will provide a balanced V_1 applicable to the lower thrust setting.

Takeoff gross weight must not exceed the climb limit weight, field length limit weight, obstacle limit weight, tire speed limit weight, or brake energy limit. If the weight is limited by climb, obstacle, or brake considerations, the limit weight may be increased by using takeoff speeds that are different from the normal balanced takeoff speeds provided by the QRH or FMC.

Different (unbalanced) takeoff speeds can be determined by using:

- improved climb to increase climb or obstacle limited weights
- maximum V_1 policy to increase obstacle limited weights
- minimum V_1 policy to increase brake energy limited weights
- clearway or stopway to increase field or obstacle limited weights.

If the takeoff weight is not based on normal balanced V_1 , the QRH and FMC takeoff speeds are not applicable and the operator should provide the pilot with a method to obtain the appropriate takeoff speeds.

Takeoff - Title 14, CFR

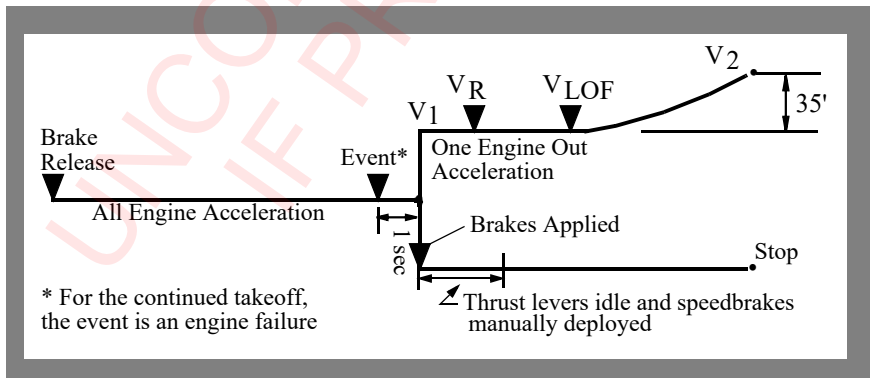

Note: The graphic above refers to dry runway conditions only. Refer to the AFM for detailed wet runway performance information.

Rejected Takeoff Decision

The total energy that must be dissipated during an RTO is proportional to the square of the airplane velocity. At low speeds (up to approximately 80 knots), the energy level is low. Therefore, the airplane should be stopped if an event occurs that would be considered undesirable for continued takeoff roll or flight.

Examples include Master Caution, unusual vibrations or tire failure.

Note: Refer to the Rejected Takeoff NNM in the QRH for guidance concerning the decision to reject a takeoff below and above 80 knots.

As the airspeed approaches V1 during a balanced field length takeoff, the effort required to stop can approach the airplane maximum stopping capability. Therefore, the decision to stop must be made before V1.

Historically, rejecting a takeoff near V1 has often resulted in the airplane stopping beyond the end of the runway. Common causes include initiating the RTO after V1 and failure to use maximum stopping capability (improper procedures/techniques). Effects of improper RTO execution are shown in the diagrams located in the RTO Execution Operational Margins section of this chapter. The maximum braking effort associated with an RTO is a more severe level of braking than most pilots experience in normal service.

Rejecting the takeoff after V1 is not recommended unless the captain judges the airplane incapable of flight. Even if excess runway remains after V1, there is no assurance that the brakes have the capacity to stop the airplane before the end of the runway.

There have been incidents where pilots have missed FMC alerting messages informing them that the takeoff speeds have been deleted or they have forgotten to set the airspeed bugs. If, during a takeoff, the crew discovers that the V speeds are not displayed and there are no other fault indications, the takeoff may be continued. The lack of displayed V speeds with no other fault indications does not fit any of the published criteria for rejecting a takeoff (refer to the Rejected Takeoff NNM in the QRH). In the absence of displayed V speeds, the PM should announce V1 and VR speeds to the PF at the appropriate times during the takeoff roll. The V2 speed should be displayed on the MCP and primary airspeed indicators. If neither pilot recalls the correct rotation speed, rotate the airplane 5 to 10 knots before the displayed V2 speed.

Rejected Takeoff Maneuver

Proper takeoff performance planning, a timely reject decision and completion of the RTO NNM normally allows the airplane to slow to taxi speed before the end of the runway. If the captain determines stopping distance may be critical, maximum braking effort and full reverse thrust may be necessary until the airplane is brought to a complete stop.

737 NG Flight Crew Training Manual

The RTO NNM is initiated during the takeoff roll to expeditiously stop the airplane on the runway. The PM should closely monitor essential instruments during the takeoff roll and immediately announce abnormalities, such as “ENGINE FIRE”, “ENGINE FAILURE”, or any adverse condition significantly affecting safety of flight. The decision to reject the takeoff is the responsibility of the captain, and must be made before V1 speed. If the captain is the PM, he should initiate the RTO and announce the abnormality simultaneously.

Note: If the decision is made to reject the takeoff, the flight crew should accomplish the rejected takeoff non-normal maneuver as described in the Maneuvers Chapter of the QRH.

If the takeoff is rejected before the THR HLD annunciation, the autothrottle should be disconnected as the thrust levers are moved to idle. If the autothrottle is not disconnected, the thrust levers advance to the selected takeoff thrust position when released. After THR HLD is annunciated, the thrust levers, when retarded, remain in idle. For procedural consistency, disconnect the autothrottle for all rejected takeoffs.

During a rejected takeoff the captain determines the need to clear the runway and assesses whether remote parking is needed. During high energy rejected takeoffs wheel fuse plug melting is a consideration as it may prevent further movement of the aircraft. If rejecting due to fire, in windy conditions, consider positioning the airplane so the fire is on the downwind side. Notify the passengers and cabin crew of the actions to be taken. Depending on the cause of the rejected takeoff decision, completion of a non-normal checklist(s) may be needed.

Note: The considerations provided in the RTO NNM are not listed in any particular priority. The flight crew determines the proper sequence of execution for the situation.

After an RTO, comply with brake cooling requirements before attempting a subsequent takeoff.

Go/Stop Decision Near V1

It was determined when the aviation industry produced the Takeoff Safety Training Aid in 1992 that the existing definition of V1 might have caused confusion because they did not make it clear that V1 is the maximum speed at which the flight crew must take the first action to reject a takeoff. The U.S. National Transportation Safety Board (NTSB) also noted in their 1990 study of rejected takeoff accidents, that the late initiation of rejected takeoffs was the leading cause of runway excursions. As a result, the FAA has changed the definition of V1 in 14 CFR Part 25 to read as follows:

- V1 means the maximum speed in the takeoff at which the pilot must take the first action (e.g., apply brakes, reduce thrust, deploy speedbrakes) to stop the airplane within the accelerate-stop distance and
- V1 also means the minimum speed in the takeoff, following a failure of an engine at which the pilot can continue the takeoff and achieve the required height above the takeoff surface within the takeoff distance.

Pilots know that V1 is fundamental to making the Go/Stop decision. Under runway limited conditions, if the reject procedure is initiated at V1, the airplane can be stopped before reaching the end of the runway. See RTO Execution Operational Margins diagrams for the consequences of initiating a reject after V1 and/or using improper procedures.

When the takeoff performance in the AFM is produced, it assumes an engine failure or event one-second before V1. In a runway limited situation, this means the airplane reaches a height of 35 feet over the end of the runway if the decision is to continue the takeoff.

Within reasonable limits, even if the engine failure occurs earlier than the assumed one second before V1, a decision to continue the takeoff will mean that the airplane is lower than 35 feet at the end of the runway, but it is still flying. For example, if the engine fails 2 seconds before V1 and the decision is made to go, the airplane will reach a height of 15 to 20 feet at the end of the runway.

Although training has historically centered on engine failures as the primary reason to reject, statistics show engine thrust loss was involved in approximately one quarter of the accidents, and wheel or tire problems have caused almost as many accidents and incidents as have engine events. Other reasons that rejects occurred were for configuration, indication or light, crew coordination problems, bird strikes or ATC problems.

It is important to note that the majority of past RTO accidents were not the result of an RTO initiated because of an engine failure. Full takeoff thrust from all engines was available. With normal takeoff thrust, the airplane should easily reach a height of 150 feet over the end of the runway, and the pilot has the full length of the runway to stop the airplane if an air turnback is required.

737 NG Flight Crew Training Manual

Making the Go/Stop decision starts long before V1. Early detection, good crew coordination and quick reaction are the keys to a successful takeoff or stop.

RTO Execution Operational Margins

A successful rejected takeoff at or near V1 is dependent upon the captain making timely decisions and using the proper procedures.

The data in the following diagrams, extracted from the Takeoff Safety Training Aid, are provided as a reference. The individual diagrams show the approximate effects of various configuration items and procedural variations on the stopping performance of the airplane. These calculations are frequently based on estimated data and are intended for training discussion purposes only. The data are generally typical of the airplane at heavy weights, and except as noted otherwise, are based on the certified transition time.

Each condition is compared to the baseline condition. The estimated speed at the end of the runway and the estimated overrun distance are indicated at the right edge of each figure. The distance estimates assume an overrun area that can produce the same braking forces as the runway surface. If less than the baseline FAA accelerate-stop distance is required, the distance is denoted as a negative number.

UNCONTINUED
IF PRINTED

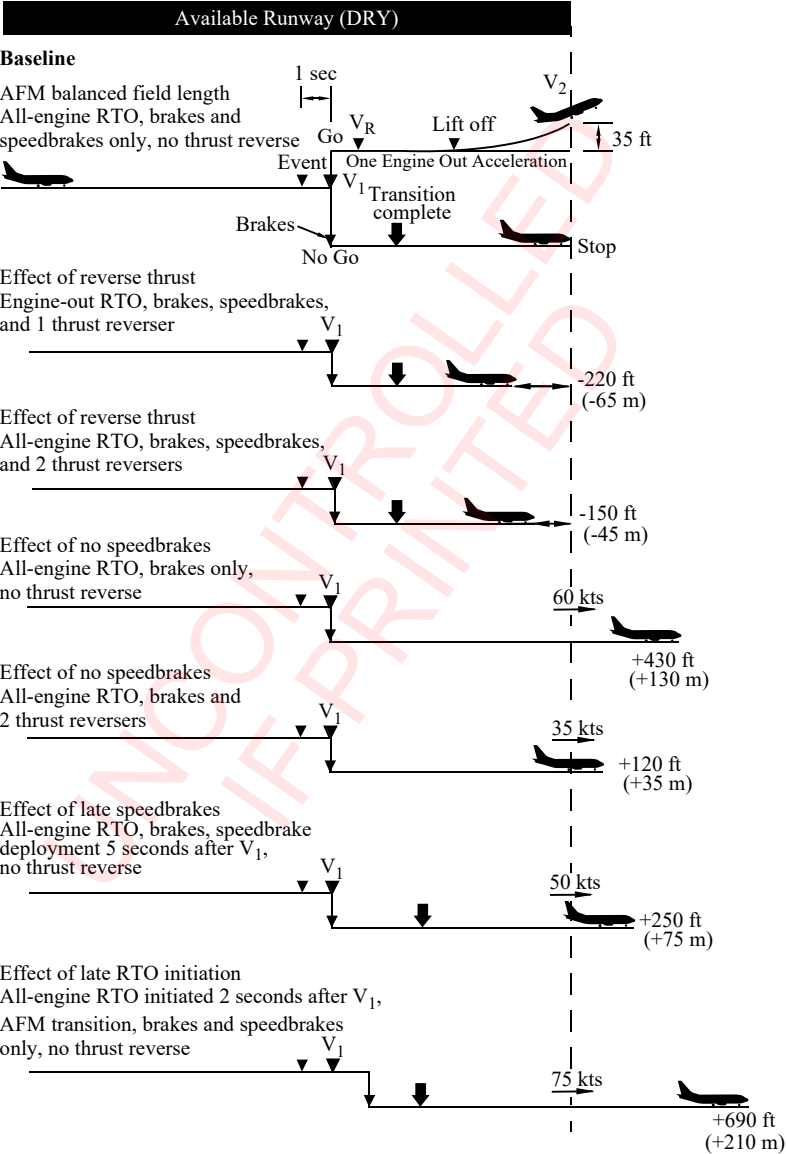

737 NG Flight Crew Training Manual

Available Runway (DRY)

Effect of less than maximum braking effort

All-engine RTO, 3/4 brake pressure, speedbrakes, and 2 thrust reversers

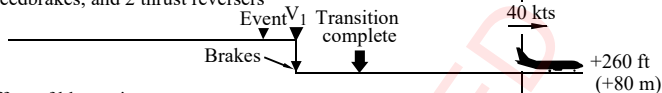
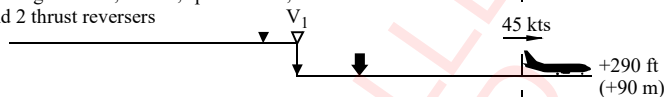

 Effect of blown tire
 All-engine RTO, brakes, speedbrakes, and 2 thrust reversers

Available Runway (WET)

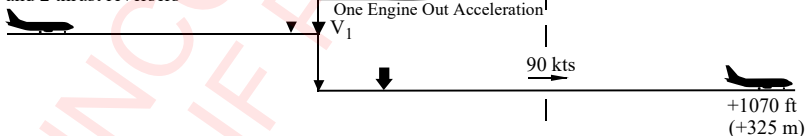
 Effect of using dry runway performance (limit weight and V_1) on wet runway

All-engine RTO, brakes, speedbrakes, and 2 thrust reversers

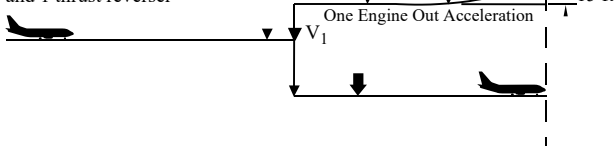
 Effect of using wet runway performance (reduced V_1 and GW)

Engine-out RTO, brakes, speedbrakes, and 1 thrust reverser



Initial Climb - All Engines

After liftoff, use the attitude indicator as the primary pitch reference. The flight director, in conjunction with indicated airspeed and other flight instruments is used to maintain the proper vertical flight path. Pitch, airspeed, and airspeed trends must be crosschecked whether the flight director is used or not.

After liftoff, the flight director commands pitch to maintain an airspeed of $V_2 + 20$ knots until another pitch mode is engaged.

$V_2 + 20$ knots is the optimum climb speed with takeoff flaps. It results in the maximum altitude gain in the shortest distance from takeoff. Acceleration to higher speeds reduces the altitude gain. If airspeed exceeds $V_2 + 20$ knots during the initial climb, stop the acceleration but do not attempt to reduce airspeed to $V_2 + 20$ knots. Any speed between $V_2 + 15$ and $V_2 + 25$ knots results in approximately the same takeoff profile. Crosscheck indicated airspeed for proper initial climb speed.

Retract the landing gear after a positive rate of climb is indicated on the altimeter. Do not apply brakes after becoming airborne. Automatic wheel braking occurs during gear retraction. After gear and flaps are retracted, the PM should verify that the gear and flap indications are normal.

Minimum Fuel Operation - Takeoff

The minimum fuel recommended for takeoff is trip fuel plus reserves. On very short flights this fuel quantity may not be enough to prevent forward fuel pump low pressure lights from illuminating after takeoff.

If any main tank fuel pump indicates low pressure do not turn off fuel pump switches. Avoid rapid acceleration of the airplane, reduce nose-up body attitude and maintain minimum nose-up body angle required for a safe climb gradient.

Immediate Turn after Takeoff - All Engines

Obstacle clearance, noise abatement, or departure procedures may require an immediate turn after takeoff. Initiate the turn at the appropriate altitude (normally at least 400 feet AGL) and maintain $V_2 + 15$ to $V_2 + 25$ knots with takeoff flaps.

Note: A maximum bank angle of 30° is permitted at $V_2 + 15$ knots with takeoff flaps.

After completing the turn, and at or above acceleration height, accelerate and retract flaps while climbing.

Note: The possibility of an engine failure along the departure track must be considered. Special engine out procedures, if available, are preferable to a takeoff weight reduction to ensure all obstacles are cleared.

Roll Modes

If LNAV was not selected (FMC U10.6 and earlier) or armed (FMC U10.7 and later) before takeoff, select LNAV after takeoff when climb is stabilized and after passing 400 feet AGL. If LNAV was selected (FMC U10.6 and earlier) or armed (FMC U10.7 and later) before takeoff, LNAV guidance becomes active at 50 feet AGL if the active leg is within 3.0 NM and 5° of the runway heading. If the departure procedure or route does not begin at the end of the runway, it may be necessary to use the HDG SEL mode at 400 feet AGL to intercept the desired track for LNAV capture. When the departure procedure is not a part of the active flight plan, use HDG SEL or VOR LOC mode. When an immediate turn after takeoff is necessary, the desired heading may be preset before takeoff.

Note: For all airplanes equipped with the HDG SEL takeoff option, leave runway heading selected until turn initiation.

Nav aids and appropriate radials or tracks required for use during the departure may be displayed on the navigation display using the FIX page feature and/or VOR/ADF switches on the EFIS control panel. Use of the STA and WPT switches on the EFIS control panel provides additional information on the navigation display.

Pitch Modes

On airplanes with FMC U10.7 and earlier, at thrust reduction altitude, select or verify that climb thrust is set. At acceleration height, set flaps up maneuver speed and retract flaps on the Flap Retraction Schedule.

On airplanes with FMC U10.8 and later, VNAV, armed on the ground with the appropriate acceleration altitude entered, is the recommended pitch mode for takeoff. When armed for takeoff, VNAV engages at 400 feet AGL and provides AFDS management for acceleration, flap retraction and climb out. The VNAV profile and acceleration schedule is compatible with most planned departures.

With VNAV engaged, acceleration is automatically commanded. Retract flaps on schedule. Check that the thrust reference changes from TO to CLB (or any reduced climb mode) at the point selected on the takeoff reference page.

If VNAV is not used, at acceleration height set the command speed to flaps up maneuver speed. At thrust reduction altitude, verify that climb thrust is set at the point selected on the takeoff reference page. If the thrust reference does not change automatically, select climb thrust.

On airplanes with FMC U10.6 and earlier, after flaps and slats retraction is complete, select VNAV or set the desired climb speed in the MCP speed window. Before selecting VNAV, flaps should be retracted because VNAV does not provide overspeed protection for the leading edge devices. If the autopilot is engaged prior to engaging VNAV, the AFDS reverts to LVL CHG, and the FMA pitch mode changes from TO/GA to MCP SPD. If a pitch mode other than TO/GA is engaged when the autopilot is engaged, the AFDS will remain in that mode.

On airplanes with FMC U10.7 and later, VNAV can be engaged anytime because VNAV provides overspeed protection for the leading edge devices. If VNAV is armed for takeoff, the AFDS remains in VNAV when the autopilot is engaged. If a pitch mode other than VNAV is engaged when the autopilot is engaged, the AFDS will remain in that mode.

Autopilot Engagement

The autopilot is FAA certified to allow engagement at or above 400 feet AGL after takeoff. Other NAA regulations or airline operating directives may specify a different minimum altitude. The airplane should be in trim, and the flight director commands should be satisfied before autopilot engagement. This prevents unwanted changes from the desired flight path during autopilot engagement.

Flap Retraction Schedule

The minimum altitude for flap retraction is 400 feet.

The altitude selected for acceleration and flap retraction may be specified for each airport. Safety, obstruction clearance, airplane performance or noise abatement requirements are usually the determining factors. Some operators have adopted a standard climb profile for all of their operations based on the airport which requires the greatest height for level off to clear a close-in obstacle with an engine failure.

During training flights, 1,000 feet AFE is normally used as the acceleration height to initiate thrust reduction and flap retraction. For noise abatement considerations during line operations, thrust reduction typically occurs at approximately 1,500 feet AFE and acceleration typically occurs between 1,500 and 3,000 feet AFE, or as specified by individual airport noise abatement procedures.

Note: For airplanes equipped with EFB, the ACCEL HT value displayed on the PERFORMANCE - TAKEOFF page may be used as the acceleration height to initiate thrust reduction and flap retraction.

737 NG Flight Crew Training Manual

During flap retraction, selection of the next flap position is initiated when reaching the maneuver speed for the existing flap position. Therefore, when the new flap position is selected, the airspeed is below the maneuver speed for that flap position. For this reason, the airspeed should be increasing when selecting the next flap position. During flap retraction, at least adequate maneuver capability or 30° of bank (15° of bank and 15° overshoot) to stick shaker is provided at the flap retraction speed. Full maneuver capability or at least 40° of bank (25° of bank and 15° overshoot) is provided when the airplane has accelerated to the recommended maneuver speed for the selected flap position.

Begin flap retraction at $V_2 + 15$ knots, except for a flaps 1 takeoff. For a flaps 1 takeoff, begin flap retraction when reaching the flaps 1 maneuver speed.

With airspeed increasing, subsequent flap retractions should be initiated when airspeed reaches the maneuver speed for the existing flap position. The maneuver speed for the existing flap position is indicated by the numbered flap maneuver speed bugs on the airspeed display.

Takeoff Flap Retraction Speed Schedule

T/O Flaps	At Speed (display)	Select Flaps
25	$V_2 + 15$	15
	“15”	5
	“5”	1
	“1”	UP
15 or 10	$V_2 + 15$	5
	“5”	1
	“1”	UP
5	$V_2 + 15$	1
	“1”	UP
1	“1”	UP
Limit bank angle to 15° until reaching $V_2 + 15$ knots		

For flaps up maneuvering, maintain at least:

- “UP”

Noise Abatement Takeoff

Thrust reduction height and acceleration height (airplanes with FMC U10.7 and later) can be entered on the takeoff reference page. Following flap retraction, maintain flaps up maneuver speed until the noise abatement profile is satisfied and the airplane is clear of obstacles or above any minimum crossing altitude. This is normally achieved through the FMC speed restriction entered on the CLB page. It may be also be accomplished using speed intervention (as installed) or LVL CHG.

Note: Specific local airport procedures should be followed.

UNCONTROLLED
IF PRINTED

Takeoff - Engine Failure

General

Differences between normal and engine out profiles are few. One engine out controllability is excellent during takeoff roll and after liftoff. Minimum control speed in the air is below VR and VREF.

Engine Failure Recognition

An engine failure at or after V1 initially affects yaw much like a crosswind effect. Vibration and noise from the affected engine may be apparent and the onset of the yaw may be rapid.

The airplane heading is the best indicator of the correct rudder pedal input. To counter the thrust asymmetry due to an engine failure, stop the yaw with rudder. Flying with lateral control wheel displacement or with excessive aileron trim causes spoilers to be raised.

Rotation and Liftoff - One Engine Inoperative

If an engine fails between V1 and liftoff, maintain directional control by smoothly applying rudder proportionate with thrust decay.

During a normal all engine takeoff, a smooth continuous rotation toward 15° of pitch is initiated at VR. With an engine inoperative, a smooth continuous rotation is also initiated at VR; however, the target pitch attitude is approximately 2° to 3° below the normal all engine pitch attitude resulting in a 12° to 13° target pitch attitude. The rate of rotation with an engine inoperative is also slightly slower (1/2° per second less) than that for a normal takeoff, resulting in a rotation rate of approx 1.5° to 2.5° per second. After liftoff adjust pitch attitude to maintain the desired speed.

If the engine failure occurs at or after liftoff apply rudder and aileron to control heading and keep the wings level. In flight, correct rudder input approximately centers the control wheel. To center the control wheel, rudder is required in the direction that the control wheel is displaced. This approximates a minimum drag configuration.

Typical Rotation - One Engine Inoperative

Liftoff attitude depicted in the following tables should be achieved in approximately 5 seconds. Adjust pitch attitude, as needed, to maintain desired airspeed of V_2 to $V_2 + 20$ knots.

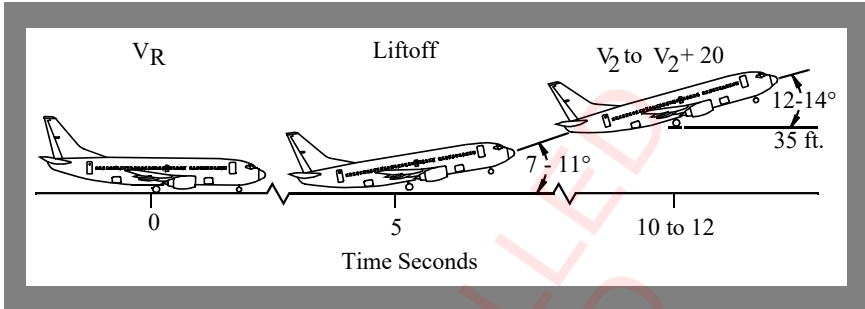

Retract the landing gear after a positive rate of climb is indicated on the altimeter. Retract flaps in accordance with the technique described in this chapter.

737 NG Flight Crew Training Manual

Typical Takeoff Tail Clearance - One Engine Inoperative

The following diagram and table show the effect of flap position on liftoff pitch attitude and minimum tail clearance during takeoff with one engine inoperative. Additionally, the last column shows the pitch attitude for tail contact with wheels on the runway and landing gear struts extended. The tail strike pitch attitude remains the same as during takeoffs with all engines operating. For a discussion of tail strike procedures, see Chapter 8 and the FCOM.

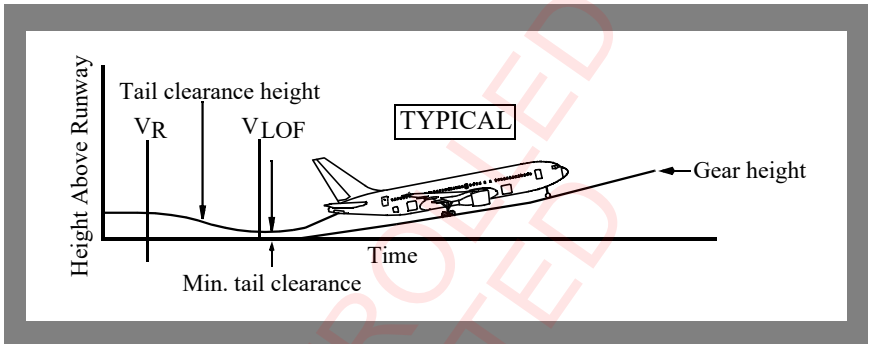

Model	Flaps	Liftoff Attitude (degrees)	Minimum Tail Clearance inches (cm)	Tail Strike Pitch Attitude (degrees)
737-600	1	11.0	24 (61)	16.2
	5	11.0	24 (61)	
	10	10.8	25 (64)	
	15	10.5	26 (66)	
	25	10.2	28 (71)	
737-700	1	11.0	18 (46)	14.7
	5	11.0	18 (46)	
	10	10.8	19 (48)	
	15	10.6	21 (53)	
	25	10.2	23 (58)	



737 NG Flight Crew Training Manual

Model	Flaps	Liftoff Attitude (degrees)	Minimum Tail Clearance inches (cm)	Tail Strike Pitch Attitude (degrees)
737-800	1	9.0	8 (20)	11.0
	5	8.7	11 (28)	
	10	8.4	14 (36)	
	15	8.2	15 (38)	
	25	8.0	17 (43)	
737-900	1	8.5	9 (23)	10.0
	5	8.3	11 (28)	
	10	8.1	14 (36)	
	15	7.7	16 (41)	
	25	7.6	18 (46)	
737-900ER	1	8.5	9 (23)	10.0
	5	8.3	11 (28)	
	10	7.7	16 (41)	
	15	7.6	18 (46)	
	25	7.4	21 (53)	

Initial Climb - One Engine Inoperative

The initial climb attitude should be adjusted to maintain a minimum of V_2 and a positive climb. After liftoff the flight director provides proper pitch guidance for the engine inoperative condition. Crosscheck indicated airspeed, vertical speed and other flight instruments. The flight director commands a minimum of V_2 , or the existing speed up to a maximum of $V_2 + 20$ knots.

If the flight director is not used, attitude and indicated airspeed become the primary pitch references.

Retract the landing gear after a positive rate of climb is indicated on the altimeter. The initial climb attitude should be adjusted to maintain a minimum of V_2 . If an engine fails at an airspeed between V_2 and $V_2 + 20$ knots, climb at the airspeed at which the failure occurred. If engine failure occurs above $V_2 + 20$ knots, increase pitch to reduce airspeed to $V_2 + 20$ knots and maintain $V_2 + 20$ knots until reaching acceleration height. After flap retraction and all obstructions are cleared, on the FMC ACT ECON CLB page, select ENG OUT followed by the prompt corresponding to the failed engine. This displays the MOD ENG OUT CLB page (ENG OUT CLB for FMC U10.3 and later) which provides advisory data for an engine out condition.

The flight director roll mode commands wings level or HDG SEL (as installed) after liftoff until LNAV engagement or another roll mode is selected. If ground track is not consistent with desired flight path, use HDG SEL/LNAV to achieve the desired track.

Indications of an engine fire, impending engine breakup or approaching or exceeding engine limits, should be dealt with as soon as possible. Accomplish the appropriate memory checklist items as soon as the flight path is under control, the gear has been retracted, and a safe altitude has been attained (minimum 400 feet AGL). Reference items should be accomplished by the PM as soon as practical.

If an engine failure has occurred during initial climb, accomplish the appropriate checklist after the flaps have been retracted and conditions permit.

Immediate Turn after Takeoff - One Engine Inoperative

Obstacle clearance or departure procedures may require a special engine out departure procedure. If an immediate turn is required, initiate the turn at the appropriate altitude (normally at least 400 feet AGL). Maintain V_2 to $V_2 + 20$ knots with takeoff flaps while maneuvering.

Note: Limit bank angle to 15° until $V_2 + 15$ knots. Bank angles up to 30° are permitted at $V_2 + 15$ knots with takeoff flaps. With LNAV engaged, the AFDS may command bank angles greater than 15° .

After completing the turn, and at or above acceleration height, accelerate and retract flaps.

Autopilot Engagement - One Engine Inoperative

When at a safe altitude above 400 feet AGL with correct rudder pedal or trim input, the autopilot may be engaged. For airplanes with FMC U10.8 or later, when VNAV is armed for takeoff, the autopilot is normally engaged anytime the airplane is above the minimum altitude for autopilot engagement. For airplanes with FMC U10.7 or earlier, autopilot engagement is normally delayed until the flaps are up and LVL CHG is selected. This allows the AFDS to remain in the TO/GA mode during flap retraction.

Flap Retraction - One Engine Inoperative

The minimum altitude for flap retraction with an engine inoperative is 400 feet AGL. During training, Boeing uses 1,000 feet AFE as a standard altitude to initiate acceleration for flap retraction.

Acceleration height for a takeoff with an engine failure after V1 is based on accelerating to the recommended flaps up speed while retracting flaps and selecting the maximum continuous thrust limit within 5 minutes (10 minutes optional) after initiating takeoff. Some combinations of high gross weight, takeoff flap selection and airport elevation may require initiating flap retraction as low as 400 feet after takeoff with an engine failure.

At typical training weights, adequate performance exists to climb to 1,000 feet before beginning flap retraction. Therefore, during training 1,000 feet is used as the acceleration height for engine failure after V1.

On airplanes with FMC U10.7 and earlier, at engine out acceleration height, select flaps up maneuver speed on the MCP. Engine-out acceleration and climb capability for flap retraction are functions of airplane thrust to weight ratio. The flight director commands a near level or a slight climb (0-200 fpm) flap retraction segment. Accelerate and retract flaps on the takeoff flap retraction speed schedule.

On airplanes with FMC U10.8 and later, at engine out acceleration height, if VNAV is engaged, a near-level climb segment is commanded for acceleration. Retract flaps on the takeoff flap retraction speed schedule.

On airplanes with FMC U10.8 and later, If VNAV is not engaged, leave the pitch mode in TO/GA and select flaps up maneuver speed on the MCP. Engine-out acceleration and climb capability for flap retraction are functions of airplane thrust to weight ratio. The flight director commands a near level or a slight climb (0-200 fpm) flap retraction segment. Accelerate and retract flaps on the takeoff flap retraction speed schedule.

If the flight director is not being used at acceleration height, decrease pitch attitude to maintain approximately level flight while accelerating. Retract flaps on the takeoff flap retraction speed schedule.

737 NG Flight Crew Training Manual

As the airplane accelerates and flaps are retracted, adjust the rudder pedal position to maintain the control wheel centered and trim to relieve rudder pedal pressure.

Flaps Up - One Engine Inoperative

On airplanes with FMC U10.7 and earlier, after flap retraction and at or above flaps up maneuver speed, select LVL CHG, set maximum continuous thrust (CON) and continue the climb to the obstacle clearance altitude.

On airplanes with FMC U10.8 and later, after flap retraction and at or above flaps up maneuver speed, with VNAV engaged and flaps up the FMC commands a climb at flaps up maneuver speed. Set maximum continuous thrust (CON) and continue the climb to the obstacle clearance altitude. If VNAV is not engaged, select LVL CHG.

Initiate the appropriate engine failure non-normal checklist followed by the After Takeoff checklist when the flaps are up and thrust is set. Remain at flaps up maneuver speed until all obstructions are cleared, then select the engine-out schedule from the CDU CLB page (depending on the next course of action). Ensure the autothrottle is disconnected before reaching level off altitude. After level off, set thrust as needed.

Noise Abatement - One Engine Inoperative

When an engine failure occurs after takeoff, noise abatement is no longer a requirement.

Engine Failure During a Reduced Thrust (ATM) Takeoff

Since the reduced thrust (ATM) takeoff must still comply with all regulatory takeoff performance requirements, it is not necessary to increase thrust beyond the reduced level on the operating engine in the event of an engine failure. However, if more thrust is needed during an ATM takeoff, thrust on the operating engine may be increased to full rated takeoff thrust by manually advancing the thrust lever. This is because the takeoff speeds consider VMCG and VMCA at the full rated takeoff thrust.

Increasing thrust on the operating engine to full rated takeoff thrust provides additional performance margin. This additional performance margin is not a requirement for the reduced thrust takeoff and its use is at the discretion of the flight crew.

Engine Failure During a Derated Thrust (Fixed Derate) Takeoff

During a fixed derate takeoff, a thrust increase following an engine failure could result in loss of directional control and should not be accomplished unless, in the opinion of the captain, terrain clearance cannot be assured. This is because the takeoff speeds consider VMCG and VMCA only at the fixed derate level of thrust.

Engine Failure During a Combined ATM and Fixed Derate Takeoff

Appendix A.2.6

Although the ATM takeoff thrust setting is not considered a takeoff operating limit, the selected fixed derate is still considered a takeoff operating limit. This is because takeoff speeds consider VMCG and VMCA only at the fixed derate level of thrust. If an engine failure occurs during takeoff, any thrust increase beyond the fixed derate limit could result in loss of directional control and should not be accomplished unless in the opinion of the captain, terrain clearance cannot be assured.

If an engine failure occurs during takeoff when using both the reduced thrust (ATM) and fixed derate methods:

- on airplanes with the double derate option, Boeing recommends that the thrust levers not be advanced since the fixed derate limit is not displayed on engine or flight instruments. However, if operators have developed a procedure that makes the fixed derate immediately available to the crew, thrust may be advanced to the fixed derate limit only.
- on airplanes without the double derate option, the reference N1 bug shows the fixed derate limit. Thrust may be advanced to the fixed derate limit only.

UNCONFIDENTIAL
IF PRINTED



Climb, Cruise, Descent and Holding

Chapter 4

Table of Contents

Section TOC

Preface **4.1**

Climb **4.1**

 Reduced Thrust Climb. 4.1

 Climb Constraints 4.1

 Low Altitude Level Off. 4.2

 Transition to Climb 4.3

 Climb Speed Determination 4.3

 Engine Icing During Climb 4.3

 Economy Climb. 4.4

 Economy Climb Schedule - FMC Data Unavailable 4.4

 Maximum Rate Climb. 4.4

 Maximum Angle Climb. 4.4

 Engine Inoperative Climb 4.4

Cruise **4.5**

 Maximum Altitude 4.5

 Optimum Altitude 4.6

 Cruise Speed Determination 4.7

 Step Climb. 4.7

 Low Fuel Temperature 4.8

 Cruise Performance Economy. 4.9

 Engine Inoperative Cruise/Driftdown 4.11

 High Altitude High Speed Flight. 4.13

 ETOPS. 4.13

 Polar Operations 4.15

Descent **4.17**

 Descent Speed Determination 4.17

 Descent Path 4.17

Descent Constraints	4.17
Speed Intervention (As installed)	4.18
Descent Preparation Using HUD System	4.18
Descent Planning	4.18
Descent Rates	4.18
Speedbrakes	4.19
Flaps and Landing Gear	4.20
Speed Restrictions	4.21
Engine Icing During Descent	4.21
Holding	4.21
Holding Airspeeds	4.22
Procedure Holding	4.22
Holding Airspeeds Not Available from the FMC	4.23

UNCONTROLLED
IF PRINTED



Preface

This chapter outlines recommended operating practices and techniques used during climb, cruise, descent and holding. Loss of an engine during climb or cruise and engine inoperative cruise/driftdown is also addressed. The recommended operating practices and techniques discussed in this chapter improve crew coordination, enhance safety, and provide a basis for standardization.

Climb

Reduced Thrust Climb

Engine service life may be extended by operating the engines at less than full climb rated thrust.

The FMC provides two reduced thrust climb selections on the N1 LIMIT page:

- CLB 1 is approximately a 10% derate of climb thrust
- CLB 2 is approximately a 20% derate of climb thrust.

Reduced thrust climb may also be automatically selected by the FMC depending upon the amount of thrust reduction made for takeoff by either the fixed derate or assumed temperature method.

Climb thrust reductions are gradually removed as the airplane climbs until full climb thrust is restored. If rate of climb should drop below approximately 500 feet per minute, the next higher climb rating should be selected.

Prior to takeoff, the pilot may override the automatically selected climb thrust limit after the takeoff selection has been completed by selecting another climb thrust limit on the N1 LIMIT page. When the automatically selected climb thrust limit is overridden, the previously selected takeoff derate is not affected.

Note: Use of reduced thrust for climb increases total trip fuel and should be evaluated by each operator.

Climb Constraints

Climb constraints may be automatically entered in the route when selecting a procedure, or manually entered through CDU entry. When the airplane levels off at an MCP altitude, that altitude is treated as a climb constraint by the FMC.

Normally, set all maximum or hard altitude constraints in the MCP altitude window. The next altitude may be set when the restriction has been assured or further clearance has been received. This procedure provides altitude alerting and ensures compliance with altitude clearance limits.

When using VNAV, if altitude constraints are closely spaced to the extent that crew workload is adversely affected and unwanted level-offs are a concern, the alternate MCP altitude setting technique can be used with operator approval. Refer to Chapter 1, MCP Altitude Setting Techniques Using VNAV for more information on this subject.

Note: When the alternate MCP altitude setting technique using VNAV is used, the selection of a pitch mode other than VNAV SPD for climbs results in a risk of violating altitude constraints.

For climbs in pitch modes other than VNAV SPD, set the MCP altitude to the next altitude constraint or the clearance altitude, whichever is lower. For altitude constraints that are "at or above" set the clearance altitude.

When relieved of constraints by ATC, use of LVL CHG or VNAV with MCP altitude intervention (as installed) is recommended in congested areas, or during times of high workload. Altitude intervention (as installed) is accomplished by selecting the next desired altitude in the MCP altitude window, pushing the MCP ALT INTV switch which deletes the altitude constraint and allows the airplane to climb to the MCP altitude.

Low Altitude Level Off

Occasionally a low altitude climb restriction is required after takeoff. This altitude restriction should be set in the MCP altitude window. When the airplane approaches this altitude, the mode annunciation changes to VNAV ALT (as installed) and the airplane levels off. For airplanes without VNAV ALT installed, the mode annunciation initially changes to ALT ACQ, then ALT HOLD.

Note: If ALT ACQ occurs before N1 is selected, automatic thrust reduction occurs and the autothrottle speed mode engages.

High Takeoff Thrust - Low Gross Weight

When accomplishing a low altitude level off following a takeoff using high takeoff thrust and at a low gross weight, the crew should consider the following factors:

- altitude capture can occur just after liftoff due to the proximity of the level off altitude and the high climb rate of the airplane
- the AFDS control laws limit F/D and autopilot pitch commands for passenger comfort
- there may not be enough altitude below the intended level off altitude to complete the normal capture profile and an overshoot may occur unless crew action is taken.

To prevent an altitude and/or airspeed overshoot, the crew should consider doing one or more of the following:

- use reduced thrust for takeoff at low weights whenever possible
- reduce from takeoff to climb thrust earlier than normal

- disengage the AFDS and complete the level off manually if there is a possibility of an overshoot
- use manual thrust control as needed to manage speed and prevent flap overspeeds.

Transition to Climb

Maintain flaps up maneuver speed until clear of obstacles or above minimum crossing altitudes. If there are no altitude or airspeed restrictions, accelerate to the desired climb speed schedule. The sooner the airplane can be accelerated to the climb speed schedule, the more time and fuel efficient the flight.

Climb Speed Determination

Enroute climb speed is automatically computed by the FMC and displayed on the CLB page. It is also displayed as command speed when VNAV is engaged. Below the speed transition altitude the FMC targets the transition speed limit stored in the navigation database for the departure airport (250 knots below 10,000 feet MSL in FAA airspace). The FMC applies waypoint-related speed restrictions displayed on the LEGS pages, and altitude-related speed restrictions displayed on the CLB page.

The FMC provides optimum climb speed modes for economy (ECON) operation and engine out (ENG OUT) operation. These optimum speeds can be changed before or during the climb. Selectable climb speed modes are also provided for maximum angle climb (MAX ANGLE) and maximum rate (MAX RATE) operation.

The ECON climb speed is a constant speed/constant Mach schedule optimized to obtain the minimum airplane operating cost. The constant Mach value is set equal to the economy cruise Mach calculated for the cruise altitude entered in the FMC.

For very low cruise altitudes the economy climb speed is increased above normal values to match the economy cruise speed at the entered cruise altitude. For ECON climb, the speed is a function of predicted gross weight at top of climb, predicted wind at top of climb, predicted temperature deviation from ISA at top of climb, and cost index entered into FMC.

Engine Icing During Climb

Engine icing may form when not expected and may occur when there is no evidence of icing on the windshield or other parts of the airplane. Once ice starts to form, accumulation can build very rapidly. Although one bank of clouds may not cause icing, another bank, which is similar, may cause icing.

Note: The engine anti-icing system should be turned on whenever icing conditions exist or are anticipated. Failure to follow the recommended anti-ice procedures can result in engine stall, overtemperature or engine damage.

Economy Climb

The normal economy climb speed schedule of the FMC minimizes trip cost. The FMC generates a fixed speed schedule as a function of cost index and weight.

Economy climb speed normally exceeds 250 knots for all gross weights. FMC climb speed is limited to 250 knots below 10,000 feet (FAA airspace), or a lower waypoint speed restriction, if entered. If the use of a higher speed below 10,000 feet is allowed, ECON speed provides additional cost savings.

Economy Climb Schedule - FMC Data Unavailable

- 250 knots/VREF 40 + 70 knots, whichever is higher - Below 10,000 feet
- 280 knots/0.78M - Above 10,000 feet

Maximum Rate Climb

A maximum rate climb provides both high climb rates and minimum time to cruise altitude. Maximum rate climb can be approximated by using the following:

- flaps up maneuver speed + 50 knots until intercepting 0.76M

Note: The FMC provides maximum rate climb speeds.

Maximum Angle Climb

The FMC provides maximum angle climb speeds. Maximum angle climb speed is normally used for obstacle clearance, minimum crossing altitude or to reach a specified altitude in a minimum distance. It varies with gross weight and provides approximately the same climb gradient as flaps up maneuver speed.

Engine Inoperative Climb

The recommended engine inoperative climb speed approximates the speed for maximum climb gradient and varies with gross weight and altitude.

If a thrust loss occurs at other than takeoff thrust, set maximum continuous thrust on the operative engine and adjust the pitch to maintain airspeed.

Note: Selecting CON on the FMC N1 LIMIT page moves the N1 bug to maximum continuous thrust until another mode is selected or automatically engaged. Thrust must be manually set.

The MOD ENG OUT CLB (ENG OUT CLB for FMC 10.3 and later) page displays the N1 for maximum continuous thrust, maximum altitude and the engine out climb speed to cruise altitude, or maximum engine out altitude, whichever is lower. Leave thrust set at maximum continuous thrust until airspeed increases to the commanded value.

Note: If computed climb speeds are not available, use flaps up maneuver speed and maximum continuous thrust.

Cruise

This section provides general guidance for the cruise portion of the flight for maximum passenger comfort and economy.

Maximum Altitude

Appendix A.2.6

Maximum altitude is the highest altitude at which the airplane can be operated. It is determined by three basic characteristics, (certified altitude, thrust limit altitude and buffet or maneuver margin) which are unique to each airplane model. The FMC predicted maximum altitude is the lowest of:

- maximum certified altitude - the altitude determined during certification considering structural limit (limits on the fuselage), rapid descent capability, or other factors determined by the certifying authority
- thrust limited altitude - the altitude at which sufficient thrust is available to provide a specific minimum rate of climb. (Reference the Long Range Cruise Maximum Operating Altitude table in the PI Chapter, Volume 1 of the FCOM). Depending on the thrust rating of the engines, the thrust limited altitude may be above or below the maneuver altitude capability
- buffet or maneuver limited altitude - the altitude at which a specific maneuver margin exists prior to buffet onset. This altitude provides a g margin prior to buffet chosen by airline policy. The minimum margin available is 0.3g (40° bank) prior to buffet. Some regulatory agencies may require a different minimum maneuver margin.

Although each of these limits are checked by the FMC, available thrust may limit the ability to accomplish anything other than relatively minor maneuvering. The amber band limits do not provide an indication of maneuver capability as limited by available thrust.

The minimum maneuver speed indication on the airspeed display does not guarantee the ability to maintain level flight at that speed. Decelerating the airplane to the amber band may create a situation where it is impossible to maintain speed and/or altitude because as speed decreases airplane drag may exceed available thrust, especially while turning. Flight crews intending to operate at or near the maximum operation altitude should be familiar with the performance characteristics of the airplane in these conditions.

Note: To get the most accurate altitude limits from the FMC, ensure that the airplane weight, cruise CG, and temperature entries are correct.

For LNAV operation, the FMC provides a real-time bank angle limiting function. This function protects the commanded bank angle from exceeding the current available thrust limit. This bank angle limiting protection is only available when in LNAV.

For operations other than LNAV, when operating at or near maximum altitude fly at least 10 knots above the lower amber band and use bank angles of 10° or less. If speed drops below the lower amber band, immediately increase speed by doing one or more of the following:

- reduce angle of bank
- increase thrust up to maximum continuous
- descend.

Turbulence at or near maximum altitude can momentarily increase the airplane's angle-of-attack and activate the stick shaker. When flying at speeds near the lower amber band, any maneuvering increases the load factor and further reduces the margin to buffet onset and stick shaker.

FMC fuel predictions are not available above the FMC maximum altitude and are not displayed on the CDU. VNAV is not available above FMC maximum altitude. Fuel burn at or above maximum altitude increases. Flight above this altitude is not recommended.

Optimum Altitude

The optimum (OPT) altitude shown on the CRZ page is determined based on aircraft gross weight and cruise speed in still air. When operating in the ECON mode, OPT altitude results in minimum trip cost based on the entered cost index. However, when operation is based on manually entered speed or selected LRC speed, OPT altitude is based on minimum fuel burn. OPT altitude increases as weight decreases during the flight.

OPT altitude calculation does not consider the effects of temperature deviations from standard day or sensed or forecast winds at altitude. Since OPT altitude only provides optimum performance in still air, when factoring winds, it may not be the best altitude for the aircraft to minimize cost or fuel.

For shorter trips, OPT altitude computation is based on ECON speed and uses different logic and different input parameters than long trips.

[Appendix A.2.7](#)

Trip altitude, as defined on the FMC PERF INIT page, further constrains optimum altitude by reducing the altitude for short trips until minimum cruise segment time is satisfied. This cruise time is typically one minute, but is operator selectable in the FMC by maintenance action. For short trips, operation at the trip altitude results in the minimum fuel/cost while also satisfying the minimum cruise time requirement.

Cruise Speed Determination

Cruise speed is automatically computed by the FMC and displayed on the CRZ page. It is also displayed by the command airspeed when VNAV is engaged. The default cruise speed mode is economy (ECON) cruise. The pilot can also select long range cruise (LRC), engine out modes, or overwrite fixed Mach or CAS values on the CRZ page target speed line.

ECON cruise is a variable speed schedule that is a function of gross weight, cruise altitude, cost index, and headwind or tailwind component. It is calculated to provide minimum operating cost for the entered cost index. Entry of zero for cost index results in maximum range cruise.

Headwinds increase the ECON CRZ speed. Tailwinds decrease ECON CRZ speed, but not below the zero wind maximum range cruise airspeed.

LRC is a variable speed schedule providing fuel mileage 1% less than the maximum available. The FMC does not apply wind corrections to LRC.

Required Time of Arrival (RTA) speed is generated to meet a time required at an RTA specified waypoint on the FMC LEGS page.

Step Climb

Flight plans not constrained by short trip distance are typically based on conducting the cruise portion of the flight close to optimum altitude. Since the optimum altitude increases as fuel is consumed during the flight, it is necessary to climb to a higher cruise altitude periodically to achieve the flight plan fuel burn. This technique, referred to as Step Climb Cruise, is typically accomplished by entering an appropriate step climb value in the FMC according to the available cruise levels. For most flights, one or more step climbs may be required before reaching T/D.

It may be especially advantageous to request an initial cruise altitude above optimum if altitude changes are difficult to obtain on specific routes. This minimizes the possibility of being held at a low altitude/high fuel consumption condition for long periods of time. The requested/accepted initial cruise altitude should be compared to the thrust limited or the maneuver margin limited altitudes. Remember, a cruise thrust limited altitude is dependent upon the cruise level temperature. If the cruise level temperature increases above the chart value for gross weight, maximum cruise thrust will not maintain desired cruise speed.

Optimum step points are a function of the route length, flight conditions, speed mode, present airplane altitude, STEP to altitude and gross weight. The FMC does not compute an optimum step point. The crew must enter a STEP to altitude. The FMC then computes the ETA and distance to step climb point based upon gross weight. A fuel savings or penalty to destination is computed assuming the step climb is performed. Initiate a cruise climb to the new altitude as close as practicable to the step climb point.

Boeing Proprietary. Copyright © Boeing. May be subject to export restrictions under EAR. See title page for details.

Fuel for Enroute Climb

The additional fuel required for a 4,000 foot enroute climb varies from 300 to 500 lbs (135 to 225 kgs) depending on the airplane gross weight, initial altitude, air temperature, and climb speed. The fuel increment is largest for high gross weights and low initial altitudes. Additional fuel burn is offset by fuel savings in the descent. It is usually beneficial to climb to a higher altitude if recommended by the FMC or the flight plan, provided the wind information used is reliable.

Note: The fuel saved at higher altitude does not normally justify a step climb unless the cruise time of the higher altitude is approximately 20 minutes or longer.

Low Fuel Temperature

Fuel temperature changes relative to total air temperature. For example, extended operation at high cruise altitudes tends to reduce fuel temperature. In some cases the fuel temperature may approach the minimum fuel temperature limit.

Fuel freezing point should not be confused with fuel ice formation caused by frozen water particles. The fuel freezing point is the temperature at which the formation of wax crystals appears in the fuel. The Jet A fuel specification limits the freezing point to -40°C maximum, while the Jet A-1 limit is -47°C maximum. In the Commonwealth of Independent States (CIS), the fuel is TS-1 or RT, which has a maximum freezing point of -50°C, which can be lower in some geographical regions. The actual uplifted freezing point for jet fuels varies by the geographical region in which the fuel is refined.

Unless the operator measures the actual freezing point of the loaded fuel at the dispatch station, the maximum specification freezing point must be used. At most airports, the measured fuel freezing point can yield a lower freezing point than the specification maximum freezing point. The actual delivered freezing temperature can be used if it is known. Pilots should keep in mind that some airports store fuel above ground and, in extremely low temperature conditions, the fuel may already be close to the minimum allowable temperature before being loaded.

For blends of fuels, use the most conservative freezing point of the fuel on board as the freezing point of the fuel mixture. This procedure should be used until 3 consecutive refuelings with a lower freezing point fuel have been completed. Then the lower freezing point may be used. If fuel freezing point is projected to be critical for the next flight segment, wing tank fuel should be transferred to the center wing tank before refueling. The freezing point of the fuel being loaded can then be used for that flight segment.

Fuel temperature should be maintained within AFM limitations as specified in the Limitations chapter of the FCOM.

Maintaining a minimum fuel temperature should not be a concern unless the fuel temperature approaches the minimum temperature limit. The rate of cooling of the fuel is approximately 3° C per hour, with a maximum of 12° C per hour possible under the most extreme conditions.

Total air temperature can be raised in the following three ways, used individually or in combination:

- climb or descend to a warmer air mass
- deviate to a warmer air mass
- increase Mach number.

Note: In most situations, warmer air can be reached by descending but there have been reports of warmer air at higher flight levels. Air temperature forecasts should be carefully evaluated when colder than normal temperatures are anticipated.

It takes from 15 minutes to one hour to stabilize the fuel temperature. In most cases, the required descent would be 3,000 to 5,000 feet below optimum altitude. In more severe cases, descent to altitudes of 25,000 feet to 30,000 feet might be required. An increase of 0.01 Mach results in an increase of 0.5° to 0.7° C total air temperature.

Cruise Performance Economy

The flight plan fuel burn from departure to destination is based on certain assumed conditions. These include takeoff gross weight, cruise altitude, route of flight, temperature, enroute winds, and cruise speed.

Actual fuel burn should be compared to the flight plan fuel burn throughout the flight.

The planned fuel burn can increase due to:

- temperature above planned
- a lower cruise altitude than planned
- cruise altitude more than 2,000 feet above optimum altitude
- speed faster than planned or appreciably slower than long range cruise speed when long range cruise was planned
- stronger headwind component
- fuel imbalance
- improperly trimmed airplane
- excessive thrust lever adjustments.

Cruise fuel penalties can be approximated using the following guidance. For flight planning purposes, reference the appropriate airplane Flight Planning and Performance Manuals:

- ISA + 10° C: 1% increase in trip fuel
- 2,000 feet above/below optimum altitude: 1% to 2% increase in trip fuel
- 4,000 feet below optimum altitude: 3% to 5% increase in trip fuel
- 8,000 feet below optimum altitude: 8% to 14% increase in trip fuel
- cruise speed 0.01M above LRC: 1% to 2% increase in trip fuel.

For cruise within 2,000 feet of optimum, long range cruise speed can be approximated by using 0.79M. Long range cruise also provides the best buffet margin at all cruise altitudes.

Note: If a discrepancy is discovered between actual fuel burn and flight plan fuel burn that cannot be explained by one of the items above, a fuel leak should be considered. Accomplish the applicable non-normal checklist.

UNCONTROLLED
IF PRINTED

Engine Inoperative Cruise/Driftdown

Execution of a non-normal checklist or sudden engine failure may lead to the requirement to perform an engine inoperative driftdown and diversion to an alternate airport. Engine inoperative cruise information is available from the FMC. An analysis of diversion airport options is available using the FMC ALTN DEST page (as installed).

If an engine failure occurs while at cruise altitude, it may be necessary to descend. The autothrottle should be disconnected and the thrust manually set to CON. On the FMC CRZ page, select the ENG OUT prompt, followed by the prompt corresponding to the failed engine. This displays MOD ENG OUT CRZ (ENG OUT CRZ for FMC U10.3 and later) and the FMC calculates engine out target speed and maximum engine out altitude at the current gross weight. The fields are updated as fuel is burned.

UNCONTROLLED
IF PRINTED

737 NG Flight Crew Training Manual

Set the MAX altitude in the MCP altitude window and the engine out target airspeed in the MCP IAS window. Allow airspeed to slow to engine out speed then engage LVL CHG. If the engine out target airspeed and maximum continuous thrust (MCT) are maintained, the airplane levels off above the original MAX altitude. However, the updated MAX altitude is displayed on the ENG OUT CRZ page. After viewing engine out data, select the ERASE prompt to return to the active CRZ page. With the MOD ENG OUT CRZ (ENG OUT CRZ for FMC U10.3 and later) page selected, no other FMC data pages can be executed.

After level off at the target altitude, maintain MCT and allow the airplane to accelerate to the single engine long range cruise speed. Maintain this speed with manual thrust adjustments. Entering the new cruise altitude and airspeed on the ECON CRZ page updates the ETAs and Top of Descent predictions. Refer to Engine Out Familiarization, Chapter 7, for trim techniques.

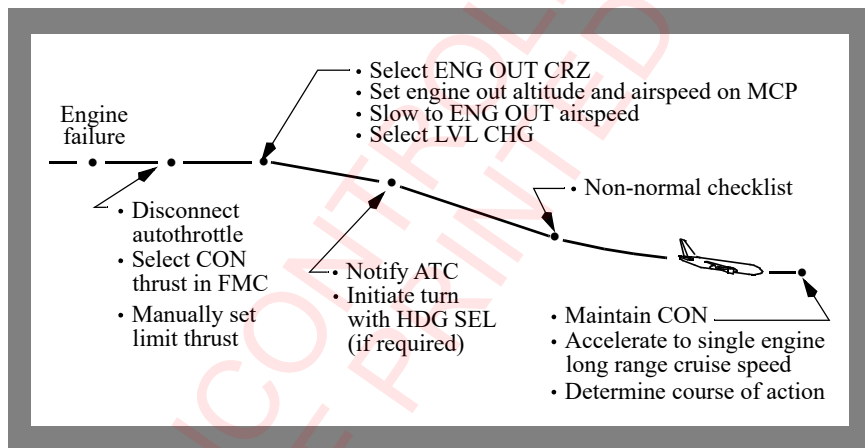

Note: If the airplane is at or below maximum ENG OUT altitude when an engine becomes inoperative, select the MOD ENG OUT CRZ (ENG OUT CRZ for FMC U10.3 and later). Maintain engine out cruise speed using manual thrust adjustments.

In the unlikely event severe engine damage occurs, additional drag associated with severe internal damage or a damaged engine cowl may prevent the airplane from maintaining the FMC calculated engine out cruise altitude. If severe internal engine damage or severe damage to the engine cowl is confirmed or suspected and driftdown is required to reach the intended point of landing, fly the FMC calculated engine out target speed and use MCT on the operating engine. Descend until the airplane is able to maintain altitude at the target speed. Engine Electronic Control logic may allow for additional thrust, if needed, from the operating engine below 15,000 feet pressure altitude and 0.45 Mach by advancing the thrust lever to the forward mechanical stop.

High Altitude High Speed Flight

The airplane exhibits excellent stability throughout the high altitude / high Mach range. Mach buffet is not normally encountered at high Mach cruise. The airplane does not have a Mach tuck tendency.

With Mach trim inoperative, the airplane exhibits a slight nose down trim change when accelerating to speeds approaching MMO, however, control force changes are light and easily managed. When the Mach trim system is operative, the nose down trim change is nearly imperceptible except by referencing the control column position.

As speed nears MMO, drag increases rapidly. At high weights, sufficient thrust may not be available to accelerate to MMO in level flight at normal cruising altitudes.

Flight Control Sensitivity at High Speed and High Altitude

An understanding of flight control sensitivity at high speed and high altitude is necessary for operators of modern day airplanes. There have been reports of passenger injuries due to over-controlling the airplane during high altitude, high airspeed flight when overriding the control column with the autopilot engaged or after disengaging the autopilot with the disconnect switch.

Pilots should understand that, in general, the airplane is significantly more sensitive in pitch response (load factor) to column movement at cruise than it is at lower speeds associated with takeoff and landing. Similarly, for a given pitch attitude change, the change in rate of climb is proportional to the true airspeed. For example, an attitude change at 290 KIAS at sea level that results in a 500 fpm rate of climb would result in approximately a 900 fpm rate if done at 290 KIAS at 35,000 feet. This is because 290 KIAS is equivalent to a TAS of approximately 290 knots at sea level and 490 knots at 35,000 feet. This characteristic is essentially true for small attitude changes, such as the kind used to hold altitude.

Other factors such as gross weight and CG also affect flight control sensitivity and stability, but as long as the CG is in the allowable range the handling qualities will be adequate. However, to avoid over-controlling the flight controls during high altitude high airspeed flight, smooth and small control inputs should be made after disengaging the autopilot.

ETOPS

Extended Operations (ETOPS) for two engine airplanes are those flights which include points at a flying distance greater than one hour (in still air) from an adequate airport, at engine out cruise speed.

ETOPS Requirements and Approval

Appendix A.2.7

The Minimum Equipment List (MEL) and the Dispatch Deviations Guide (DDG) include dispatch relief levels appropriate to ETOPS. Refer to operators procedures and policies for more information on ETOPS requirements.

Flight and Performance

Appendix A.2.7

Crews undertaking ETOPS flights must be familiar with the ETOPS alternate airports listed in the flight plan. These airports must meet ETOPS weather minima which require an incremental increase above conventional alternate minimums at dispatch, and be located so as to ensure that the airplane can divert and land in the event of a system failure requiring a diversion.

Planning an ETOPS flight requires an understanding of the area of operations, critical fuel reserves, altitude capability, cruise performance tables and icing penalties based on the operators approved engine inoperative cruise speed. This information is not included in the FCOM/QRH. Fuel reserve corrections must be made for winds, non-standard atmospheric conditions, performance deterioration caused by engines or airframe, and when needed, flight through forecast icing conditions.

Note: Critical fuel calculations are part of the ETOPS dispatch process and are not normally calculated by the flight crew. The crew normally receives ETOPS critical fuel information in the Computer Flight Plan (CFP).

Procedures

During the last hour of cruise on all ETOPS flights, a fuel crossfeed valve check is done. This verifies that the crossfeed valve is operating so that on the subsequent flight, if an engine fails, fuel is available from both main tanks through the crossfeed valve.

ETOPS engine-out procedures may be different from standard non-normal procedures. Following an engine failure the crew performs a modified driftdown procedure determined by the ETOPS route requirements. This procedure typically uses higher descent and cruise speeds, and a lower cruise altitude following engine failure. This allows the airplane to reach an alternate airport within the specific time limits authorized for the operator. These cruise speeds and altitudes are determined by the operator and approved by its regulatory agency and usually differ from the engine-out speeds provided by the FMC. The captain, however, has the discretion to modify this speed if actual conditions following the diversion decision dictate such a change.

Polar Operations

Appendix A.2.8

Refer to the FMC Polar Navigation section in Volume 2 of the FCOM for specifics about operations in polar regions and a description of the boundaries of the polar regions.

During preflight planning extremely cold air masses should be noted and cold fuel temperatures should be considered. See the Low Fuel Temperature section in this chapter for details regarding recommendations and crew actions.

Due to limited availability of alternate airports relative to other regions, special attention should be given to diversion planning including airport conditions and availability of compatible fuel. Crews should be prepared to operate in QFE and metric altitude where required. Expect changes in assigned cruising levels enroute since standard cruising levels vary by FIR. Some airports provide QNH upon request, even if their standard is QFE. Metric wind speed (m/sec) may be all that is available. A simple approximation: 1 m/sec = 2 knots. A feet to meters conversion chart may be useful for planning step climbs, converting minima, etc.

Use caution when using ADF and/or VOR raw data. ADF orientation (true or magnetic) is determined by the heading reference selected by the crew. VOR radials are displayed according to the orientation of the VOR station.

Communications should be handled according to the applicable enroute charts. Above 82 degrees N, SATCOM is unavailable. HF frequencies and HF SELCAL must be arranged by the flight crew prior to the end of SATCOM coverage. Routine company communications procedures should include flight following to enable immediate assistance during a diversion or other emergency.

Note: To use SATCOM on the ground, the ADIRU must be aligned.

When navigating in the polar regions, magnetic heading should be considered unreliable or totally useless for navigation. Magnetic variations typically are extreme, often are not constant at the same point and change rapidly as airplane position changes. Ensure the computer flight plan shows true tracks and true headings. Grid headings may also be used as a reference for those airplanes equipped with grid heading indicators although no airplane systems use grid heading. For some high latitude airports, grid headings are shown on the instrument approach procedures. Note that unmapped areas in the GPWS terrain database display as magenta dots on the map, regardless of the airplane altitude.

The primary roll mode for polar operations should be LNAV, which may be used with the heading reference switch in the NORM position (as installed). HDG SEL/HOLD are functional but require the manual selection of TRUE heading reference. Deviations from planned route may be accomplished in HDG SEL.

Note: Do not use HDG SEL or ROLL CWS north of 89 degrees 30 minutes North latitude or south of 89 degrees 30 minutes South latitude, due to rapid heading and track changes occurring near either pole. At latitudes north of N85 or south of S85, the true heading on the RMI may differ from the True Heading displayed on the MAP, due to position differences between IRU-L and FMC.

Loss of both GPS units or loss of GPS updating results in an increased ANP and possible display of the UNABLE REQD NAV PERF-RNP message, but normally does not prevent continuing the polar flight.

If neither IRU is operating in the NAV mode, the airplane heading/track on the PFD and map is invalid. The GPS-L True Track on CDU PROGRESS page provides a source of airplane track, which can be used as a secondary reference to update the heading for any IRS in ATT mode.

UNCONTINUED
IF PRINTED

Descent

Descent Speed Determination

The default FMC descent speed schedule is an economy (ECON) descent from cruise altitude to the airport speed transition altitude. At the airport speed transition altitude, the airspeed is reduced to the airport speed restriction speed in the navigation database minus 10 knots. The speed schedule is adjusted to accommodate waypoint speed/altitude constraints displayed on the LEGS pages, and speed/altitude constraints displayed on the DES page. If desired, the ECON speed schedule can be modified by alternate Mach, Mach/IAS, or IAS values on the DES page target speed line. If the FMC information is not available, use target speeds from the Descent Rates table in this chapter.

Descent Path

An FMC path descent is the most economical descent method. At least one waypoint-related altitude constraint below cruise altitude on a LEGS page generates a descent guidance path. The path is built from the lowest constraint upward, assuming idle thrust, or approach idle below the anti-ice altitude entered on the DESCENT FORECAST page.

The path is based on the descent speed schedule, any entered speed/altitude constraints or forecast use of anti-ice. The path reflects descent wind values entered on the DESCENT FORECAST page.

Descent Constraints

Descent constraints may be automatically entered in the route when selecting an arrival procedure, or manually entered through the CDU.

Normally, set all mandatory altitude restrictions and “at or above” constraints in the MCP altitude window. The next altitude may be set when the restriction has been assured or further clearance has been received. This procedure provides altitude alerting and ensures compliance with altitude clearance limits.

When using VNAV, if altitude constraints are closely spaced to the extent that crew workload is adversely affected and unwanted level-offs are a concern, the alternate MCP altitude setting technique can be used with operator approval. Refer to Chapter 1, MCP Altitude Setting Techniques Using VNAV for more information on this subject.

Note: When the alternate MCP altitude setting technique using VNAV is used, the selection of a pitch mode other than VNAV PTH or VNAV SPD for descent will result in a risk of violating altitude constraints.

For descents in pitch modes other than VNAV PTH or VNAV SPD, the MCP altitude must be set at the next altitude constraint, or as published in the FCOM for an instrument approach.

Shallow vertical path segments may result in the autothrottle supplying partial thrust to maintain the target speed. Vertical path segments steeper than an idle descent may require the use of speedbrakes for speed control. Deceleration requirements below cruise altitude (such as at 10,000 MSL) are accomplished based on a rate of descent of approximately 500 fpm. When a deceleration is required at top of descent, it is performed in level flight.

Speed Intervention (As installed)

VNAV speed intervention can be used to respond to ATC speed change requirements. VNAV SPD pitch mode responds to speed intervention by changing airplane pitch while the thrust remains at idle. VNAV PTH pitch mode may require the use of speedbrakes or increased thrust to maintain the desired airspeed.

Descent Preparation Using HUD System

If the combiner was previously stowed, the combiner should be positioned and the pilot should verify that it is properly aligned with the overhead unit. For night landings, set combiner brightness high enough to ensure that the symbology is visible over bright touchdown zone lights.

Descent Planning

Flight deck workload typically increases as the airplane descends into the terminal area. Distractions must be minimized and administrative and nonessential duties completed before descent or postponed until after landing. Perform essential duties early in the descent so more time is available during the critical approach and landing phases.

Operational factors and/or terminal area requirements may not allow following the optimum descent schedule. Terminal area requirements can be incorporated into basic flight planning but ATC, weather, icing and other traffic may require adjustments to the planned descent schedule.

Proper descent planning is necessary to arrive at the desired altitude at the proper speed and configuration. The distance required for the descent is approximately 3 NM/1,000 feet altitude loss for no wind conditions using ECON speed. Rate of descent is dependent upon thrust, drag, airspeed schedule and gross weight.

Descent Rates

Descent Rate tables provide typical rates of descent below 20,000 feet with idle thrust and speedbrakes extended or retracted. The effect of winglets on the rate of descent is negligible. These rates apply to airplanes with and without winglets.

Target Speed	Rate of Descent (Typical)	
	Clean	With Speedbrake (with or without load alleviation)
0.78M / 280 knots	2200 fpm	3100 fpm
250 knots	1700 fpm	2300 fpm
VREF 40 + 70 knots	1100 fpm	1400 fpm

Normally, descend with idle thrust and in clean configuration (no speedbrakes). Maintain cruise altitude until the proper distance or time out for the planned descent and then hold the selected airspeed schedule during descent. Deviations from this schedule may result in arriving too high at destination and require circling to descend, or arriving too low and far out requiring extra time and fuel to reach destination.

The speedbrake may be used to correct the descent profile if arriving too high or too fast. The Descent Procedure is normally initiated before the airplane descends below the cruise altitude for arrival at destination, and should be completed by 10,000 feet MSL. The Approach Procedure is normally started at transition level.

Plan the descent to arrive at traffic pattern altitude at flaps up maneuver speed approximately 12 miles from the runway when proceeding straight-in or about 8 miles from the runway when making an abeam approach. A good crosscheck is to be at 10,000 feet AGL, 30 miles from the airport, at 250 knots.

Losing airspeed can be difficult and may require a level flight segment. For planning purposes, it requires approximately 25 seconds and 2 NM to decelerate from 280 to 250 knots in level flight without speedbrakes. It requires an additional 35 seconds and 3 NM to decelerate to flaps up maneuver speed at average gross weights. Using speedbrakes to aid in deceleration reduces these times and distances by approximately 50%.

Maintaining the desired descent profile and using the map mode to maintain awareness of position ensures a more efficient operation. Maintain awareness of the destination weather and traffic conditions, and consider the requirements of a potential diversion. Review the airport approach charts and discuss the plan for the approach, landing, and taxi routing to parking. Complete the approach briefing as soon as practical, preferably before arriving at top of descent. This allows full attention to be given to airplane control.

Speedbrakes

The PF should keep a hand on the speedbrake lever when the speedbrakes are used in-flight. This helps prevent leaving the speedbrake extended when no longer required.

Use of speedbrakes between the down detent and flight detent can result in rapid roll rates and normally should be avoided. While using the speedbrakes in descent, allow sufficient altitude and airspeed margin to level off smoothly. Lower the speedbrakes before adding thrust.

Note: In flight, do not extend the speedbrake lever beyond the FLIGHT detent.

The use of speedbrakes with flaps extended should be avoided, if possible. With flaps 15 or greater, the speedbrakes should be retracted. If circumstances dictate the use of speedbrakes with flaps extended, high sink rates during the approach should be avoided. Speedbrakes should be retracted before reaching 1,000 feet AGL.

The flaps are normally not used for increasing the descent rate. Normal descents are made in the clean configuration to pattern or instrument approach altitude.

When descending with the autopilot engaged and the speedbrakes extended at speeds near VMO/MMO, the airspeed may momentarily increase to above VMO/MMO if the speedbrakes are retracted quickly. To avoid this condition, smoothly and slowly retract the speedbrakes to allow the autopilot sufficient time to adjust the pitch attitude to maintain the airspeed within limits.

When the speedbrakes are retracted during altitude capture near VMO/MMO, a momentary overspeed condition may occur. This is because the autopilot captures the selected altitude smoothly by maintaining a fixed path while the thrust is at or near idle. To avoid this condition, it may be necessary to reduce the selected speed and/or descent rate prior to altitude capture or reduce the selected speed and delay speedbrake retraction until thrust is increased to maintain level off airspeed.

Flaps and Landing Gear

Normal descents are made in the clean configuration to pattern or instrument approach altitude. If greater descent rates are desired, extend the speedbrakes. When thrust requirements for anti-icing result in less than normal descent rates with speedbrakes extended, or if higher than normal descent rates are required by ATC clearance, the landing gear can be lowered to increase the rate of descent.

Extend the flaps when in the terminal area and conditions require a reduction in airspeed below flaps up maneuver speed. Normally select flaps 5 prior to the approach fix going outbound, or just before entering downwind on a visual approach.

Note: Avoid using the landing gear for increased drag. This minimizes passenger discomfort and increases gear door life.

Speed Restrictions

Speed restrictions below specific altitudes/flight levels and in the vicinity of airports are common. At high gross weights, minimum maneuver speed may exceed these limits. Consider extending the flaps to attain a lower maneuver speed or obtain clearance for a higher airspeed from ATC.

Other speeds may be assigned by ATC. Pilots complying with speed adjustments are expected to maintain the speed within plus or minus 10 knots.

Engine Icing During Descent

The use of anti-ice and the increased thrust required increases the descent distance. Therefore, proper descent planning is necessary to arrive at the initial approach fix at the correct altitude, speed, and configuration. The anticipated anti-ice use altitude should be entered on the DESCENT FORECAST page to assist the FMC in computing a more accurate descent profile.

Engine icing may form when not expected and may occur when there is no evidence of icing on the windshield or other parts of the airplane. Once ice starts to form, accumulation can build very rapidly. Although one bank of clouds may not cause icing, another bank, which is similar, may induce icing.

Note: The engine anti-icing system should be turned on whenever icing conditions exist or are anticipated. Failure to follow the recommended anti-ice procedures can result in engine stall, overtemperature or engine damage.

Holding

Start reducing to holding airspeed 3 minutes before arrival time at the holding fix so that the airplane crosses the fix, initially, at or below the maximum holding airspeed.

If the FMC holding speed is greater than the ICAO or FAA maximum holding speed, holding may be conducted at flaps 1, using flaps 1 maneuver speed. Flaps 1 uses approximately 10% more fuel than flaps up. Holding speeds in the FMC provide an optimum holding speed based upon fuel burn and speed capability; but are never lower than flaps up maneuver speed.

Maintain clean configuration if holding in icing conditions or in turbulence.

If the holding pattern has not been programmed in the FMC, the initial outbound leg should be flown for 1 minute when at or below 14,000 feet or 1 1/2 minutes when above 14,000 feet or as required by the regulatory authority. Timing for subsequent outbound legs should be adjusted as necessary to achieve proper inbound leg timing.

In extreme wind conditions or at high holding speeds, the defined holding pattern protected airspace may be exceeded. However, the holding pattern depicted on the map display will not exceed the limits.

Holding Airspeeds

Advise ATC if an increase in airspeed is necessary due to turbulence, if unable to accomplish any part of the holding procedure, or if unable to comply with speeds listed in the following tables.

ICAO Holding Airspeeds (Maximum)

Altitude	Speed
Through 14,000 feet	230 knots
Above 14,000 to 20,000 feet MSL	240 knots
Above 20,000 to 34,000 feet MSL	265 knots
Above 34,000 feet MSL	0.83M

FAA Holding Airspeeds (Maximum)

Altitude	Speed
Through 6,000 feet MSL	200 knots
6,001 feet MSL through 14,000 feet MSL	230 knots (May be restricted to an airspeed of 210 KIAS. This non-standard pattern will be identified by an icon.)
14,001 feet MSL and above	265 knots

Procedure Holding

When a procedure holding pattern is selected from the navigation database and the FMC shows PROC HOLD on the legs page, the following is true when the PROC HOLD is the active leg:

- exiting the holding pattern is automatic; there is no need to select EXIT HOLD
- if the crew desires to remain in holding a new holding pattern must be entered.

Holding Airspeeds Not Available from the FMC

If holding speed is not available from the FMC, refer to the PI chapter in the FCOM. If time does not permit immediate reference to the FCOM, the following speed schedule may be used temporarily. This simplified holding speed schedule may not match the FMC or FCOM holding speeds because the FMC and FCOM holding speeds are based on many conditions that cannot be generalized into a simple schedule. However, this schedule provides a reasonable approximation of minimum fuel burn speed with appropriate margins to initial buffet.

Recommended holding speeds can be approximated by using the following guidance until more accurate speeds are obtained from the FCOM:

- flaps up maneuver speed approximates minimum fuel burn speed and may be used at low altitudes
- above FL250, use VREF 40 + 100 knots to provide at least a 0.3 g margin to initial buffet (full maneuver capability).

UNCONTROLLED
IF PRINTED

Intentionally
Blank

UNCONTROLLED
IF PRINTED



Approach and Missed Approach

Chapter 5

Table of Contents

Section TOC

Preface 5.1

Approach 5.1

 Instrument Approaches 5.1

 Approach Briefing 5.2

 Approach Category 5.3

 Obstruction Clearance for a Circling Approach 5.3

 Approach Clearance 5.4

 Procedure Turn 5.4

 Stabilized Approach Recommendations 5.4

 Mandatory Missed Approach 5.6

 Landing Minima 5.7

 Radio Altimeter 5.7

Flap Configurations for Approach and Landing. 5.7

 Flap Setting for Landing 5.8

 Flap Extension 5.8

 Maneuver Margin 5.8

Missed Approach Point 5.9

 Determination of a MAP 5.9

 Instrument Landing System or GBAS Landing System 5.9

 Instrument Approach using VNAV, IAN or V/S 5.10

 Localizer 5.10

 Other Non-ILS Approaches. 5.10

 Precision Approach Radar. 5.10

 Airport Surveillance Radar 5.10

ILS or GLS Approach 5.10

 Fail Operational. 5.11

 Fail Passive 5.11

ILS or GLS Approach - Fail Passive	5.12
ILS or GLS Approach - Fail Operational	5.13
Decision Altitude or Height - DA(H)	5.14
Alert Height - AH	5.14
Procedure Turn and Initial Approach	5.14
Approach	5.14
Decision Altitude or Height - DA(H)	5.19
Raw Data - (No Flight Director)	5.19
AFDS Autoland Capabilities	5.20
Low Visibility Approaches	5.22
AFDS Faults	5.24
Fail Passive vs. Fail Operational Autoflight System	5.25
ILS Approach - Landing Geometry	5.28
Non-Normal Operations	5.29
GLS Approach (As installed)	5.32
Non - ILS Instrument Approaches	5.34
Non - ILS Instrument Approaches - General	5.34
Procedure Turn and Initial Approach	5.43
Vertical Path Construction	5.43
Instrument Approach Using VNAV	5.46
Instrument Approach Using IAN	5.52
Instrument Approach Using V/S	5.58
Instrument Approach - RNAV (RNP) AR	5.62
Visual Descent Point	5.66
Missed Approach - Non-ILS	5.67
Circling Approach	5.68
Circling Approach - General	5.69
Obstruction Clearance	5.70
Circling Approach - One Engine Inoperative	5.72
Missed Approach - Circling	5.72

737 NG Flight Crew Training Manual

Visual Traffic Pattern	5.74
Visual Approach - General	5.75
Thrust	5.75
Downwind and Base Leg	5.75
Final Approach	5.75
Engine Failure On Final Approach	5.76
Touch and Go Landings.	5.77
Touch and Go Landing - General	5.78
Approach	5.78
Landing	5.78
Stop and Go Landings	5.78
Go-Around and Missed Approach - All Approaches (FMC U10.6 and earlier)	5.80
Go-Around and Missed Approach - All Approaches (FMC 10.7 and later)	5.81
Go-Around and Missed Approach - All Engines Operating	5.82
Low Altitude Level Off - Low Gross Weight	5.84
Go-Around after Touchdown	5.84
Go-Around and Missed Approach - One Engine Inoperative	5.85
Engine Failure During Go-Around and Missed Approach	5.85



Intentionally
Blank

UNCONTROLLED
IF PRINTED



Preface

This chapter outlines recommended operating practices and techniques for ILS, GLS (as installed), non-ILS/GLS, circling and visual approaches, and the Go-Around and Missed Approach maneuver. Flight profile illustrations represent the recommended basic configuration for normal and non-normal flight maneuvers and provide a basis for standardization and crew coordination.

The maneuvers are normally accomplished as illustrated. However, due to conflicting traffic at training airports, air traffic separation requirements, and radar vectors, modifications may be necessary. Conditions beyond the control of the flight crew may preclude following an illustrated maneuver exactly. The maneuver profiles are not intended to replace good judgment and logic.

Approach

Instrument Approaches

All safe instrument approaches have certain basic factors in common. These include good descent planning, careful review of the approach procedure, accurate flying, and good crew coordination. Thorough planning is the key to a safe, unhurried, professional approach.

Ensure the waypoint sequence on the LEGS page, altitude and speed restrictions, and the map display reflect the air traffic clearance. Last minute air traffic changes or constraints may be managed by appropriate use of the MCP heading, altitude and airspeed selectors. Updating the waypoint sequence on the LEGS page should be accomplished only as time permits.

Complete the approach preparations before arrival in the terminal area. Set decision altitude or height DA(H), or minimum descent altitude or height MDA(H). Crosscheck radio and pressure altimeters whenever practical. Do not completely abandon enroute navigation procedures even though air traffic is providing radar vectors to the initial or final approach fix. Check ADF/VOR selector set to the proper position. Verify ILS, GLS, VOR and ADF are tuned and identified if required for the approach.

Note: The requirement to tune and identify nav aids can be satisfied by confirming that the tuned nav aid frequency is replaced by the correct alphabetical identifier on the PFD/ND (as installed) or by aurally identifying the nav aid.

Check that the marker beacon is selected on the audio panel, if needed. The course and glide slope signals are reliable only when their warning flags are not displayed, localizer and glide slope pointers are in view, and the ILS or GLS identifier is received. Confirm the published approach inbound course is set or displayed.

Do not use radio navigation aid facilities that are out of service even though flight deck indications appear normal. Radio navigation aids that are out of service may have erroneous transmissions that are not detected by airplane receivers and no flight deck warning is provided to the crew.

Approach Briefing

Before the start of an instrument approach, the PF should brief the PM of his intentions in conducting the approach. Both pilots should review the approach procedure. All pertinent approach information, including minimums and missed approach procedures, should be reviewed and alternate courses of action considered.

As a guide, the approach briefing should include at least the following:

- weather and NOTAMS at destination and alternate, as applicable
- type of approach and the validity of the charts to be used
- navigation and communication frequencies to be used
- minimum safe sector altitudes for that airport
- approach procedure including courses and heading
- vertical profile including all minimum altitudes, crossing altitudes and approach minimums
- speed restrictions
- determination of the Missed Approach Point (MAP) and the missed approach procedure
- landing distance required for current conditions compared to landing distance available
- other related crew actions such as tuning of radios, setting of course information, or other special requirements
- taxi routing to parking
- any appropriate information related to a non-normal procedure, including non-normal configuration landing distance required versus landing distance available
- management of AFDS.

Approach Category

Appendix A.2.8

An aircraft approach category is used for straight-in approaches. The designated approach category for an aircraft is defined using the maximum certified landing weight as listed in the AFM. Under FAA criteria, the speed used to determine the approach category is the landing reference speed (VREF). ICAO and other regulatory agencies may use different criteria.

737-800 - 737-900ER

Airplanes are classified in one of two categories depending upon the operator's maximum certified landing weight. The category used is determined by the operator in coordination with the applicable regulatory authority.

Category	IAS
C	121 knots or more but less than 141 knots
D	141 knots or more but less than 166 knots

Note: An airplane's approach category does not change if the actual landing weight is less than the maximum certificated landing weight. The certified approach category is permanent and independent of the changing conditions of day-to-day operations.

Under FAA criteria:

737-600, 737-700

- the 737-600 and -700 airplanes are classified as Category "C" airplanes.

737-800 - 737-900ER

- the 737-800 and 737-900 series airplanes are classified as Category "C" or "D" airplanes, depending upon the maximum landing weight.

Obstruction Clearance for a Circling Approach

For circling approaches, maximum airplane speeds are shown on the approach plate instead of airplane approach categories. Circling approach minimums for both FAA and ICAO criteria are based on obstruction clearance for approach maneuvering within a defined region of airspace. This region of airspace is determined by maximum IAS. This region gets larger with higher speed, which may result in higher approach minimums depending on the terrain characteristics surrounding the airport. Similarly, lower airspeed may result in a lower approach minimum. See the section titled Circling Approach later in this chapter for more information on obstruction clearance.

Approach Clearance

When cleared for an approach and on a published segment of that approach, the pilot is authorized to descend to the minimum altitude for that segment. When cleared for an approach and not on a published segment of the approach, maintain assigned altitude until crossing the initial approach fix or established on a published segment of that approach. If established in a holding pattern at the final approach fix, the pilot is authorized to descend to the procedure turn altitude when cleared for the approach.

If using a VNAV path, all altitude and speed constraints must be entered either manually, by selecting a published arrival, or by a combination of both. When properly entered, the VNAV path profile complies with all altitude and airspeed constraints. Crossing altitudes may be higher than the minimum altitudes for that segment because the VNAV path is designed to optimize descent profiles.

When conducting an instrument approach from the holding pattern, continue on the same pattern as holding, extend flaps to 5 on the outbound track parallel to final approach course. Turn inbound on the procedure turn heading. This type of approach is also referred to as a race track approach.

Procedure Turn

On most approaches the procedure turn must be completed within specified limits, such as within 10 NM of the procedure turn fix or beacon. The FMC depicted procedure turn, or holding pattern in lieu of procedure turn, complies with airspace limits. The published procedure turn altitudes are normally minimum altitudes.

The FMC constructs the procedure turn path based upon predicted winds, a 170 knot airspeed and the “excursion” distance in the nav database for the procedure.

Adjust time outbound for airspeed, wind effects, and location of the procedure turn fix. If the procedure turn fix is crossed at an excessively high ground speed, the procedure turn protected airspace may be exceeded. The procedure turn should be monitored using the map to assure the airplane remains within protected airspace.

Stabilized Approach Recommendations

Maintaining a stable speed, descent rate, and vertical/lateral flight path in landing configuration is commonly referred to as the stabilized approach concept.

Any significant deviation from planned flight path, airspeed, or descent rate should be announced. The decision to execute a go-around is not an indication of poor performance.

Note: Do not attempt to land from an unstable approach.

737 NG Flight Crew Training Manual

Recommended Elements of a Stabilized Approach

The following recommendations are consistent with criteria developed by the Flight Safety Foundation.

All approaches should be stabilized by 1,000 feet AFE in instrument meteorological conditions (IMC) and by 500 feet AFE in visual meteorological conditions (VMC). An approach is considered stabilized when all of the following criteria are met:

- the airplane is on the correct flight path
- only small changes in heading and pitch are required to maintain the correct flight path
- the airplane should be at approach speed. Deviations of +10 knots to – 5 knots are acceptable if the airspeed is trending toward approach speed
- the airplane is in the correct landing configuration
- sink rate is no greater than 1,000 fpm; if an approach requires a sink rate greater than 1,000 fpm, a special briefing should be conducted
- thrust setting is appropriate for the airplane configuration
- all briefings and checklists have been conducted.

Specific types of approaches are stabilized if they also fulfill the following:

- ILS and GLS approaches should be flown within one dot of the glide slope and localizer, or within the expanded localizer scale
- approaches using IAN should be flown within one dot of the glide path and FAC
- during a circling approach, wings should be level on final when the airplane reaches 300 feet AFE.

Unique approach procedures or abnormal conditions requiring a deviation from the above elements of a stabilized approach require a special briefing.

Note: An approach that becomes unstabilized below 1,000 feet AFE in IMC or below 500 feet AFE in VMC requires an immediate go-around.

These conditions should be maintained throughout the rest of the approach for it to be considered a stabilized approach. If the above criteria cannot be established and maintained until approaching the flare, initiate a go-around.

At 100 feet HAT for all visual approaches, the airplane should be positioned so the flight deck is within, and tracking to remain within, the lateral confines of the runway edges extended.

As the airplane crosses the runway threshold it should be:

- stabilized on approach airspeed to within + 10 knots until arresting descent rate at flare
- on a stabilized flight path using normal maneuvering
- positioned to make a normal landing in the touchdown zone (the first 3,000 feet or first third of the runway, whichever is less).

Initiate a go-around if the above criteria cannot be maintained.

Maneuvering (including runway changes and circling)

When maneuvering below 500 feet, be cautious of the following:

- descent rate change to acquire glide path
- lateral displacement from the runway centerline
- tailwind or crosswind components
- runway length available.

Mandatory Missed Approach

On all instrument approaches, where suitable visual reference has not been established and maintained, execute an immediate missed approach when:

- a navigation radio or flight instrument failure occurs which affects the ability to safely complete the approach
- the navigation instruments show significant disagreement
- on ILS or GLS final approach and either the localizer or the glide slope indicator shows full deflection
- on IAN final approach and either the FAC pointer or the glide path pointer shows full deflection
- on an RNP based approach and an alert message indicates that ANP exceeds RNP
- for airplanes with NPS, during RNP approach operation, anytime the NPS deviation exceeds the limit or an amber deviation alert occurs unless the aircrew is able to change to a non-RNP procedure
- for airplanes with FMC U14 or later, during RNP AR approaches, with or without NPS, anytime the UNABLE REQD NAV PERF-RNP is shown during the approach, regardless of whether or not the lateral or vertical RNP are exceeded
- for airplanes without NPS, during RNP approach operation, anytime the XTK exceeds 1.0 X RNP unless the aircrew is able to change to a non-RNP procedure.
- on a radar approach and radio communication is lost.

Landing Minima

Most regulatory agencies require visibility for landing minima. Ceilings are not required. There are limits on how far an airplane can descend without visual contact with the runway environment when making an approach. Descent limits are based on a decision altitude or height DA(H) for approaches using a glide slope or certain approaches using a VNAV path; or a MDA(H) for approaches that do not use vertical guidance, or where a DA(H) is not authorized for use. Most agencies do not require specific visual references below alert height (AH).

Approach charts use the abbreviation DA(H) or MDA(H). DA(H) applies to Category I, II, and certain fail passive Category III operations. A decision altitude “DA” or minimum descent altitude “MDA” is referenced to MSL and the parenthetical height “(H)” is referenced to Touchdown Zone Elevation (TDZE) or threshold elevation. Example: A DA(H) of 1,440’ (200’) is a DA of 1,440’ with a corresponding height above the touchdown zone of 200’.

When RVR is reported for the landing runway, it typically is used in lieu of the reported meteorological visibility.

Radio Altimeter

A Radio Altimeter (RA) is normally used to determine DH when a DA(H) is specified for Category II or Category III approaches, or to determine alert height (AH) for Category III approaches. Procedures at airports with irregular terrain may use a marker beacon instead of a DH to determine the missed approach point. The radio altimeter may also be used to crosscheck the primary altimeter over known terrain in the terminal area. However, unless specifically authorized, the radio altimeter is not used for determining MDA(H) on instrument approaches. It should also not be used for approaches where use of the radio altimeter is not authorized (RA NOT AUTHORIZED). However, if the radio altimeter is used as a safety backup, it should be discussed in the approach briefing.

Flap Configurations for Approach and Landing

During maneuvering for an approach, when the situation dictates an earlier than normal speed reduction, the use of flaps 10 with the gear up is acceptable.

Flap Setting for Landing

For normal landings, use flaps 15, 30, or flaps 40. Flaps 15 is normally limited to airports where approach climb performance is a factor. Flaps 30 provides better noise abatement and reduced flap wear/loads. When performance criteria are met, use flaps 40 to minimize landing speed, and landing distance.

Note: Normal landings using flaps 15 are permitted for authorized operators with appropriate performance data available.

Note: Runway length and condition must be taken into account when selecting a landing flap position.

Flap Extension

During flap extension, selection of the flaps to the next flap position should be made when approaching, and before decelerating below, the maneuver speed for the existing flap position. The flap extension speed schedule varies with airplane weight and provides full maneuver capability or at least 40° of bank (25° of bank and 15° overshoot) to stick shaker at all weights.

Note: If the maneuver speed for the next flap setting is below VREF + wind additive, select the next flap position when approaching the VREF + wind additive speed. Maintain the VREF + wind additive speed rather than slowing to the maneuver speed for the selected flap setting.

Flap Extension Schedule

Current Flap Position	At Speedtape "Display"	Select Flaps	Command Speed for Selected Flaps
UP	"UP"	1	"1"
1	"1"	5	"5"
5	"5"	15	"15"
15	"15"	30 or 40	(Vref 30 or Vref 40) plus wind additives

Maneuver Margin

Flight profiles should be flown at, or slightly above, the recommended maneuver speed for the existing flap configuration. These speeds approximate maximum fuel economy and allow full maneuvering capability (25° bank with a 15° overshoot).

737 NG Flight Crew Training Manual

Full maneuver margin exists for all normal landing procedures whenever speed is at or above the maneuver speed for the current flap setting. At least adequate maneuver margin exists with flaps 15 at VREF 30 + 5 knots or VREF 40 + 5 knots during a go-around at go-around thrust.

Airspeeds recommended for non-normal flight profiles are intended to restore near normal maneuvering margins and/or aerodynamic control response.

The configuration changes are based on maintaining full maneuvering and/or maximum performance unless specified differently in individual procedures. It is necessary to apply wind additives to the VREF speeds. See the Command Speed section in Chapter 1 for an explanation of wind additives.

Missed Approach Point

A Missed Approach Point (MAP) is a point where a missed approach must be initiated if suitable visual references are not available to make a safe landing or the airplane is not in a position to make a safe landing.

Determination of a MAP

For approaches such as ILS or GLS, the DA(H) in conjunction with the glide slope is used to determine the MAP. For non-ILS/GLS or G/S out approaches, two methods for determining the MAP are acceptable in lieu of timing due to the accuracy of FMC positioning:

- when arriving at the DA(H) or MDA(H) in conjunction with a VNAV path
- if not using a VNAV path, use of the map display to determine when the airplane has reached the VDP or the MAP. The approach legs along with distance and time to the missed approach waypoint are displayed on the map.

Timing During Approaches

Since FMC use is appropriate for instrument approach navigation, timing is not the primary means to determine the missed approach point. The probability of multiple failures that would result in timing being the only method of determining the missed approach point is remote. However, some regulatory agencies may still require the use of timing for approaches. The timing table, when included, shows the distance from the final approach fix to the MAP.

Timing for instrument approaches is not necessary as long as there is no UNABLE REQD NAV PERF - RNP alert displayed.

Instrument Landing System or GBAS Landing System

Arrival at the MAP is determined by reference to an altimeter. DA is determined by reference to the barometric altimeter, while DH is determined by reference to the radio altimeter.

Instrument Approach using VNAV, IAN or V/S

When specifically authorized by the appropriate regulatory authority, non-ILS approaches may be flown to the following minima:

- a published VNAV DA(H)
- a published MDA(H) used as a decision altitude.

If not specifically authorized to use the MDA(H) as a DA(H), use the MDA(H) specified for the instrument procedure being flown.

Localizer

For most localizer approaches, the published MAP is the threshold of the runway. However, if a localizer approach is flown in VNAV PTH, use the missed approach criteria described in the Instrument Approach using VNAV or IAN (as installed) section in this chapter.

Other Non-ILS Approaches

The MAP for all other non-ILS approaches is depicted on the approach chart. If the procedure has a final approach fix, the MAP may be short of the runway threshold, at the runway threshold, or located over a radio facility on the field. For on airport facilities (VOR or NDB) which do not have a final approach fix, the facility itself is the MAP and in most cases is beyond the runway threshold. Do not assume the airplane will always be in a position to make a normal landing when reaching the MDA(H) before reaching the MAP. When the MAP is at or beyond the runway threshold, the airplane must reach MDA(H) before arrival at the MAP if a normal final approach is to be made.

Precision Approach Radar

The MAP for a Precision Approach Radar (PAR) approach is the geographic point where the glide path intersects the DA(H). Arrival at the MAP is determined by the pilot using the altimeter or as observed by the radar controller, whichever occurs first.

Airport Surveillance Radar

During an Airport Surveillance Radar (ASR) approach, the radar controller is required to discontinue approach guidance when the airplane is at the MAP or one NM from the runway, whichever is greater. Perform the missed approach when instructed by the controller.

ILS or GLS Approach

The approach flight pattern assumes all preparations for the approach such as review of approach procedure, setting of minima, inbound course and radios are complete. It focuses on crew actions and avionics systems information. It also includes unique considerations during low weather minima operations. The flight pattern may be modified to suit local traffic and air traffic requirements.

Boeing Proprietary. Copyright © Boeing. May be subject to export restrictions under EAR. See title page for details.

737 NG Flight Crew Training Manual

The recommended operating practices and techniques in this section apply to both ILS and GLS approaches. Except for station tuning, pilot actions are identical. A sub-section titled GLS Approach containing information specific to the GLS is located at the end of this section.

Fail Operational

Fail operational refers to an AFDS capable of completing an ILS approach, autoland, and rollout following the failure of any single system component after passing alert height.

Fail Passive

Fail passive refers to an AFDS which in the event of a failure, causes no significant deviation of airplane flight path or attitude. A DA(H) is used as approach minimums.

UNCONTROLLED
IF PRINTED

ILS or GLS Approach - Fail Passive

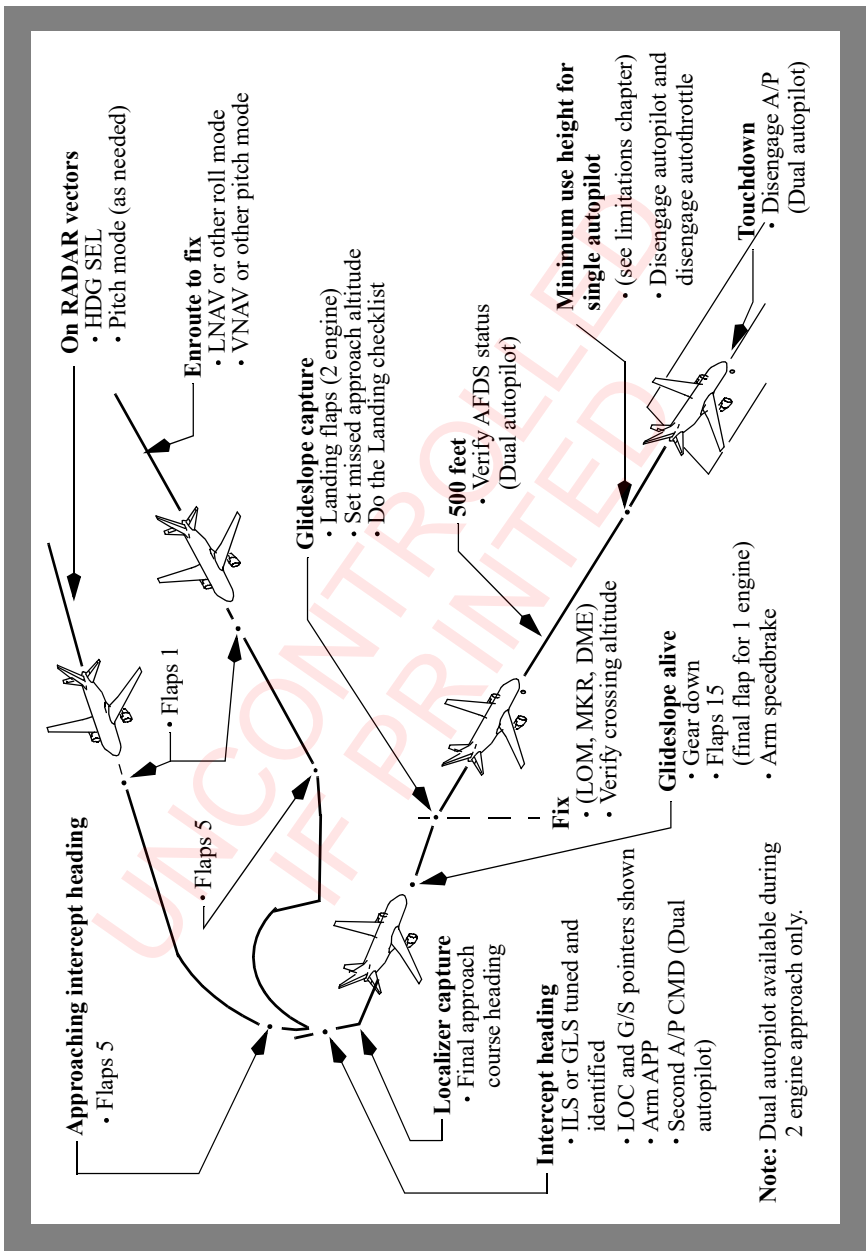

ILS or GLS Approach - Fail Operational

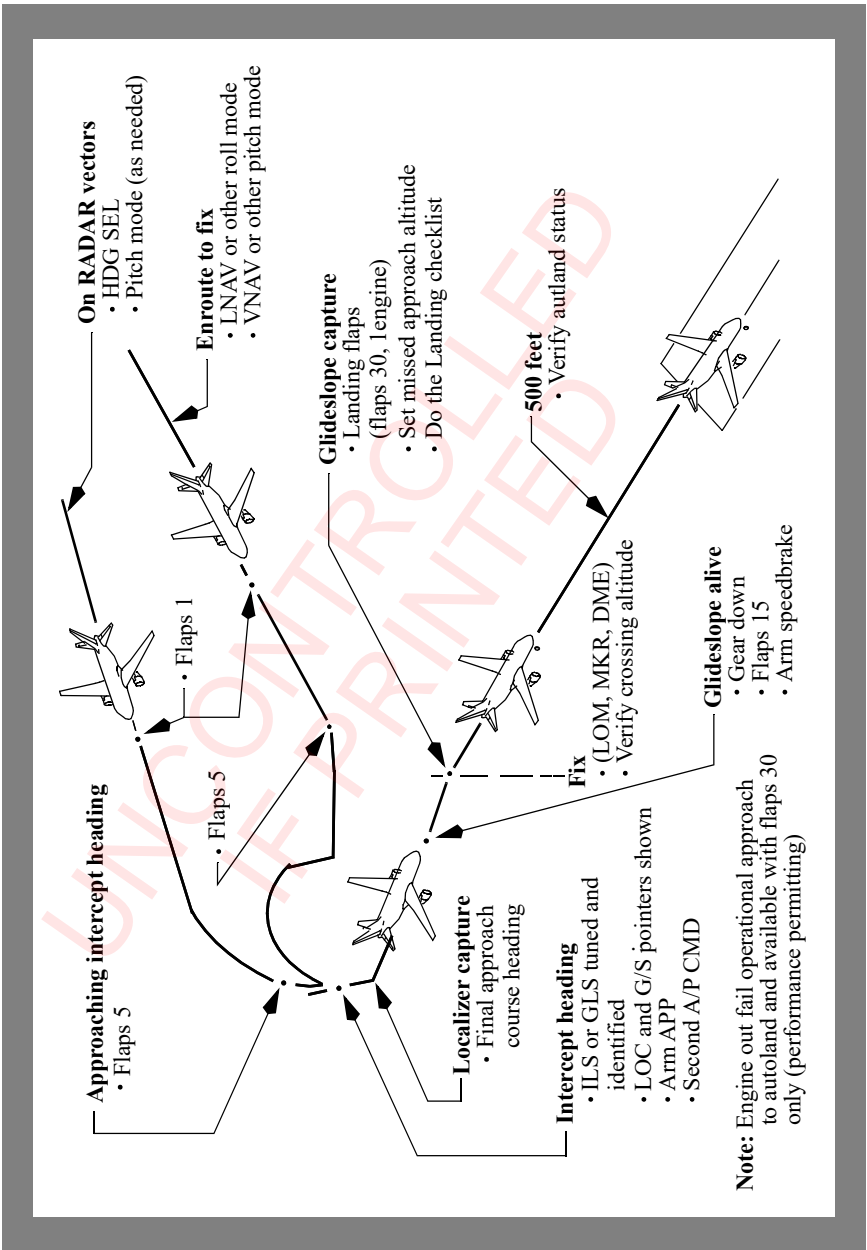

Decision Altitude or Height - DA(H)

A Decision Altitude or Height is a specified altitude or height in an ILS, GLS, PAR, or some approaches using a VNAV path or IAN where a missed approach must be initiated if the required visual reference to continue the approach has not been established. The “Altitude” value is typically measured by a barometric altimeter and is the determining factor for minima for Category I approaches, (e.g., ILS, GLS, or RNAV using VNAV). The “Height” value specified in parenthesis, typically a RA height above the touchdown zone (HAT), is advisory. The RA may not reflect actual height above terrain.

For most Category II and Category III fail passive approaches, the Decision Height is the controlling minima and the altitude value specified is advisory. A Decision Height is usually based on a specified radio altitude above the terrain on the final approach or touchdown zone.

Alert Height - AH

Alert heights are normally used for fail operational Category III operations. Alert height is a height above the runway, above which a Category III approach must be discontinued and a missed approach initiated if a specified failure occurs. Radio altimeters are set in accordance with the airline's policy or at alert height to assist in monitoring autoland status. Most regulatory agencies do not require visual references below alert height.

Procedure Turn and Initial Approach

Cross the procedure turn fix at flaps 5 maneuver airspeed. If a complete arrival procedure to the localizer and glide slope capture point has been selected via the CDU, the initial approach phase may be completed using LNAV and VNAV.

Approach

Both pilots should not be “heads-down” during the approach. In some cases, such as high density traffic, or when an arrival procedure is used only for reference, revising the FMC flight plan may not be appropriate.

For airplanes equipped with HUD, normally all maneuvering before the final approach is flown in the primary mode. On ILS approaches, pilots are encouraged to use the AIII mode and procedures whenever possible to maintain proficiency and to reinforce crew coordination.

During strong crosswinds, the HUD flight path vector symbol may display a dashed outline. Selecting a mode other than the Primary mode removes the speed and altitude tapes and increases the viewing area of the flight path vector. This may change the flight path vector symbol back to solid, displaying the current flight path of the airplane.

737 NG Flight Crew Training Manual

If displaying the arrival procedure is not desired, perform a “DIRECT TO” or “INTERCEPT COURSE TO” the FAF, OM, or appropriate fix, to simplify the navigation display. This provides:

- a display of distance remaining to the FAF, OM, or appropriate fix
- a depiction of cross track error from the final approach course
- LNAV capability during the missed approach procedure.

The approach procedure may be flown using HDG SEL or LNAV for lateral tracking and VNAV, LVL CHG, or V/S for altitude changes. VNAV is the preferred descent mode when the FMS flight plan is programmed for the intended arrival. When VNAV is not available, use LVL CHG for altitude changes greater than 1,000 feet. For smaller altitude changes, V/S permits a more appropriate descent rate.

When maneuvering to intercept the localizer, decelerate and extend flaps to 5. Attempt to be at flaps 5 and flaps 5 maneuver speed before localizer capture.

When operating in speed intervention (as installed) or an autothrottle SPD mode, timely speed selections minimize thrust lever movement during the approach. This reduces cabin noise levels and increases fuel efficiency. When flaps are extended, select the next lower speed just as the additional configuration drag takes effect.

Delaying the speed selection causes an increase in thrust, while selecting the lower speed too quickly causes thrust to decrease, then increase.

During the approach, adjust the map display and range to provide a scaled plan view of the area. When on an intercept heading and cleared for the approach, select the APP mode and observe the VOR/LOC and G/S flight mode annunciations are armed.

APP mode should not be selected until:

- the ILS or GLS is tuned and identified
- the airplane is on an inbound intercept heading
- both localizer and glide slope pointers appear on the attitude display in the proper position
- clearance for the approach has been received.

The glide slope may be captured before the localizer in some airplanes. The glide slope may be captured from either above or below. To avoid unwanted glide slope capture, LOC mode may be selected initially, followed by the APP mode.

When using LNAV to intercept the final approach course, ensure raw data indicates localizer interception to avoid descending on the glide slope with LOC not captured. If needed, use HDG SEL to establish an intercept heading to the final approach course.

Final Approach

The pilots should monitor the quality of the approach, flare, and landing (and rollout for airplanes with automatic rollout capability) including speedbrake deployment and autobrake application.

Note: The APP mode should be selected, both autopilots engaged in CMD, and the airplane stabilized on the localizer and glide path before descending below 800 feet RA.

At localizer capture, select the heading to match the inbound course. For normal localizer intercept angles, very little overshoot occurs. Bank angles up to 30° may be commanded during the capture maneuver. For large intercept angles some overshoot can be expected.

Use the map display to maintain awareness of distance to go to the final approach fix. When the glide slope pointer begins to move (glide slope alive), extend the landing gear, select flaps 15, and decrease the speed to flaps 15 speed.

At glide slope capture, observe the flight mode annunciations for correct modes. At this time, select landing flaps and VREF + 5 knots or VREF plus wind additive if landing manually, and do the Landing checklist. When using the autothrottle to touchdown, no additional wind additive is required to the final approach speed. The pilot monitoring should continue recommended callouts during final approach and the pilot flying should acknowledge callouts.

When established on the glide slope, set the missed approach altitude in the altitude window of the MCP. Extension of landing flaps at speeds in excess of flaps 15 speed may cause flap load relief activation and large thrust changes.

Check for correct crossing altitude and begin timing, if required, when crossing the final approach fix (FAF or OM).

There have been incidents where airplanes have captured false glide slope signals and maintained continuous on glide slope indications as a result of an ILS ground transmitter erroneously left in the test mode. False glide slope signals can be detected by crosschecking the final approach fix crossing altitude and VNAV path information before glide slope capture. A normal pitch attitude and descent rate should also be indicated on final approach after glide slope capture. Further, if a glide slope anomaly is suspected, an abnormal altitude range-distance relationship may exist. This can be identified by crosschecking distance to the runway with altitude or crosschecking the airplane position with waypoints indicated on the navigation display. The altitude should be approximately 300 feet HAT per NM of distance to the runway for a 3° glide slope.

If a false glide slope capture is suspected, perform a missed approach if visual conditions cannot be maintained.

737 NG Flight Crew Training Manual

See Note in this section regarding false glide slope capture while Intercepting Glide Slope from Above.

Below 1,500 feet radio altitude, the flare mode is armed. The FLARE annunciation indicates the second autopilot is fully engaged. As the lowest weather minimums are directly related to the system status, both pilots must observe the FLARE annunciation.

For fail operational airplanes, verify ROLLOUT is armed and LAND 3 or LAND 2 is annunciated.

Check that the A/P disengage warning light on each instrument panel is extinguished at 500 feet.

For fail operational airplanes, if an autoland annunciation changes or system fault occurs above AH that requires higher weather minimums (reversion to LAND 2 or NO AUTOLAND), do not continue the approach below these higher minimums unless suitable visual reference with the runway environment is established.

Airplanes with autopilots having fail operational capability are designed to safely continue an approach below AH after a single failure of an autopilot element. The autopilot protects against any probable system failure and safely land the airplane. AFDS design provides for an AH of at least 200 feet HAT but may be modified to a lower value by operators. The pilot should not interfere below AH unless it is clearly evident pilot action is required.

During an autoland with crosswind conditions, fail passive airplanes will touchdown in a crab. After touchdown, the rudder must be applied to maintain runway centerline. The autopilot must be disengaged immediately after touchdown. The control wheel should be turned into the wind as the autopilot is disengaged. The A/T disconnects automatically two seconds after touchdown.

During an autoland with crosswind conditions, fail operational airplanes (LAND 3 or LAND 2 annunciated), the runway alignment maneuver uses sideslip to reduce the crab angle of the airplane at touchdown. Alignment begins at 450 feet radio altitude or lower, depending on the strength of the crosswind. The amount of sideslip induced is limited to 5°. When a strong crosswind is present, the airplane does not fully align with the runway, but lands with a slight crab angle. In all cases, the upwind wing is low at touchdown.

The autobrakes should remain engaged until a safe stop is assured and adequate visibility exists to control the airplane using visual references.

For fail operational airplanes, the autopilot and autobrakes should remain engaged until a safe stop is assured and adequate visibility exists to control the airplane using visual references.

Intercepting Glide Slope from Above

The following technique may be used for ILS, GLS, or approaches using IAN; however it is not recommended for approaches using VNAV.

Normally the ILS profile is depicted with the airplane intercepting the glide slope from below in a level flight attitude. However, there are occasions when flight crews are cleared for an ILS approach when they are above the G/S. In this case, there should be an attempt to capture the G/S prior to the FAF. The map display can be used to maintain awareness of distance to go to the final approach fix. The use of autopilot is also recommended.

Note: Before intercepting the G/S from above, the flight crew must ensure that the localizer is captured before descending below the cleared altitude or the FAF altitude.

Note: In some instances, when intercepting the G/S from well above a 3° G/S, a false G/S capture can result in an unexpected rapid pitch-up command which can lead to a rapid loss of airspeed.

The following technique will help the crew intercept the G/S safely and establish stabilized approach criteria by 1,000 feet AFE:

- select APP on the MCP and verify that the G/S is armed
- establish final landing configuration and set the MCP altitude no lower than 1,000 feet AFE
- select the V/S mode and set -1000 to -1500 fpm to achieve G/S capture and be stabilized for the approach by 1,000 feet AFE. Use of the VSD (as installed) or the green altitude range arc may assist in establishing the correct rate of descent.

Monitor the rate of descent and airspeed to avoid exceeding flap placard speeds and flap load relief activation. At G/S capture observe the flight mode annunciations for correct modes and monitor G/S deviation. After G/S capture, continue with normal procedures. Comply with the recommendations on the use of speedbrakes found in Chapter 4 of this manual.

Note: If the G/S is not captured or the approach not stabilized by 1,000 feet AFE, initiate a go-around. Because of G/S capture criteria, the G/S should be captured and stabilized approach criteria should be established by 1,000 feet AFE, even in VMC conditions. See the section titled Stabilized Approach Recommendations earlier in this chapter for more information on stabilized approach criteria.

Delayed Flap Approach (Noise Abatement)

If the approach is not being conducted in adverse conditions that would make it difficult to achieve a stabilized approach, the final flap selection may be delayed to conserve fuel or to accommodate speed requests by air traffic control.

737 NG Flight Crew Training Manual

Intercept the glide slope with gear down and flaps 15 at flaps 15 speed. The thrust required to descend on the glide slope may be near idle. Approaching 1,000 feet AFE, select landing flaps, allow the speed to bleed off to the final approach speed, then adjust thrust to maintain it. Do the Landing checklist.

Decision Altitude or Height - DA(H)

The pilot monitoring should expand the instrument scan to include outside visual cues when approaching DA(H). Do not continue the approach below DA(H) unless the airplane is in a position from which a normal approach to the runway of intended landing can be made and suitable visual reference can be maintained. Upon arrival at DA(H), or any time thereafter, if any of the above requirements are not met, immediately execute the missed approach procedure. When visual contact with the runway is established, maintain the glide slope to the flare. Do not descend below the visual glide path.

Raw Data - (No Flight Director)

Raw data approaches are normally used during training to improve the instrument scanflow. If a raw data approach is required during normal operations, refer to the DDG or airline equivalent for the possibility of increased landing minima.

ILS deviation is displayed on the attitude display. ILS deviation may also be displayed on the navigation display by selecting an ILS mode on the EFIS Control Panel. The localizer course deviation scale on the attitude indicator remains normal scale during the approach. Continue to crosscheck the map display against the attitude indicator raw data.

The magnetic course/bearing information from the VOR/ADF pointers on the navigation display may be used to supplement the attitude display localizer deviation indication during initial course interception. Begin the turn to the inbound localizer heading at the first movement of the localizer pointer.

After course intercept, the track line and read-out on the navigation display may be used to assist in applying proper drift correction and maintaining desired course. Bank as needed to keep the localizer pointer centered and the track line over the course line. This method automatically corrects for wind drift with very little reference to actual heading required.

Large bank angles are rarely required while tracking inbound on the localizer. Use 5° to 10° of bank angle.

When the glide slope pointer begins to move (glide slope alive), lower the landing gear, extend flaps 15, and decelerate to flaps 15 speed. Intercepting the glide slope, extend landing flaps and establish the final approach speed. When established on the glide slope, preset the missed approach altitude in the altitude window. On final approach, maintain VREF + 5 knots or an appropriate correction for headwind component. Check altitude crossing the FAF. Begin timing, if required. To stabilize on the final approach speed as early as possible, it is necessary to exercise precise speed control during the glide slope intercept phase of the approach. The rate of descent varies with the glide slope angle and ground speed. Expedient and smooth corrections should be made based on the localizer course and glide slope indications. Apply corrections at approximately the same rate and amount as the flight path deviations.

The normal missed approach procedure applies when flying an approach with no flight director displayed. Flight director guidance appears if TO/GA is selected. Refer to Go-Around and Missed Approach - All Approaches, this chapter.

AFDS Autoland Capabilities

Refer to the applicable AFM for AFDS limitations and a description of demonstrated autoland capabilities.

The AFDS provides an indication of automatic landing availability via the Autopilot Status Annunciator (ASA) portion of the PFD. A degradation in autoland status is indicated by NO LAND 3 or NO AUTOLAND indication.

Both hydraulic systems A and B must be operational when initiating a Category III autoland approach. However, for fail operational airplanes during fail operational approaches, if a hydraulic system becomes inoperative below alert height, the automatic approach may be continued through landing and rollout. The pilot should not intervene unless it is clearly evident that pilot action is required.

Note: For autoland use flaps 30 or 40. For airplanes equipped with a fail operational autopilot using either LAND 3 or LAND 2, engine inoperative autoland may be used with flaps 30 if airplane performance permits.

WARNING: Autoland should not be attempted unless the final approach course path is aligned with the runway centerline. If the localizer beam is offset from the centerline the AFDS may cause the airplane to depart the runway.

ILS Performance

Most ILS installations are subject to signal interference by either surface vehicles or aircraft. To prevent this interference, ILS critical areas are established near each localizer and glide slope antenna. In the United States, vehicle and aircraft operations in these critical areas are restricted any time the weather is reported less than 800 foot ceiling and/or visibility is less than 2 statute miles.

737 NG Flight Crew Training Manual

Flight inspections of ILS facilities do not necessarily include ILS beam performance inside the runway threshold or along the runway unless the ILS is used for Category II or III approaches. For this reason, the ILS beam quality may vary and autolands performed from a Category I approach at these facilities should be closely monitored.

Flight crews must remember that the ILS critical areas are usually not protected when the weather is above 800 foot ceiling and/or 2 statute miles visibility. As a result, ILS beam bends may occur because of vehicle or aircraft interference. Sudden and unexpected flight control movements may occur at a very low altitude or during the landing and rollout when the autopilot attempts to follow the beam bends. At ILS facilities where critical areas are not protected, be alert for this possibility and guard the flight controls (control wheel, rudder pedals and thrust levers) throughout automatic approaches and landings. Be prepared to disengage the autopilot and manually land or go-around.

When flying a HUD AIII approach at ILS facilities where critical areas are not protected, be alert for the possibility of an approach warning. Be prepared to land if visual references are established or go-around.

For fail operational airplanes, the AFDS includes a monitor to detect significant ILS signal interference. If localizer or glide slope signal interference is detected by the monitor, the autopilot disregards erroneous ILS signals and remains engaged in an attitude stabilizing mode based on inertial data. Most ILS signal interferences last only a short time, in which case there is no annunciation to the flight crew other than erratic movement of the ILS raw data during the time the interference is present. No immediate crew action is required unless erratic or inappropriate autopilot activity is observed.

Autolands on Contaminated Runways - Fail Operational Airplanes

AFDS ROLLOUT mode performance cannot be assured when used on contaminated runways. The ROLLOUT mode relies on a combination of aerodynamic rudder control, nose wheel steering and main gear tracking to maintain the runway centerline using localizer signals for guidance. On a contaminated runway, nose wheel steering and main gear tracking effectiveness, and therefore airplane directional control capability, is reduced. To determine the maximum crosswind, use the most restrictive of the autoland crosswind limitation, or during low visibility approaches, the maximum crosswind authorized by the controlling regulatory agency. Consideration should also be given to the Landing Crosswind Guidelines published in chapter 6 of this manual or operator guidelines.

If an autoland is accomplished on a contaminated runway, the pilot must be prepared to disengage the autopilot and take over manually should ROLLOUT directional control become inadequate.

Low Visibility Approaches

A working knowledge of approach lighting systems and regulations as they apply to the required visual references is essential to safe and successful approaches. Touchdown RVR is normally controlling for Category I, II, and III approaches. For Category I and II approaches, mid and rollout RVR are normally advisory. For Category III operations mid and rollout RVR may be controlling. In some countries, visibility is used instead of RVR. Approval from the regulatory agency is required to use visibility rather than RVR.

During Category I approaches, visual reference requirements typically specify that either the approach lights or other aids be clearly visible to continue below DA(H). During Category I and II approaches, descent below 100 feet above touchdown zone elevation may require (depending upon the criteria of the applicable regulatory authority) the red terminating bars or red side row bars (ALSIF or Calvert lighting systems, or ICAO equivalent, as installed) to be distinctly visible. If actual touchdown RVR is at or above the RVR required for the approach, the runway environment (threshold, threshold lights and markings, touchdown zone, touchdown lights and markings) should become clearly visible resulting in a successful approach. After acquiring the red terminating bars or red side row bars, if the runway environment does not become distinctly visible execute an immediate missed approach.

Category III operations using fail passive autoland systems typically apply a DH of 50 feet when approaching the threshold. In this instance, refer to your company specific list of visual references to continue the approach. If not, execute an immediate missed approach.

Category III operations using fail operational autoland systems normally do not require specific visual references below AH.

A review of the approach and runway lighting systems available during the approach briefing is recommended as the pilot has only a few seconds to identify the lights required to continue the approach. For all low visibility approaches, a review of the airport diagram, expected runway exit, runway remaining lighting and expected taxi route during the approach briefing is recommended.

Regulatory agencies may require an additional 15% be added to the dry landing distance. Agencies may also require wind speed limitations less than maximum autoland wind speeds found in the FCOM.

737 NG Flight Crew Training Manual

Transition to Manual Approach or Landing

A transition from an AFDS approach to a manual approach can be accomplished anytime during the ILS approach. However pilots should be aware that when performing a dual autopilot approach, the stabilizer is automatically trimmed an additional amount nose up below 400 feet RA. If the autopilot is subsequently disengaged, forward control column force may be required to hold the desired pitch attitude.

Note: If the autopilot is disengaged below 400 feet RA during a dual channel approach, be alert for a mistrim condition.

AFDS System Configuration[Appendix A.2.8](#)

For system and equipment requirements, refer to your approved company documents for a complete list that is specific for your operation.

More detailed information concerning Category II and Category III operational requirements can be found in FAA advisory circulars or similar documents from other regulatory agencies.

Category II Operations

Category II approaches may be conducted using single or dual autopilots, or flight director only. For fail passive airplanes, two engines must be operating. For single autopilot operation, the autopilot must be disengaged no lower than the minimum altitude listed in the Limitations Chapter of the FCOM. The autothrottle should be disconnected when the autopilot is disengaged.

The fail operational airplane has been demonstrated to meet Category II criteria including autoland with one engine operating, for flaps 30 landing only (if performance allows).

Category III Operations

Category III operations are based on an approach to touchdown using the automatic landing system. Normal operations should not require pilot intervention. However, pilot intervention should be anticipated in the event inadequate airplane performance is suspected, or when an automatic landing cannot be safely accomplished in the touchdown zone. Guard the controls on approach through landing and be prepared to take over manually, if required.

The fail operational airplane has been demonstrated to meet Category III criteria with two engines operating for flaps 30 or 40 landing, and for Category III operations including autoland with one engine operating for flaps 30 landing only (if performance allows).

Note: For fail operational airplanes, the controls should be guarded through the landing roll.

AFDS Faults

Appendix A.2.9

Faults can occur at any point during an AFDS approach. Many non-normal situations or scenarios are possible. The flight deck is designed so that a quick analysis and decision can be made for virtually all non-normal or fault situations using the Autopilot/Autothrottle indicators, flight mode annunciations, master caution system and, for fail operational airplanes, autoland status annunciations.

For fail operational airplanes, faults leading to non-normal operations can be divided into two categories:

- those occurring above AH
- those occurring at or below AH.

If the flight crew is aware of the airplane equipment requirements for the approach, the following can be used for any AFDS fault indication:

Above Alert Height

Immediately after recognizing the fault from the master caution system, instrument flags, or engine indications, check autoland status annunciation.

- if the autoland status annunciation has not changed, and the equipment is not required for the approach, (e.g., flight director), continue the approach
- if the autoland status annunciation has changed, or the equipment is required for the approach, adjust to the appropriate higher minimums or go-around. However, if suitable visual reference is established, consider landing.

At or Below Alert Height

A thorough fault analysis was included as a part of the fail operational certification. Below 200 feet AGL a safe landing and rollout can be made with any probable system failure conditions.

Flight crew alerts (lights or aural) may occur at any time during the approach. For fail operational airplanes, if a master caution or aural occurs below alert height, do not disengage the autopilot unless the autopilot system is not controlling the airplane adequately. Below alert height, the AFDS fail operational design protects against any probable system failure and will safely land the airplane. The pilot should not intervene below AH unless it is evident that pilot action is required. If a fault affects the autothrottle or autobrakes, assume manual control of thrust and braking. Accomplish related procedures for system faults after rollout is complete and manual control of the airplane is resumed.

If the autopilot is unintentionally disengaged below alert height, the landing may be completed if suitable visual reference is established. Be alert for a mistrim condition.

737 NG Flight Crew Training Manual

If a go-around is initiated with the autopilot disengaged, the flight directors remain in approach mode until the TO/GA mode is engaged. Follow the missed approach procedure.

Fail Passive vs. Fail Operational Autoflight System

The following table provides a comparison of how a fail passive and fail operational AFDS system differ during an ILS approach.

General Information

	FAIL PASSIVE	FAIL OPERATIONAL
Alert height	None	Alert height - 200 feet above runway
ISFD	Not required	Required for LAND 3 only
ILS beam anomaly or Ground station failure	A/P disengages	Before LAND 3 or LAND 2 annunciates: <ul style="list-style-type: none"> • A/P disengages After LAND 3 or LAND 2 annunciates: <ul style="list-style-type: none"> • A/P remains engaged
	Note:	Execute a Go-Around unless suitable visual reference to the runway environment has been established
	Note:	For associated LOC and/or GS displays, see the FCOM.
Allowable crosswind	20 Knots	25 Knots
Hydraulic system A or B failure	Both A/Ps disengage	Before AH: <ul style="list-style-type: none"> • failed side A/P disengages • NO AUTOLAND annunciated After AH: <ul style="list-style-type: none"> • failed side A/P disengages • autoland and rollout may continue.



Approach - All Engines

	FAIL PASSIVE	FAIL OPERATIONAL
Below 1500 feet	ILS deviation monitor system test	
		A/P rudder servo test performed
		ROLLOUT armed and rudder engages
		LAND 3 or LAND 2 annunciates
	FLARE armed annunciates	
	Second A/P couples with flight controls	
At 800 feet	Second A/P must be engaged	
At 500 feet	Verify AFDS status <ul style="list-style-type: none"> • FLARE armed • no steady A/P WARNING light. 	Verify autoland status: <ul style="list-style-type: none"> • FLARE armed • no steady A/P WARNING light • LAND 3 or LAND 2.
At 450 feet		AFDS automatically decreases crab angles and controls adverse moments caused by a possible engine failure.
At 400 feet	Stabilizer is automatically trimmed nose up. A/P's disengage if FLARE is not armed by approximately 350 feet.	
At 50 feet	FLARE engaged	
	F/D command bars retract	F/D command bars remain visible
At 27 feet	A/T begins retarding RETARD annunciates	
Rollout	After touchdown <ul style="list-style-type: none"> • A/T disconnects after 2 seconds • disengage A/P • use rudder to maintain directional control 	After touchdown: <ul style="list-style-type: none"> • A/T disconnects after 2 seconds • do not disengage A/P • ROLLOUT annunciates • A/P maintains directional control • disengage A/P before turning off runway.

737 NG Flight Crew Training Manual

Approach and Go-Around - One Engine Inoperative

	FAIL PASSIVE	FAIL OPERATIONAL
General	<p>Single A/P only available, autoland not authorized</p> <p>Use of the A/T not recommended.</p>	<p>Dual A/P required for autoland.</p> <p>Autoland (performance permitting) authorized for flaps 30 only.</p> <p>Use of the A/T recommended for autoland. Connect A/T after LAND 3 or LAND 2 annunciates.</p> <p>Note: If an engine fails below AH, the autoland and rollout may continue.</p>
Rudder control	<p>Pilot must use rudder to control yaw.</p>	<p>Before LAND 3 or LAND 2 annunciates, the pilot must use rudder to control yaw.</p> <p>After LAND 3 or LAND 2 annunciates, rudder is controlled by A/Ps (rudder trim is ineffective).</p>
Go-Around	<p>Flaps 1</p>	<p>Flaps 15</p>
	<p>After TO/GA is engaged the AFDS initially commands a go-around attitude then transitions to maintain command airspeed.</p>	
	<p>Pilot must use rudder to control yaw.</p>	<p>If the go-around is initiated after LAND 3 or LAND 2 annunciates, yaw is initially controlled by the A/Ps.</p> <p>When the A/P reverts to single A/P operation, the pilot:</p> <ul style="list-style-type: none"> • must use rudder to control yaw • should disconnect the A/T.

ILS Approach - Landing Geometry

The following diagrams use these conditions:

- data is based on typical landing weight

737-800

- data for airplanes with a 1-position tail skid is shown before the “?”. Differences between the basic -800 and -800 airplanes with the short field performance option and a 1-position tail skid are negligible. Data for airplanes equipped with a 2-position tail skid is shown following the “?”.
- airplane body attitudes are based on flaps 30, VREF 30 + 5 knots and should be reduced by 1° for each 5 knots above this speed
- pilot eye height is measured when the main gear is over the threshold
- airplane ILS antenna crosses threshold at 50 feet.

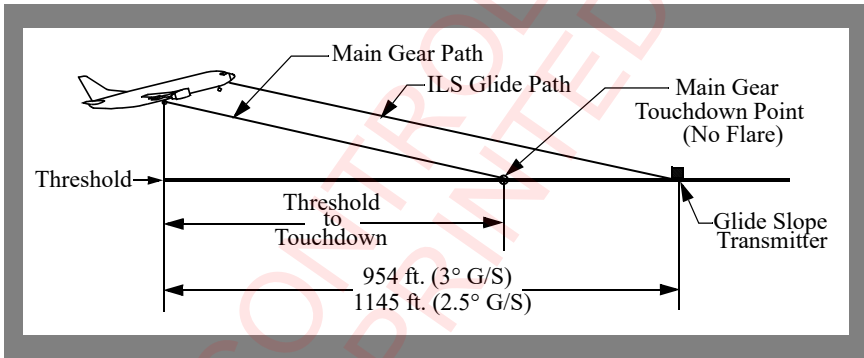

737 Model	Flaps 30		Main Gear over Threshold		Threshold to Main Gear Touchdown Point - No Flare (feet)
	Glide Path (degrees)	Airplane Body Attitude (degrees)	Pilot Eye Height (feet)	Main Gear Height (feet)	
- 600	2.5	4.1	49	33	763
	3.0	3.7	49	33	636
- 700	2.5	4.2	49	33	749
	3.0	3.7	48	33	624
- 800	2.5	2.9 / 4.1	49	33 / 32	753 / 725
	3.0	2.4 / 3.6	48	33 / 32	627 / 604

737 NG Flight Crew Training Manual

737 Model	Flaps 30		Main Gear over Threshold		Threshold to Main Gear Touchdown Point - No Flare (feet)
	Glide Path (degrees)	Airplane Body Attitude (degrees)	Pilot Eye Height (feet)	Main Gear Height (feet)	
- 900	2.5	2.1	48	33	763
	3.0	1.6	48	33	635
- 900ER	2.5	3.1	48	32	737
	3.0	2.6	48	32	614

Non-Normal Operations

This section describes pilot techniques associated with engine inoperative approaches. Techniques discussed minimize workload, improve crew coordination, and enhance flight safety. However, a thorough review of applicable Non-Normal Checklists associated with engine inoperative flight is a prerequisite to understanding this section.

One Engine Inoperative - Fail Passive Airplanes

AFDS management and associated procedures are similar to those used during the normal ILS approach. Flight director (manual) or single autopilot may be used. Weather minima for an ILS approach with one engine inoperative are specified in the applicable AFM and/or the operator's Operations Specification or equivalent.

Note: The airplane has been demonstrated to meet the criteria for flight director or single autopilot operation to Category I minimums with an engine initially inoperative if the airplane is trimmed for the condition. The use of dual autopilots with an engine inoperative is not authorized except for airplanes with a fail operational autopilot.

During a single autopilot or flight director (manual) approach, the pilot must use rudder pedal pressure to control yaw, followed by rudder trim to maintain an in-trim condition during the entire approach. A centered control wheel indicates proper trim.

Note: Use of the autothrottle for an approach with an engine inoperative is not recommended.

Minimize thrust lever movements to reduce both asymmetry and speed changes. Airplane configuration changes require little thrust change until capturing the glide slope.

Intercept the localizer with flaps 5 at flaps 5 speed. When the glide slope is alive, lower the landing gear, extend flaps to 15, set final approach speed, and decelerate.

Be prepared to take over manually in the event system performance is not satisfactory.

One Engine Inoperative - Fail Operational Airplanes

With an engine inoperative, autoland operations are authorized for flaps 30 only. AFDS management and associated procedures are similar to those used during the normal ILS approach. Refer to the PI chapter of the FCOM for flaps 30 gear down, engine inoperative performance. If flaps 30 performance is not satisfactory, a flaps 15 engine inoperative landing is required. Autoland operations are not authorized with flaps 15. Weather minima for an ILS approach with one engine inoperative are specified in the applicable AFM and/or the operator's Operations Specification or equivalent.

Note: After LAND 3 or LAND 2 is annunciated, use of the autothrottle for an approach with an engine inoperative is recommended for authorized operators.

Intercept the localizer with flaps 5 at flaps 5 speed. When the glide slope is alive, lower the landing gear, extend flaps to 15. At glide slope capture, select flaps 30, set VREF 30 + 5 knots.

For a discussion about how yaw is controlled during an approach with one engine inoperative, refer to the section titled Engine Inoperative, Rudder Trim - All Instrument Approaches later in this chapter.

Be prepared to take over manually in the event system performance is not satisfactory.

Additional engine-out logic is incorporated during runway alignment to ensure the downwind wing is not low at touchdown. If the crosswind is from the same side as the failed engine, then the airplane is crabbed by inducing a sideslip. This assures a "wings-level" approach. For moderate or strong crosswinds from the opposite side of the failed engine, no sideslip is induced as the failed engine high approach configuration guarantees an upwind wing low touchdown characteristic.

Engine Inoperative, Rudder Trim - All Instrument Approaches

On fail passive airplanes, the pilot must use rudder pedal pressure to control yaw, followed by rudder trim to maintain an in-trim condition during all approaches. Manually centering the rudder trim prior to thrust reduction for landing is normally unnecessary.

737 NG Flight Crew Training Manual

On fail operational airplanes, during a dual autopilot approach, the pilot must use rudder pedal pressure to control yaw, followed by rudder trim to maintain an in-trim condition until LAND 3 or LAND 2 annunciates. When LAND 3 or LAND 2 annunciates, rudder inputs are controlled by the autopilot. Directional control (yaw) is not affected by rudder trim with the autopilot in the VOR/LOC or ROLLOUT modes. However, the rudder trim is still operational and manual rudder trim inputs are counteracted by the autopilot. If rudder trim is used by the flight crew, an out-of-trim condition could develop which may lead to airplane control problems if the autopilot is disengaged. For this reason, the use of manual rudder trim is not recommended whenever LAND 3 or LAND 2 is announced.

Rudder trim may be set to zero to facilitate directional control during thrust reduction. This should be accomplished by 500 feet AFE to allow the PM ample time to perform other duties and make appropriate altitude callouts.

Centering the rudder trim before landing allows most of the rudder pedal pressure to be removed when the thrust of the operating engine is retarded to idle at touchdown. Full rudder authority and rudder pedal steering capability are not affected by rudder trim.

It may not be advisable to center the rudder trim due to crew workload and the possibility of a missed approach. However, if touchdown occurs with the rudder still trimmed for the approach, be prepared for the higher rudder pedal forces required to track the centerline on rollout.

Engine Failure On Final Approach

737-600, 737-700

If an engine failure should occur on final approach with the flaps in the landing position, the decision to continue the approach or execute a go-around should be made immediately. If the approach is continued and sufficient thrust is available, continue the approach with landing flaps. If the approach is continued and sufficient thrust is not available for landing flaps, retract the flaps to 15 and adjust thrust on the operating engine. Command speed should be increased to 15 knots over the previously set flaps 30 or 40 VREF. This sets a command speed that is equal to at least VREF for flaps 15 and is represented by the white colored bug on the airspeed tape. Wind additives should be added as needed, if time and conditions permit.

737-800 - 737-900ER

If an engine failure should occur on final approach with the flaps in the landing position, the decision to continue the approach or execute a go-around should be made immediately. If the approach is continued and sufficient thrust is available, continue the approach with landing flaps. If the approach is continued and sufficient thrust is not available for landing flaps, retract the flaps to 15 and adjust thrust on the operating engine. Command speed should be increased to 20 knots over the previously set flaps 30 or 40 VREF. This sets a command speed that is equal to at least VREF for flaps 15 and is represented by the white colored bug on the airspeed tape. Wind additives should be added as needed, if time and conditions permit.

Note: For fail operational airplanes, if an engine fails below AH, the autoland and rollout may continue.

If a go-around is required, follow the Go-Around and Missed Approach procedures except use flaps 15 initially if trailing edge flaps are at 30 or 40. Subsequent flap retraction should be made at a safe altitude and in level flight or a shallow climb.

GLS Approach (As installed)

The aviation industry has developed a positioning and landing system based on the Ground Based Augmentation System (GBAS). The GBAS Landing System (GLS) integrates satellite and ground-based navigation information to provide extremely accurate and stable position information for approach and landing guidance.

General

GLS consists of three major elements:

- a global satellite constellation (e.g., the U.S. GPS) that supports worldwide navigation position fixing
- a GLS facility that provides approach path definition with local navigation satellite correction signals near airports qualified for GLS approaches
- avionics in each airplane that process and provide guidance and control based on the satellite and local area augmentation signals.

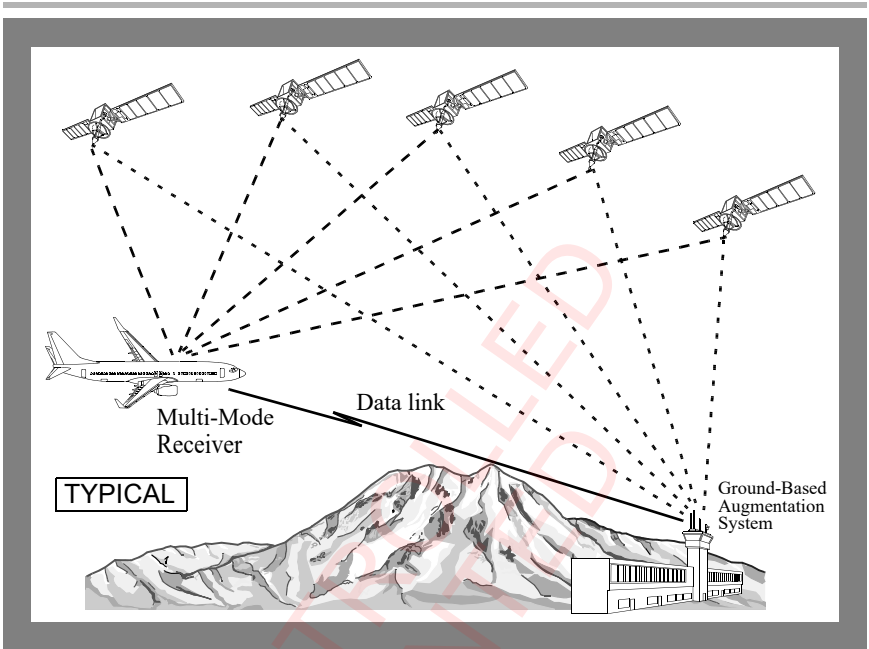

GLS approach procedures and techniques are identical to those of an ILS approach. GLS approaches are extraordinarily steady and smooth when compared with the current ILS system, even when critical areas necessary for the ILS approaches are unprotected during GLS approaches. There is no beam bending, no FM frequency interference, no interference from preceding aircraft, and no ground areas near the runway that need to be protected from surface traffic.

GLS approaches are certified to Category I approach minimums and have been demonstrated through autoland and rollout.

Approach

MCP mode selection requires the same pilot actions for ILS and GLS approaches. The approach selection for GLS is accomplished by selecting the GLS approach in the FMC and tuning a GLS channel versus selecting the ILS approach and tuning an ILS frequency.

GLS annunciations are identical to those used for ILS except that GLS is shown as the navigation reference on the PFD.

Crew actions while flying a GLS approach are just like those when flying an ILS approach. Note that both the Normal and Non-Normal Operations for GLS approaches are aligned with the Normal and Non-Normal Operations for an ILS approach.

Non - ILS Instrument Approaches

Non-ILS approaches are defined as:

- RNAV approach - an instrument approach procedure that relies on airplane area navigation equipment for navigational guidance. The FMS on Boeing airplanes is FAA-certified RNAV equipment that provides lateral and vertical guidance referenced from an FMS position. The FMS uses multiple sensors (as installed and selected) for position updating to include GPS, DME-DME, VOR-DME, LOC-GPS, and IRS.
- RNAV visual approach - a visual approach that relies on airplane navigation equipment to align the aircraft with a visual final. The approach is selected in the FMC and flown in the same way as an RNAV approach until reaching the visual segment.
- GPS approach - an approach designed for use by airplanes using stand-alone GPS receivers as the primary means of navigation guidance. However, Boeing airplanes using FMS as the primary means of navigational guidance, have been approved by the FAA to fly GPS approaches provided an RNP of 0.3 or smaller is used.

Note: A manual FMC entry of 0.3 RNP is required if not automatically provided.

- VOR approach
- NDB approach
- LOC, LOC-BC, LDA, SDF, IGS, TACAN, or similar approaches.

Non-ILS approaches are normally flown using VNAV or V/S pitch modes or IAN. Recommended roll modes are provided in the applicable FCOM procedure.

Non - ILS Instrument Approaches - General

Over the past several decades there have been a number of Controlled Flight Into Terrain (CFIT) and unstabilized approach incidents and accidents associated with non-ILS approaches and landings. Many of these could have been prevented by the use of Continuous Descent Final Approach (CDFA) methods. Traditional methods of flying non-ILS approaches involve setting a vertical speed on final approach, leveling off at step-down altitudes (if applicable) and at MDA(H), followed by a transition to a visual final approach segment and landing. These traditional methods involve changing the flight path at low altitudes and are not similar to methods for flying ILS approaches. Further, these traditional methods often require of the crew a higher level of skill, judgment and training than the typical ILS approach.

737 NG Flight Crew Training Manual

The following sections describe methods for flying non-ILS CDFA. These methods provide a constant angle approach, which reduces exposure to crew error and CFIT accidents. These methods also make it much easier for the crew to achieve a stabilized approach to a landing once suitable visual reference to the runway environment has been established.

A typical Instrument Approach using VNAV, IAN or V/S, as illustrated, assumes all preparations for the approach; such as review of the approach procedure, setting of minima, inbound course and radio tuning have been completed. The procedures illustrated focus generally on crew actions and avionics systems information. The flight pattern may be modified to suit local traffic and air traffic requirements.

The following discussions assume a straight-in instrument approach is being flown. A circling approach may be flown following an instrument approach using VNAV or V/S provided the MCP altitude is set in accordance with the circling approach procedure.

Types of Approaches

For airplanes not equipped with IAN, VNAV is the preferred method for accomplishing non-ILS approaches that have an appropriate vertical path defined on the FMC LEGS page. The section on Use of VNAV provides several methods for obtaining an appropriate path, to include published glide paths, and where necessary, a pilot constructed path. V/S may be used as an alternate method for accomplishing non-ILS approaches.

Airplanes with IAN are capable of using the MCP APP switch to fly non-ILS approaches that have an appropriate lateral and vertical path defined on the FMC LEGS page. Approaches using IAN provide the functions, indications, and alerting features similar to an ILS approach while following FMC glide path. Although non-ILS approaches using LNAV and VNAV can still be executed, IAN is normally used in place of LNAV and VNAV because of improved approach displays, alerts and standardized procedures.

Use of the Autopilot During Approaches

Automatic flight is the preferred method of flying non-ILS approaches. Automatic flight minimizes flight crew workload and facilitates monitoring the procedure and flight path. During non-ILS approaches, autopilot use allows better course and vertical path tracking accuracy, reduces the probability of inadvertent deviations below path, provides autopilot alerts and mode fail indications and enables lower RNP limits. Autopilot use is recommended until suitable visual reference is established on final approach.

Manually flying non-ILS approaches in IMC conditions increases workload and does not take advantage of the significant increases in efficiency and protection provided by the automatic systems. However, to maintain flight crew proficiency, pilots may elect to use the flight director without the autopilot when in VMC conditions.

Note: Currently, the VNAV PTH mode contains no path deviation alerting. For this reason, the autopilot should remain engaged until suitable visual reference has been established.

Raw Data Monitoring Requirements

During localizer-based approaches; LOC, LOC-BC, LDA, SDF, and IGS, applicable localizer raw data must be monitored throughout the approach.

During non-localizer based approaches where the FMC is used for course or path tracking (VOR, TACAN, NDB, RNAV, GPS, etc.), monitoring raw data is recommended, if available. When using the FMCS (LNAV) without GPS updating to conduct a terminal area procedure or an instrument approach, raw data must be monitored and checked to ensure correct navigation. For an instrument approach, this check should be done no later than the FAF.

During VOR, DME or ADF approaches when only single FMC, single IRS or single GPS sources are available, radio data should be selected on both NDs and raw data must be monitored and checked for correct navigation. For an instrument approach, this check should be done no later than the FAF.

Checking raw data for correct navigation may be accomplished by either of the following:

- selecting POS and comparing the displayed raw data with the navaid symbols on the map.

Note: The VOR radials and raw DME data should overlay the VOR/DME stations shown on the map and the GPS position symbol should nearly coincide with the tip of the airplane symbol (FMC position). Due to magnetic variation differences between the FMC database and the VOR station the VOR radial may not perfectly align with the FMC calculated course.

- displaying the VOR and/or ADF pointers on the map display and using them to verify your position relative to the map.

737 NG Flight Crew Training Manual

Typical Navigation Display

The following diagram represents a typical navigation display with the POS display selected.

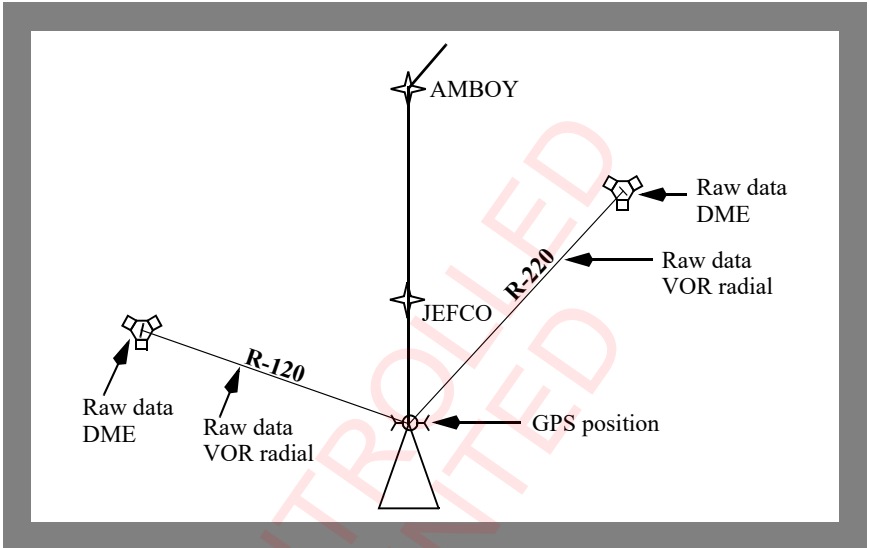
MAP Displays and Raw Data

The map mode should be used to the maximum extent practicable. The map display provides a plan view of the approach, including final approach and missed approach routing. The map increases crew awareness of progress and position during the approach.

The map is particularly useful when the inbound course does not align with runway centerline and allows the pilot to clearly determine the type of alignment maneuver required. The map can be used to integrate weather radar returns, terrain or traffic information within the approach path and airport area.

Note: When appropriate, compare airplane position on the map with ILS, VOR, DME, and ADF systems to detect possible map shift errors. Use of the POS function selectable on the EFIS control panel is the recommended method for making this comparison. The VOR and ADF pointers should be displayed on the map.

RNAV Approaches

RNAV approaches may be flown provided the RNP being used is equal to or less than the RNP specified for the approach and is consistent with the AFM demonstrated RNP capability.

Approach Requirements Relating to RNP

With appropriate operational approval, approaches requiring RNP alerting may be conducted in accordance with the following provisions:

- AFM indicates that the airplane has been demonstrated for selected RNP
- at least one GPS or one DME is operational
- any additional GPS or DME requirements specified by Operations Specification or by the selected terminal area procedure must be satisfied
- no UNABLE REQD NAV PERF - RNP alert is displayed during the approach.
- when operating with the following RNP values, or smaller:

Approach Type	RNP
NDB, NDB/DME	0.6 NM
VOR, VOR/DME	0.5 NM
RNAV	0.5 NM
RNAV (GPS)/(GNSS)	0.3 NM

UNCONTROLLED IF PRINTED

737 NG Flight Crew Training Manual

Use of LNAV

To use LNAV for approaches and missed approaches, a proper series of legs/waypoints that describe the approach route (and missed approach) must appear on the LEGS page. There are two methods of loading these waypoints:

- Database Selection
 - This method is required for RNAV and GPS approaches. An approach procedure selected through the FMC arrivals page provides the simplest method of selecting proper waypoints. Procedures in the database comply with obstruction clearance criteria for non-ILS approaches.
 - No waypoints may be added or deleted between the FAF and the MAP. If the approach to be flown is not in the database, another approach having the same plan view may be selected. For example, an ILS procedure might be selected if the plan view (route) is identical to an NDB approach. In this case, waypoint altitudes must be checked and modified as required. When an approach is flown by this “overlay” method, raw data should be monitored throughout the approach to assure obstacle clearance.

Note: If an NDB approach for the desired runway is in the database, an overlay approach should not be used.

- If a waypoint is added to or deleted from a database procedure, FMC “on approach” logic (as described in the FCOM) is partially or completely disabled and the VNAV obstacle clearance integrity of the procedure may be adversely affected. If an additional waypoint reference is desired, use the FIX page and do not modify waypoints on the LEGS page.
- Manual Waypoint Entry
 - Due to potentially inadequate terrain clearance, manual waypoint entry should not be accomplished for RNAV or GPS approaches, nor should this method be used with VNAV after the FAF.
 - When no procedure is available from the FMC arrivals page, manual entry of a series of waypoints may be accomplished to define the approach routing. The waypoints may be conveniently defined by using names of waypoints or navaids in the database, bearing/distance from such fixes, intersections of radials or latitude/longitude information.
 - Procedure turns and DME arcs cannot usually be manually entered (unless they can be defined by a series of waypoints). Deviation from the defined route may require use of “DIRECT TO” or “INTERCEPT COURSE TO” when intercepting the inbound course. Constant monitoring of raw data during the approach is required.

Note: Procedure turns and DME arcs may require use of HDG SEL.

LNAV cannot be used to track fix or radial data displayed on the map that is not part of the active route. A navaid/waypoint and the appropriate radial may be inserted on the FIX page to create a “course” line on the map that helps to improve situational awareness. A similar display may be created by manually tuning an appropriate VOR and selecting the desired course. These methods provide reference information on the map display only. They are not reflected on the LEGS page and cannot be tracked with LNAV. These methods should only be used when there is no opportunity to use an approach selected from the navigation database and should therefore be considered only when normal means of displaying approaches are not available. Pilots should be aware that the displayed course is an FMC calculated course and is not raw data information.

Note: HDG SEL should be used to fly the approach ground track.

Note: VNAV PTH operation using speed intervention (as installed) is not available with manually entered waypoints.

If the approach is not available in the navigation database, select the landing runway from the FMC arrivals page. The runway and associated extended centerline then displays on the map to aid in maintaining position awareness.

Pilots should not become involved in excessive “heads down” FMC manipulation to build map displays while at low altitude. Raw data VOR, ILS, and ADF displays should be used to avoid distractions during higher workload phases of flight. Map building should be avoided below 10,000 feet AGL.

Use of VNAV

Approaches using VNAV may be accomplished using any of the recommended roll modes provided in the FCOM procedure.

737 NG Flight Crew Training Manual

A vertical path suitable for use of VNAV is one that approximates 3° and crosses the runway threshold at approximately 50 feet. To obtain such a VNAV path, maximum use of the navigation database is recommended. For approaches where an RNP is specified, or approaches where a DA(H) is used, the waypoints in the navigation database from the FAF onward may not be modified except to add a cold temperature correction, when appropriate, to the waypoint altitude constraints. There are two types of approaches in the navigation database for construction of a suitable final approach path:

- approaches with a glide path (GP) angle displayed on the final approach segment of the LEGS page. The final approach segment is completely compatible with VNAV and complies with final approach step-down altitudes (minimum altitude constraints).
- approaches where no GP angle is published and where the approach end of the runway is defined by a runway waypoint (RWxx) or a missed approach point fix (MXxx or a named waypoint) exists. Normally these waypoints display an approximate 50 foot threshold crossing altitude constraint and may be used “as is” for VNAV. If the RWxx waypoint altitude constraint does not coincide with approximately 50 feet, this waypoint may be modified with a threshold crossing altitude of approximately 50 feet.

Note: Threshold crossing altitude normally requires entry of a four-digit number. Example: enter 80 feet as 0080.

- VNAV may be used for approaches modified in this way; however, the approach should be flown by constant reference to raw data (VOR, NDB, DME, etc.) and compliance with each minimum altitude constraint is required. Use of a DA(H) is not recommended when the final approach is manually constructed in this manner.
- ILS approaches coded with the appropriate threshold crossing height may be used as an overlay for other approaches such as LOC or NDB.

When appropriate, make cold temperature altitude corrections by applying a correction from an approved table to the waypoint altitude constraints. The FMC obtains the GP angle displayed on the LEGS page from the navigation database. This GP angle is based on the standard atmosphere and is used by the FMC to calculate the VNAV path which is flown using a barometric reference. When OAT is lower than standard, true altitudes are lower than indicated altitudes. Therefore, if cold temperature altitude corrections are not made, the effective GP angle is lower than the value displayed on the LEGS page. When cold temperature altitude corrections are made, VNAV PTH operation and procedure tuning function normally; however, the airplane follows the higher of the glide path angle associated with the approach (if available) or the geometric path defined by the waypoint altitude constraints.

Note: Temperature corrections redefine the glide path only if the FMC has the geometric path option installed. Reference the applicable FCOM for optional equipment installation.

Note: For VNAV operations, cold temperature altitude corrections are only permitted for airplanes with FMC update U10.6 or later.

When on final approach, VNAV may be used with speed intervention active (as installed) to reduce workload. Adding speed constraints to the final approach waypoints is normally not needed and causes extra workload without providing any safety benefit. This also reduces the ability to make last minute approach changes. However, if needed speed constraints may be changed if the default value is not suitable.

To prevent unnecessary level offs while descending in VNAV before the final approach, reset the MCP altitude selector to the next lower constraint before altitude capture, when compliance with the altitude restriction is assured.

Use of Altitude Intervention (As installed) during Approaches using VNAV

Altitude intervention is appropriate during approaches only if the AFDS enters VNAV ALT mode above the approach path and descent must be continued. Entering VNAV ALT mode can occur if passing a waypoint on the approach and the crew has failed to reset the MCP altitude to a lower altitude. If this occurs, set the MCP altitude to the next lower altitude constraint or the TDZE, as appropriate, and select altitude intervention. When VNAV altitude intervention is selected, VNAV path deviation indications on the map display disappear momentarily while the path is recalculated, but should reappear.

When on-approach logic is active and the airplane is below the VNAV path, when altitude intervention is selected, level flight is commanded until reaching the VNAV path, then the airplane captures the VNAV path.

737 NG Flight Crew Training Manual

When using VNAV PTH or VNAV SPD, and selecting altitude intervention:

- prior to FMC U10.6, approach altitude constraints are deleted if the MCP altitude is beyond the next altitude constraint.
- with FMC U10.6 and later, approach waypoint altitude constraints are not deleted by the use of altitude intervention.

When using VNAV ALT, selection of altitude intervention:

- may delete down path altitude constraints if the altitude constraint is within 150 feet of the current airplane altitude
- does not affect other altitude constraints.

Non - ILS Approach - One Engine Inoperative

Maneuvering before and after the final approach fix with one engine inoperative is the same as for an all engine non-ILS approach.

Procedure Turn and Initial Approach

Cross the procedure turn fix at flaps 5 and flaps 5 maneuver airspeed. If a complete arrival procedure has been selected via the CDU, the initial approach phase may be completed using LNAV and VNAV path, or other appropriate modes.

Vertical Path Construction[Appendix A.2.9](#)

This section describes typical final approach vertical profile (path) construction criteria as they relate to flying instrument approaches using VNAV. This information may also be useful to pilots who wish to fly the vertical path using V/S.

Where there is a glide path (GP) angle coded in the navigation database, the FMC builds the descent path upward and back in the direction of the FAF by starting at the location of the missed approach waypoint (MAP) and its associated altitude constraint. The FMC calculates this path using the coded GP angle, also called the vertical angle. The MAP is normally shown on the LEGS page as a RWxx or MXxx waypoint. In some cases a named waypoint is used as the MAP. A GP angle is coded in the navigation database for nearly all straight-in approach procedures.

This GP angle is normally defined by the regulatory authority responsible for the approach procedure and provides a continuous descent at a constant flight path angle for a final approach path that complies with minimum altitudes at intermediate step-down fixes. The typical GP angle is approximately 3.00°, but can vary from 2.75° to 3.77°.

The projection of the vertical path upward and back toward the FAF along this coded GP angle stops at the next higher limiting altitude in the vertical profile. This limiting altitude is the more restrictive of the following:

- the “At” altitude on the constrained waypoint preceding the MAP
- the first approach waypoint for the selected approach procedure.
- the crossing altitude on the next “at or above” constrained waypoint preceding the FAF.

The following examples show typical VNAV final approach paths where there is a GP angle in the navigation database. The first example shows an RWxx missed approach waypoint. The second example below shows the VNAV final approach path where there is a missed approach waypoint before the runway. Note that in the second case the projected path crosses the runway threshold at approximately 50 feet. VNAV guidance is level flight, however, when the airplane passes the missed approach point. Both examples are for “At” altitude constraints at the FAF.

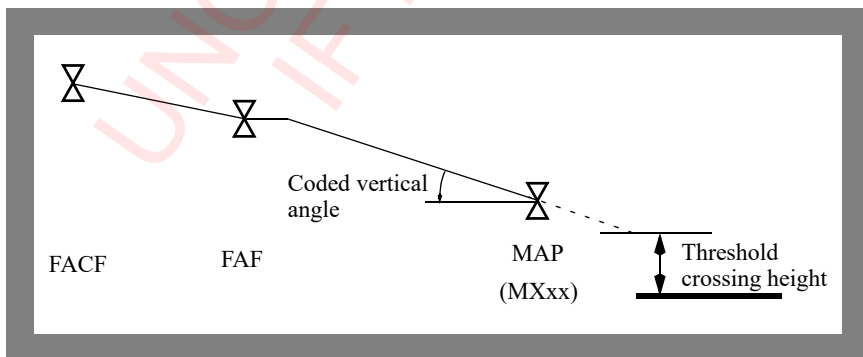
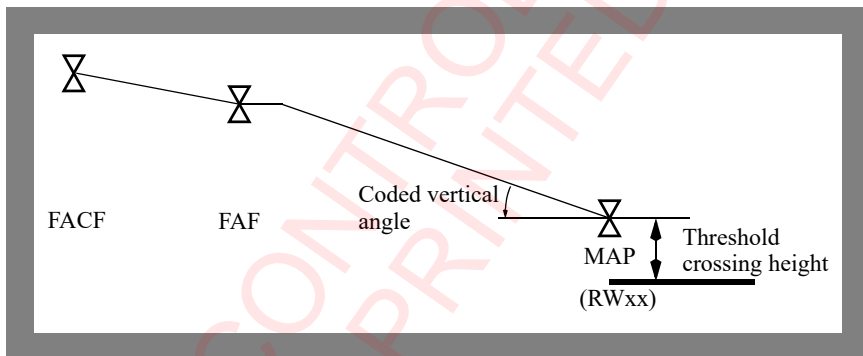

Note: The final approach course fix (FACF) is typically located on the final approach course approximately 7 NM before the FAF. The FAF referred to in the following procedures refers to the charted FAF and is intended to mean the point at which the final approach descent is begun.

737 NG Flight Crew Training Manual

For the non-ILS approach procedures with an “At” constraint altitude at the FAF, a short, level segment between the FAF and the final glide path (also called a “fly-off”) may result. For the ILS procedure, the constraint altitude at the FAF is computed to be the crossing altitude of the glide slope.

For procedures where both the FAF and FACF are coded with “at or above” altitude constraints, the crew should consider revising the FACF altitude constraint to “at” (hard constraint). This enables a shallower path before the FAF, permitting a normal deceleration for flap and gear extension. Example: In the diagram above, if both the FACF and the FAF contain “xxx/4000A” waypoint constraints, the crew should change “4000A” to “4000” at the FACF to modify the path for a more normal deceleration.

Crews can expect to see several other variations of approach path construction:

- approaches where the FAF has an “at or above” waypoint altitude constraint. The GP angle normally terminates at the FACF altitude constraint or the cruise altitude, whichever is lower. When this type of path is flown, the airplane passes above the FAF
- where there is more than one GP angle, such as for ILS approaches, the airplane uses the GP angle for the active leg to define the VNAV approach path. These types of paths are shown on the LEGS page as having two GP angle values, one approaching the FAF, the second approaching the runway (missed approach point).

Note: The coded GP angle is steeper than normal in temperatures warmer than ISA standard and is shallower than normal in temperatures colder than ISA standard.

Note: ILS approaches may have step-down fixes published between the FAF and the MAP (for G/S OUT use) which are not included in the FMC database procedure. The vertical angle in the FMC database procedure may not satisfy the step-down minimum altitudes inside the FAF on these approaches. Use of VNAV PTH or IAN for these procedures is not recommended without operator approval. However, published localizer (LOC) only approaches are compatible with VNAV PTH.

Instrument Approach Using VNAV

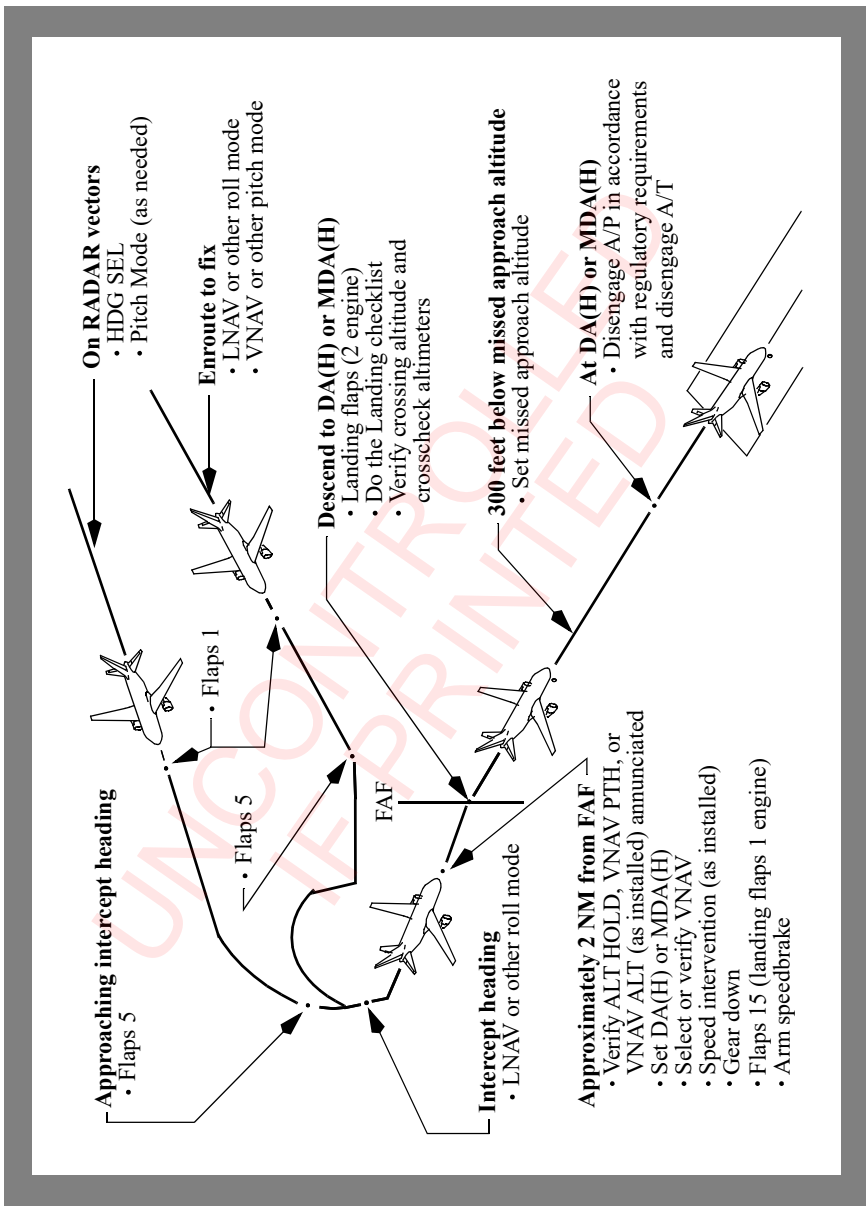

737 NG Flight Crew Training Manual

Approach Preparations for using VNAV

Select the approach procedure from the arrivals page of the FMC. Tune and identify appropriate navaids. Do not manually build the approach or add waypoints to the procedure. If additional waypoint references are desired, use the FIX page. To enable proper LNAV waypoint sequencing, select a straight-in intercept course to the FAF when being radar vectored to final approach. Verify/enter the appropriate RNP and set the DA(H) or MDA(H) using the baro minimums selector. If required to use MDA(H) for the approach minimum altitude, the barometric minimums selector may be set at MDA(H) + 50 feet to ensure that if a missed approach is initiated, descent below the MDA(H) does not occur during the missed approach.

Note: The approach RNP value is determined from one of three sources: manual entry by the flight crew, FMC default, or the navigation database. A manual entry overrides all others. If the navigation database contains an RNP value for the final approach leg, the RNP will appear when the leg becomes active, or up to 30 NM prior if the previous leg does not have an associated RNP value. The FMC default approach RNP will appear (no manual entry or navigation database value) when within 2 NM of the approach waypoint, including approach transitions, or when below 2,000 feet above the destination airport.

Enter the appropriate wind additive on the approach reference page or use speed intervention, if available.

Transition to an Instrument Approach using VNAV

There are several techniques which help ensure a smooth descent transition to a non-ILS final approach where VNAV PTH will be used.

Note: The FAF is normally the waypoint shown on the LEGS page and map display just before the final approach segment. The following discussions assume the FAF altitude constraint is set in the MCP while descending toward the FAF.

If descending to the FAF altitude in LVL CHG or V/S, at approximately 2 NM before the FAF verify that ALT HOLD is displayed before setting DA(H) or MDA(H) in the MCP. If the DA(H) or MDA(H) is set while LVL CHG or V/S is still displayed, the airplane may descend below the FAF altitude constraint before intercepting the glide path. After DA(H) or MDA(H) is set, select or verify VNAV. Speed intervention (as installed) may also be engaged, if desired.

If descending in VNAV PTH before final approach and the situation permits a continuous descent through final approach, remain in VNAV PTH while configuring the airplane for approach and landing. The airplane slows automatically to the maneuver speed for the current flap setting. Reset the MCP to DA(H) or MDA(H) approximately 2 NM before the FAF (waypoint just before the final approach segment) to prevent level off. Speed intervention (as installed) may also be engaged, if desired.

If descending in VNAV SPD, the AFDS changes to VNAV PTH automatically when approaching the FAF if the airplane is on or below the path. Reset the MCP to the DA(H) or MDA(H) approximately 2 NM before the FAF. If the AFDS enters ALT HOLD mode beyond the FAF, set DA(H) or MDA(H) in the MCP and select VNAV without delay. If VNAV ALT (as installed) has engaged beyond the FAF, set DA(H) or MDA(H) in the MCP and select altitude intervention without delay to enable continued descent on the final approach path. Execute a missed approach if the deviation above path becomes excessive enough to prevent achieving a stabilized approach.

Prior to final approach, the MCP altitude should be set at the appropriate altitude constraint (normally that for the next waypoint) to assure compliance with approach minimum altitudes while descending on the approach. To avoid leveling off, reset the MCP to the following waypoint altitude constraint as soon as the next waypoint altitude constraint is assured. However, if compliance with an altitude constraint is in question, consider leveling off or reducing the rate of descent to ensure a safe path.

Final Approach using VNAV

Approaching intercept heading, select flaps 5. When established on an intercept heading, select LNAV or other appropriate roll mode. Approaching the FAF (approximately 2 NM), set the DA(H) or MDA(H) in the MCP altitude window, select VNAV, and ensure VNAV PTH and appropriate roll mode is annunciated. Select gear down, flaps 15 and arm the speedbrake. Adjust speed if using speed intervention.

Note: If desired altitude is not at an even 100 foot increment, set the MCP altitude to the nearest 100 foot increment above the altitude constraint or MDA(H).

When using LNAV to intercept the final approach course, shallow intercept angles or intercept angles that result in an overshoot may result in delayed capture of the final approach course. The FAF should not be crossed and descent should not begin if the airplane is not on the final approach course.

Note: For approach procedures where the vertical angle (“GP” angle shown on the LEGS page) begins earlier in the approach (prior to the FAF), the MCP may be set to the DA(H) or MDA(H) once established on the vertical angle.

737 NG Flight Crew Training Manual

When initiating descent on the final approach path, select landing flaps, slow to final approach speed and do the Landing checklist. If the charted FAF is too close to the runway to permit a stabilized approach, consider establishing final approach pitch mode and configuring for approach and landing earlier than specified in the FCOM procedure.

With the MCP altitude set to DA(H) or MDA(H) and the airplane stabilized on the final approach path, the map altitude range arc assists in determining the visual descent point (VDP). As soon as the airplane is at least 300 feet below the missed approach altitude and stabilized on final approach in VNAV PTH, set the MCP altitude to the missed approach altitude. VNAV path deviation indications on the map display assist in monitoring the vertical profile. The autopilot tracks the path in VNAV PTH resulting in arrival at, or near, the visual descent point by the DA(H) or MDA(H).

Note: Before selection of flaps 15 or greater, while descending in VNAV PTH in strong gusty wind conditions, the AFDS may revert from VNAV PTH to LVL CHG due to minimum speed reversion protection. If the MCP altitude is set at or above the DA(H) or MDA(H), the airplane will level off when reaching DA(H) or MDA(H) if there is no pilot intervention, preventing descent into the terrain. This could result in excessive rates of descent toward the MCP altitude. If an AFDS reversion occurs beyond the FAF or on a leg that requires use of VNAV PTH, the crew should immediately initiate a missed approach.

On the VNAV approach, the missed approach altitude is set after established on the final descent and more than 300 feet below the missed approach altitude. Some approaches have missed approach altitudes that are lower than the altitude at which the FAF is crossed. The flight crew must wait until the airplane is at least 300 feet below the missed approach altitude before setting the missed approach altitude in the MCP to avoid level off from occurring during the final approach descent.

MCP Altitude Setting During Approach Using VNAV

For approaches using VNAV PTH, where there is a published GP angle, the MCP altitude may be set according to Landing Procedure - Instrument Approach using VNAV found in Normal Procedures. The MCP altitude is set to the DA(H)/MDA(H) just prior to the FAF altitude and reset on final approach to the missed approach altitude.

For instrument approaches where there are closely spaced waypoints between the IAF and the FAF, operators may permit crews, with appropriate training to set the FAF altitude initially, then when nearing the FAF altitude, the MCP altitude may be set according to the Normal Procedures.



For approaches where there is a published GP angle between the IAF and the FAF, the MCP altitude may be set to the DA(H) when intercepting the published GP.

Decision Altitude (DA(H)) or Minimum Descent Altitude (MDA(H))

When specifically authorized by the appropriate regulatory authority, non-ILS approaches may be flown to the following minima:

- a published VNAV DA(H)
- a published MDA(H) used as a decision altitude.

If not specifically authorized to use the MDA(H) as a DA(H), use the MDA(H) specified for the instrument procedure being flown.

The following diagram illustrates an approach procedure containing DA(H) minimums for approaches using Localizer Performance with Vertical guidance (LPV) and LNAV/VNAV. The diagram also shows MDA(H) minimums for an approach using LNAV only and a circling approach.

STRAIGHT-IN LANDING RWY 28R						CIRCLE-TO-LAND			
LPV DA(H) 263' (250')		LNAV/VNAV DA(H) 822' (809')		LNAV MDA(H) 1040' (1027')		Max Kts.	MDA(H)		
ALS out		ALS out		ALS out					
A	RVR 24 or 1/2	RVR 40 or 3/4	2	2 3/4	RVR 40 or 3/4	RVR 60 or 1 1/4	90	1040' (1027') - 1 1/4	
B					RVR 50 or 1	1 1/2	120	1040' (1027') - 1 1/2	
C					2 1/4	2 1/2	3	140	1040' (1027') - 3
D					2 1/2			165	1060' (1147') - 3

Note: Some non-ILS approaches specify a VNAV DA(H). Regulations may require use of the autopilot in the VNAV PTH mode to permit use of the DA(H).

Note: If using an MDA(H), the crew may wish to set the barometric minimums selector at MDA(H) + 50 feet. Initiating a missed approach approximately 50 feet above the MDA(H) may be necessary to avoid descending below the MDA(H) during the missed approach. This technique is an acceptable means of complying with the MDA(H) during constant angle non-ILS approaches where a level off at MDA(H) is not planned.

When reaching the DA(H) or MDA(H), be prepared to disengage the autopilot in accordance with regulatory requirements. Disconnect the autothrottle when disengaging the autopilot. Land or execute an immediate go-around.

737 NG Flight Crew Training Manual

The pilot monitoring should expand the instrument scan to include outside visual cues when approaching DA(H) or MDA(H). Do not continue the approach below DA(H) or MDA(H) unless the airplane is in a position from which a normal approach to the runway of intended landing can be made and suitable visual reference can be maintained. Upon arrival at DA(H) or MDA(H) or any time thereafter, if any of the above requirements are not met, immediately execute the missed approach procedure.

When suitable visual reference is established, maintain the descent path to the flare. Do not descend below the visual glide path. While VNAV PTH guidance may still be used as a reference once the airplane is below DA(H) or MDA(H), the primary means of approach guidance is visual.

Note: VNAV path guidance terminates once the missed approach fix is passed, and VNAV disengages.

Simulated Instrument Approach Using VNAV

To maintain proficiency, crews may practice instrument approach using VNAV procedures while flying ILS approaches as follows:

- ensure the ILS is tuned and identified and the ILS raw data is monitored throughout the approach
- track the localizer using VOR/LOC or LNAV as the roll mode
- use VNAV as the pitch mode to track the GP angle. The GP angle on the approach chart normally coincides with the ILS glide slope angle
- disengage the autopilot by the minimum altitude specified in the Limitations chapter of the FCOM.

Note: Limit the use of the above technique to VMC weather conditions.

In ambient temperature conditions warmer than ISA standard, the airplane may remain slightly high relative to the ILS glide slope, and in temperatures colder than ISA standard, the airplane may remain slightly lower than the ILS glide slope. Discontinue use of this technique and manually track the localizer and glide slope if localizer or glide slope deviations become unacceptable.

Instrument Approach Using IAN

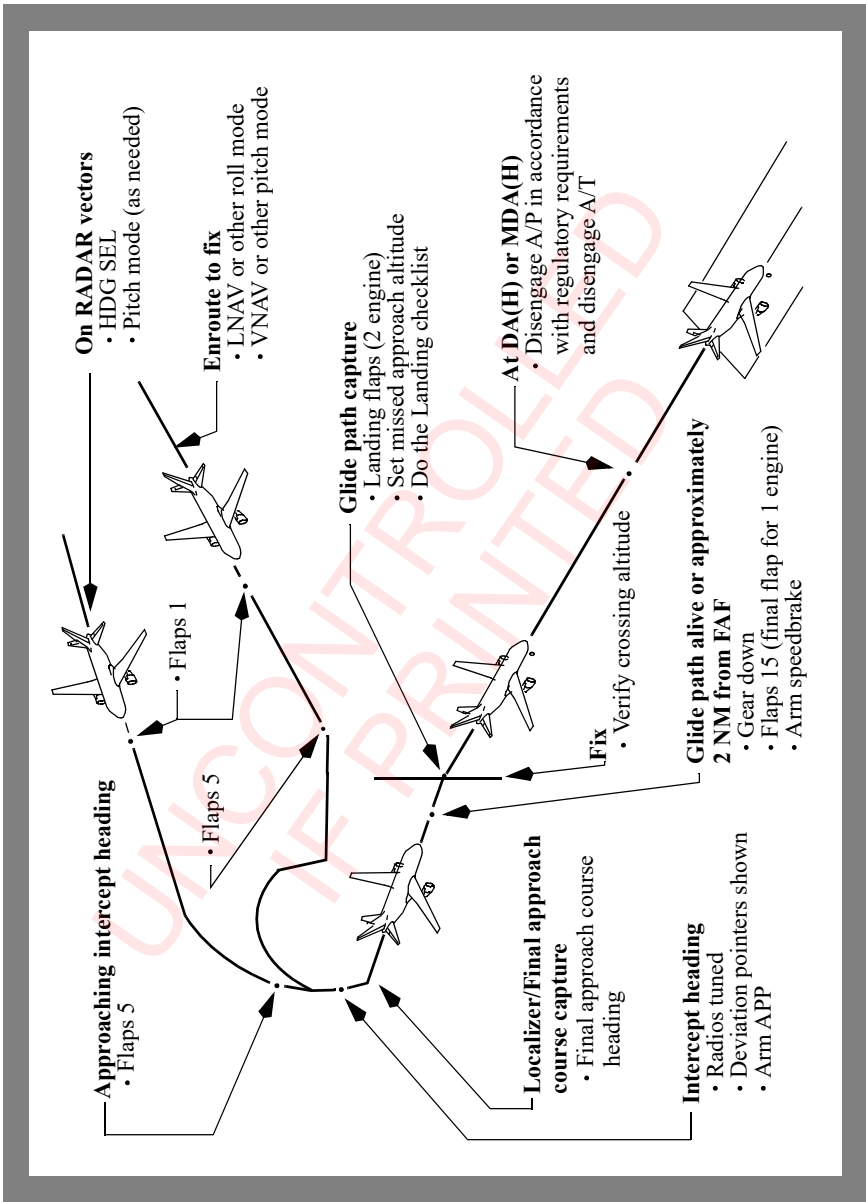

737 NG Flight Crew Training Manual

Use of IAN (As installed) - General

The approach profile illustrated depicts crew actions used during an approach using Integrated Approach Navigation (IAN). Since the techniques for approaches using IAN are similar to ILS approach techniques, only items considered unique to IAN are discussed in the remainder of this section. The approach profile illustrated assumes all preparations for the approach such as review of the approach procedure and setting of minima and radios, as required, are complete.

Airplanes with IAN are capable of using the MCP APP switch to execute instrument approaches based on flight path guidance from the FMC. Approaches using IAN provide the functions, indications and alerting features similar to an ILS approach. Although non-ILS approaches using LNAV and VNAV can still be performed, IAN is normally used in place of LNAV and VNAV because of standardized procedures.

Note: The glide path generated by the FMC is based on barometric data which is impacted by temperature deviation from ISA temperature. During approaches with temperatures above ISA, the generated IAN glide path can be slightly higher than the visual glide slope indicator path, for example from a PAPI or VASI. In these conditions, if the crew follows the visual glide slope the airplane will be below the IAN glide path which will cause a GLIDESLOPE alert to occur.

Approach types that can use IAN:

- RNAV
- GPS
- VOR approach
- NDB approach
- LOC, LOC-BC, LDA, SDF, TACAN, or similar approaches.

IAN Requirements and Restrictions

- airplanes must be equipped with FMC U10.5 or later and IAN FMA displays
- QFE operation is not authorized



- RNP appropriate for the approach must be used
- approaches using IAN are not authorized for RNAV (RNP) AR (airplanes with U12 and earlier).
- raw data monitoring is required during localizer based approaches
- waypoints in the navigation database from the FAF onward may not be modified except as described below
 - for airplanes with FMC update U10.7 or earlier, cold temperature altitude corrections are not permitted. This is because the AFM does not allow any altitude modification for the FAF or any waypoints between the FAF and the runway
 - for airplanes with FMC update U10.8A, cold temperature altitude corrections are permitted for the FAF, or any waypoints between the FAF and the runway. However, the corrections must be entered prior to reaching the IAF, and only if the waypoints have an “at or above” altitude restriction.
 - for airplanes with FMC update U11.0 and later, cold temperature altitude corrections are permitted for the FAF, or any waypoints between the FAF and the runway.

IAN Recommendations

- the use of IAN is recommended for straight-in approaches only
- during FMC based non-ILS approaches, raw data monitoring is recommended when available in accordance with the techniques described in the Non-ILS approach section in this chapter.

Flight Mode Annunciations and other IAN Features

FMA's vary depending on the source of the navigation guidance used for the approach, navigation radio or FMC.

For localizer based approaches:

Approach	FMA
ILS with G/S out, LOC, LDA, SDF	VOR/LOC and G/P
B/C LOC	B/CRS and G/P

If the FMC is used for lateral (course) guidance:

Approach	FMA
GPS, RNAV	FAC and G/P
VOR, NDB, TACAN	FAC and G/P

737 NG Flight Crew Training Manual

Approach Preparations for using IAN

IAN may be used with the flight director, single autopilot, or flown with raw data. The procedure turn, initial approach, and final approach are similar to the ILS.

For FMC based approaches, a proper series of legs/waypoints describing the approach route including an appropriate vertical path or glide path (GP) angle must appear on the LEGS page. A GP angle displayed on the LEGS page means the vertical path complies with final approach step-down altitudes (minimum altitude constraints). A typical GP angle suitable for an approach using IAN is one that approximates 3° and crosses the runway threshold at approximately 50 feet.

The appropriate procedure must be selected in the FMC. If final approach course guidance is derived from the localizer, the radios must be tuned to the appropriate frequency. If final approach course guidance is derived from the FMC, the ILS or GLS should not be tuned. When flying a localizer approach with the glide slope out or unreliable (LOC GS out), the G/S prompt is selected OFF to ensure that the FMC generated glide path is flown.

Note: For all approaches, including B/C LOC approaches, the inbound front course must be set in the MCP.

Final Approach using IAN

When on an intercept heading and cleared for the approach, select the APP mode. Set missed approach altitude after glide path capture.

APP mode should not be selected until:

- the guidance to be used for the final approach is tuned and identified (as needed)
- the airplane is on an inbound intercept heading
- both lateral and vertical deviation pointers appear on the attitude display in the proper position
- clearance for the approach has been received

Note: The IAN GP is a barometric vertical path and does not guarantee compliance with FMC altitude constraints prior to the FAF. However, the IAN GP will be at or above altitude constraints between the FAF and the missed approach waypoint that are included in the FMC database procedure.

Unlike an ILS approach, where configuration for landing is initiated when the glide slope comes alive, during an IAN approach, configuration for landing is initiated approximately 2 NM from the FAF. Waiting until the glide path is alive may give the crew too little time to accomplish all recommended actions before intercepting the glide path. This is because the IAN glide path full scale deflection is variable depending upon the vertical RNP value in use. At low vertical RNP values, the vertical deviation pointer does not move until just before intercepting the glide path. Initiating the landing configuration at approximately 2 NM from the FAF gives the crew time to slow and select landing flaps at the FAF.

Deviation scales are proportional to RNP. Similar to the ILS localizer and glide slope deviation scales, the IAN deviation scales become more sensitive as the airplane approaches the runway.

GPWS glide slope alerting is provided on IAN airplanes during ILS and approaches using IAN. GPWS glide slope alerts provide indications when the airplane deviates below the glide slope (ILS) or glide path (IAN) before reaching a full scale deflection. During the approach, any time a full scale vertical or lateral deflection occurs or an UNABLE REQ'D NAV PERF - RNP alert occurs and suitable visual reference has not been established, a missed approach must be executed.

If the final approach course is offset from the runway centerline, maneuvering to align with the runway centerline is required. When suitable visual reference is established, continue following the glide path (GP) angle while maneuvering to align with the runway.

With the autopilot engaged below 100 feet radio altitude, an aural GPWS alert sounds and the autopilot engage status flashes to remind the crew that the autopilot must be disengaged before landing.

Decision Altitude (DA(H)) or Minimum Descent Altitude (MDA(H))

When specifically authorized by the appropriate regulatory authority, non-ILS approaches may be flown to the following minima:

- a published VNAV DA(H)
- a published MDA(H) used as a decision altitude.

737 NG Flight Crew Training Manual

If not specifically authorized to use the MDA(H) as a DA(H), use the MDA(H) specified for the instrument procedure being flown.

The following diagram illustrates an approach procedure containing DA(H) minimums for approaches using Localizer Performance with Vertical guidance (LPV) and LNAV/VNAV. The diagram also shows MDA(H) minimums for an approach using LNAV only and a circling approach.

STRAIGHT-IN LANDING RWY 28R							CIRCLE-TO-LAND	
LPV DA(H) 263' (250')		LNAV/VNAV DA(H) 822' (809')		LNAV MDA(H) 1040' (1027')		Max Kts	MDA(H)	
ALS out	ALS out	ALS out	ALS out	RVR	RVR			
A	RVR 24 or 1/2	RVR 40 or 3/4	2	2 3/4	RVR 40 or 3/4	RVR 60 or 1 1/4	90	1040' (1027') - 1 1/4
B					RVR 50 or 1	1 1/2	120	1040' (1027') - 1 1/2
C					2 1/4	2 1/2	140	1040' (1027') - 3
D					2 1/2	3	165	1060' (1147') - 3

Note: If using an MDA(H), the crew may wish to set the barometric minimums selector at MDA(H) + 50 feet. Initiating a missed approach approximately 50 feet above the MDA(H) may be necessary to avoid descending below the MDA(H) during the missed approach. This technique is an acceptable means of complying with the MDA(H) during constant angle non-ILS approaches with a CDFA.

When approaching DA(H) or MDA(H) the pilot monitoring should expand the instrument scan to include outside visual cues. Do not continue the approach below DA(H) or MDA(H) unless the airplane is in a position from which a normal approach to the runway of intended landing can be made and suitable visual reference can be maintained. Upon arrival at DA(H) or MDA(H) or any time thereafter, if any of the above requirements are not met, immediately execute the missed approach procedure.

The final approach is similar to the ILS final approach, however approaches using IAN do not support autoland. Therefore, when reaching the DA(H) or MDA(H), be prepared to land manually or execute an immediate go-around. If the approach is continued, be prepared to disengage the autopilot in accordance with regulatory requirements. Disconnect the autothrottle when disengaging the autopilot.

When suitable visual reference is established, maintain the glide path to the flare. Do not descend below the visual glide path. While glide path guidance may still be used as a reference once the airplane is below DA(H) or MDA(H), the primary means of approach guidance is visual.

Instrument Approach Using V/S

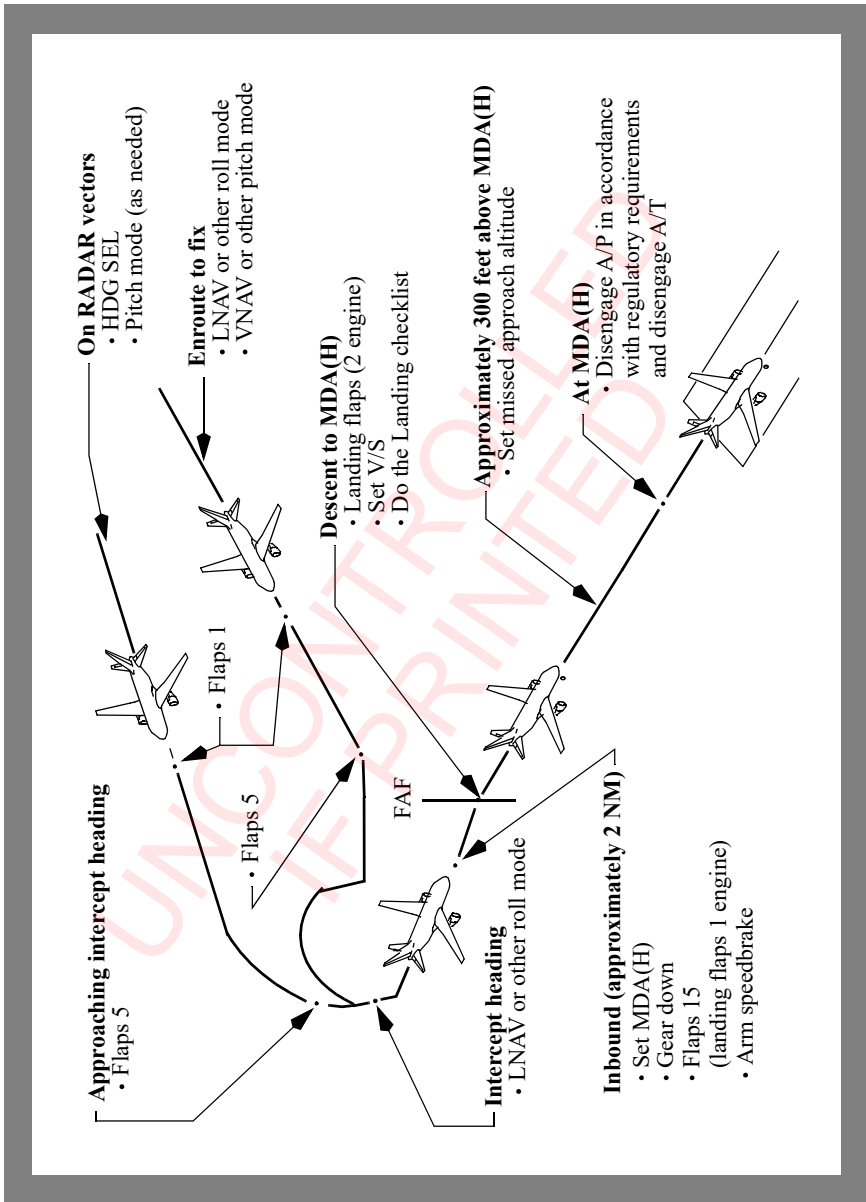

737 NG Flight Crew Training Manual

Approach Preparations for using V/S

Select the approach procedure from the arrivals page of the FMC. Tune and identify appropriate nav aids. If additional waypoint references are desired, use the FIX page. To enable proper LNAV waypoint sequencing, select a straight-in intercept course to the FAF when being radar vectored to final approach.

Verify/enter the appropriate RNP and set the MDA(H) using the baro minimums selector. If required to use MDA(H) for the approach minimum altitude, the barometric minimums selector may be set at MDA(H) + 50 feet to ensure that if a missed approach is initiated, descent below the MDA(H) does not occur during the missed approach.

Final Approach using V/S

Approaching intercept heading, select flaps 5. When established on an intercept heading, select LNAV or other appropriate roll mode. Approaching the FAF (approximately 2 NM), set the MCP altitude window to the first intermediate altitude constraint, or MDA(H) if no altitude constraint exists. Select gear down, flaps 15, arm the speedbrake and adjust speed.

Note: If desired altitude is not at an even 100 foot increment, set the MCP altitude to the nearest 100 foot increment above the altitude constraint or MDA(H).

When initiating descent to MDA(H), select landing flaps, slow to final approach speed and do the Landing checklist. If the charted FAF is too close to the runway to permit a stabilized approach, consider establishing final approach pitch mode and configuring for approach and landing earlier than specified in the FCOM procedure.

At or after the FAF, select V/S mode and descend at appropriate vertical speed to arrive at the MDA(H) at a distance from the runway (VDP) to allow a normal landing profile. Initial selection of an appropriate V/S should be made considering the recommended vertical speeds that are published on the approach chart, if available. These recommended vertical speeds vary with the airplane's ground speed on final approach. If no recommended vertical speeds are available, set approximately -700 to -800 fpm.

When stabilized in a descent on final approach, use one of the following techniques to make small incremental changes to the resulting vertical speed to achieve a constant angle descent to minimums. There should be no level flight segment at minimums.

Several techniques may be used to achieve a constant angle path that arrives at MDA(H) at or near the VDP:

- the most accurate technique is to monitor the VNAV path deviation indication on the map display and adjust descent rate to maintain the airplane on the appropriate path. This technique requires the path to be defined appropriately on the legs page and that the header GPx.xx is displayed for the missed approach point or there is a RWxx, MXxx, or named waypoint on the legs page with an altitude constraint which corresponds to approximately 50 feet threshold crossing height. When this method is used, crews must ensure compliance with each minimum altitude constraint on the final approach segment (step-down fixes)
- select a descent rate that places the altitude range arc at or near the step-down fix or visual descent point (VDP). This technique requires the step-down fix or MDA(H) to be set in the MCP and may be difficult to use in turbulent conditions. See the Visual Descent Point section for more details on determining the VDP
- using 300 feet per NM for a 3° path, determine the desired HAA which corresponds to the distance in NM from the runway end. The PM can then call out recommended altitudes as the distance to the runway changes (Example: 900 feet - 3 NM, 600 feet - 2 NM, etc.). The descent rate should be adjusted in small increments for significant deviations from the nominal path.

Be prepared to land or go-around from the MDA(H) at the VDP. Note that a normal landing cannot be completed from the published missed approach point on many instrument approaches.

Approximately 300 feet above the MDA(H), select the missed approach altitude. Leaving the MDA(H), be prepared to disengage the autopilot in accordance with regulatory requirements. Disconnect the autothrottle when disengaging the autopilot. Turn both F/Ds OFF, then place both F/Ds ON. This eliminates unwanted commands for both pilots and allows F/D guidance in the event of a go-around. Complete the landing.

On the V/S approach, the missed approach altitude is set when 300 feet above the MDA(H) to use the guidance of the altitude range arc during the approach and to prevent altitude capture and destabilizing the approach. Since there is no below path alerting, keeping the MDA(H) set as long as possible is recommended to help prevent inadvertent descent below MDA(H).

737 NG Flight Crew Training Manual

Minimum Descent Altitude/Height (MDA(H))

When approaching MDA(H) the pilot monitoring should expand the instrument scan to include outside visual cues. Do not continue the approach below MDA(H) unless the airplane is in a position from which a normal approach to the runway of intended landing can be made and suitable visual reference can be maintained. Upon arrival at MDA(H) or any time thereafter, if any of the above requirements are not met, immediately execute the missed approach procedure.

When suitable visual reference is established, maintain the descent path to the flare. Do not descend below the visual glide path.

UNCONTROLLED
IF PRINTED

Instrument Approach - RNAV (RNP) AR

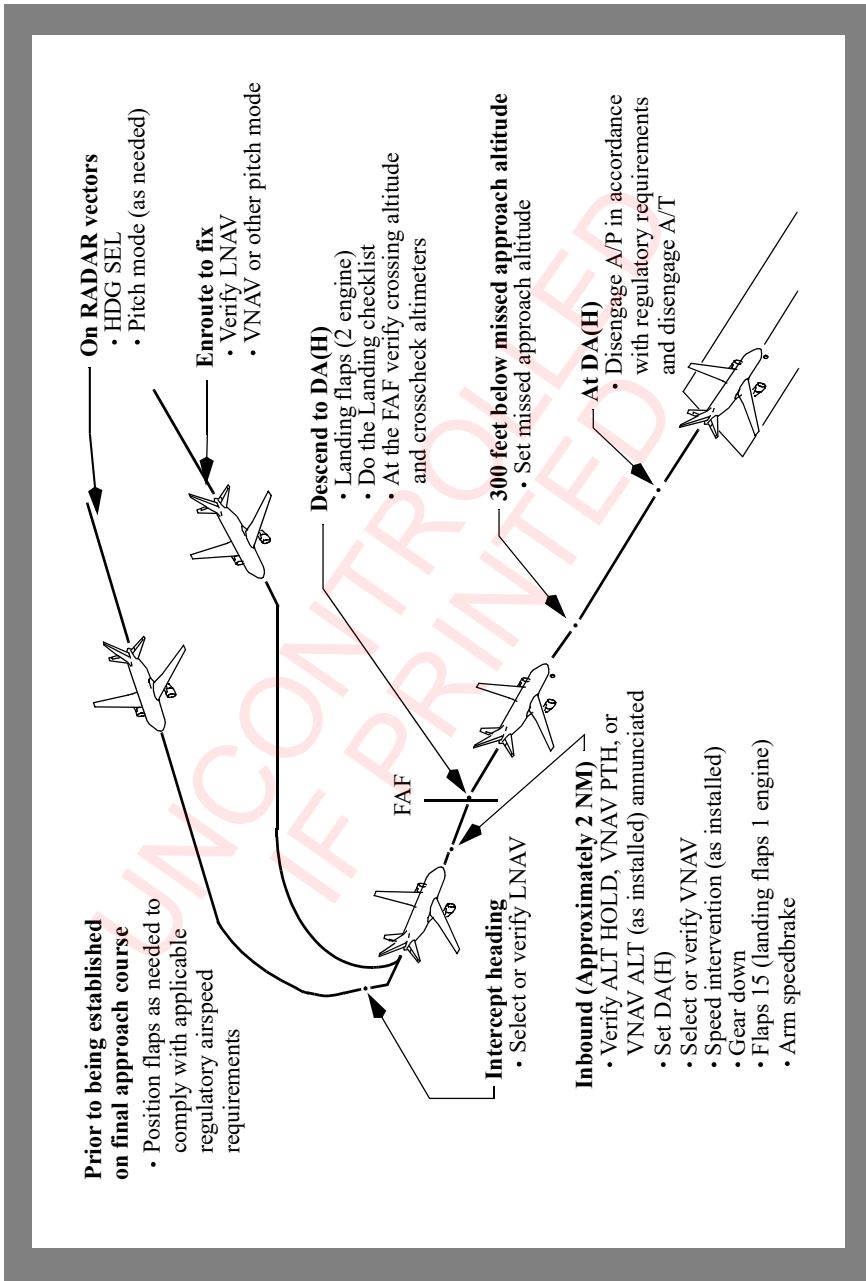

Instrument Approach - RNAV (RNP) AR - General**Appendix A.2.9**

This section applies only to operators who have approval to conduct RNAV (RNP) AR instrument approaches.

Approach Preparations using RNAV (RNP) AR

Select the approach procedure from the arrivals page of the FMC. If there is an “at or above” altitude restriction before the FAF, it may be changed to an “at” altitude restriction using the same altitude. Speed modifications are allowed as long as the maximum published speed is not exceeded.

Prior to beginning the approach, the crew must brief the approach and complete needed preparations. These include, but are not limited to, the following items, which may be included in an approach review card or other type of briefing aid:

- equipment that must be operational prior to starting the approach
- selection of the approach procedure, normally without modifications, from the navigation database
- for airplanes without NPS, one pilot should have the map display in the 10 NM or less range to monitor path tracking during the final approach segment
- for airplanes with NPS, the map display range may be set as the crew desires
- TERR display selected on at least one side
- RNP progress page displayed on the CDU, as needed. For airplanes equipped with NPS, selection of the CDU page is at the crew's discretion
- inhibiting of navigation radio updating, as needed. VOR/DME updating must always be OFF. DME-DME updating must be inhibited as needed.

Note: In US airspace, and other airspace where DME positioning has been verified to be adequate, DME-DME inhibiting is not required.

The crew must select or verify the approach RNP. If there are multiple RNPs published for the approach procedure, the RNP availability prediction obtained at dispatch or transmitted to the crew will determine the lowest value that can be used by the crew. The crew should note if RNP availability outages affect selection of any of the published RNP values. RNP availability restrictions, due to known satellite outages, terrain masking, or other factors, can sometimes affect the availability of lower RNPs (less than 0.15 nm) but will only rarely affect use of RNPs above 0.15 nm. The highest available RNP should be selected by the crew that is permitted by the prevailing weather conditions. Weather permitting, if the approach default RNP from the FMC is 0.3 nm and is a published RNP for the procedure, it should be used so that the FMC can automatically select the approach RNP and change to the missed approach RNP if a missed approach is needed. Crew entry of the RNP will prevent automatic RNP changes until the crew deletes the RNP entry.

For airplanes with NPS, verify that the vertical RNP is 125 feet. While there are no vertical RNP values published on the approach chart, the use of 125 feet will cause the NPS amber deviation exceedance alert to occur at 75 feet or slightly less deviation, since vertical ANP will be at least 50 feet at all times.

Ensure that there is no UNABLE REQD NAV PERF - RNP alert displayed before starting the approach. If the barometric pressure is changing rapidly, the crew should obtain an update and set the altimeter just before starting the approach.

Select LNAV no later than the IAF. If on radar vectors, select LNAV when established on an intercept heading to the final approach course. VNAV PTH must be engaged for all segments that contain a GP angle, as shown on the LEGS page, and must be selected no later than the FAF or published glide path intercept point.

Cold Temperature Altitude Corrections

In the design of RNP AR procedures, the allowable temperature range is normally specified and the procedure design accounts for operations and obstacle clearance for any temperature within the specified range. If the actual temperature is within the specified temperature range, the pilot can fly the RNP AR procedure and there are no temperature corrections needed. If the actual temperature is outside the specified temperature range, then the crew cannot fly the RNP AR procedure.

For airplanes with Temperature Compensation option, if the actual temperature is outside the specified temperature range, temperature correction is applied in accordance with applicable operationally approved procedure, as specified by the operator's regulatory authority or by the authority of the country in which the operation is conducted (including Air Traffic Control).

737 NG Flight Crew Training Manual

Final Approach using RNAV (RNP) AR

When initiating descent on the final approach path, select landing flaps, slow to final approach speed, and do the Landing checklist. Speed limits published on the approach chart must be complied with to enable adequate bank angle margins for the smaller radius-to-fix (RF) legs when strong winds exist. Bank angles will rarely exceed 15° when flying short radius RF legs unless the ground speed is very high due to strong tailwinds or high airplane speed.

The FMC and the alerting system monitors position accuracy and integrity through the RNP/ANP function so there is no need for the crew to monitor the reception of GPS signals or the ANP. If the GPS signal is lost during the approach due to loss of both GPS receivers or satellite position data, the ANP will grow and an UNABLE REQD NAV PERF - RNP alert occurs.

Once established on final approach, the RNAV (RNP) approach is flown like any other approach using LNAV and VNAV.

Maximum Lateral and Vertical Deviations for RNAV (RNP) AR Operations

RNP-based approach operations are normally designed to a lateral containment standard that equals twice the value of the RNP that is published for the procedure. To provide an adequate safety margin to account for path tracking errors, crews are expected to maintain course within 1.0 x RNP. For example, an RNP 0.15 approach will have a lateral containment limit of 0.30 nm, and a lateral deviation limit of 0.15 nm. Vertically, the deviation limit from the path is 75 feet, which only applies from the FAF to the missed approach point, unless the approach is annotated otherwise. Prior to the FAF, the vertical limit below the path is determined by the minimum altitude at the next (active) waypoint published on the approach chart. If a deviation above the path occurs, the crew should apply the criteria for a stabilized approach to determine the need for a missed approach.

For airplanes without NPS, the crew must refer to the FMC progress pages for XTK and VTK information during the approach. It is recommended that the PF and PM both monitor path tracking using the map display. During the final approach segment at least one pilot should have the map display in the 10 NM range. This range will allow monitoring the position trend vector and the track line for any excessive deviation from the magenta line. If a deviation occurs, and the correction back to course is not immediate, then the PM should refer to the FMC progress page and notify the PF if the maximum allowable deviations are reached.

For airplanes with NPS, the crew can refer to the NPS deviation indications. Full scale lateral and vertical deviation for NPS is equal to the FMC RNP value. If the deviation approaches the limit, an immediate correction back to the path is needed. If the deviation exceeds the limit or an amber deviation alert occurs, a missed approach is required unless the crew has suitable visual reference to continue to a landing. In the event of a missed approach for excessive deviation, the crew should continue to make corrections back to and maintain the required course.

For airplanes with FMC U14 or later, with or without NPS, anytime the UNABLE REQD NAV PERF-RNP is shown during the approach, regardless of whether or not the lateral or vertical RNP are exceeded, do the prescribed Go-Around and Missed Approach procedure unless suitable visual reference is established and maintained.

Visual Descent Point

For a non-ILS approach, the VDP is defined as the position on final approach from which a normal descent from the MDA(H) to the runway touchdown point may be initiated when suitable visual reference is established. If the airplane arrives at the VDP, a stabilized visual segment is much easier to achieve since little or no flight path adjustment is required to continue to a normal touchdown.

VDPs are indicated on some non-ILS/non-GLS approach charts by a “V” symbol. The distance to the runway is shown below the “V” symbol. If no VDP is given, the crew can determine the point where to begin the visual descent by determining the height above the airport (HAA) of the MDA(H) and use 300 feet per NM distance to the runway.

In the following example, an MDA(H) of 550 feet MSL with a 100 feet touchdown zone elevation results in a HAA of 450 feet. At 300 feet per NM, the point to begin the visual descent is 1 ½ NM distance from the runway.

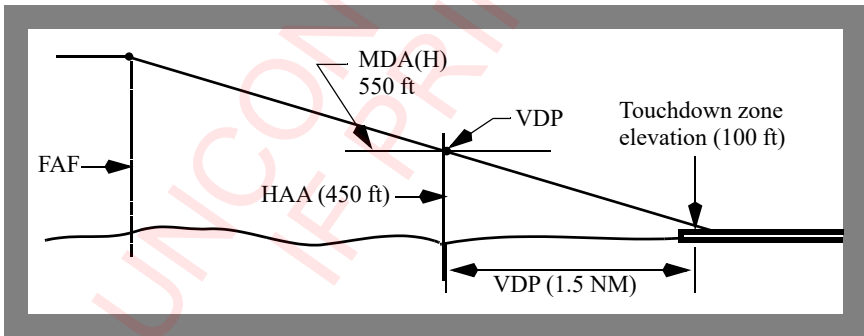

Most VDPs are between 1 and 2 NM from the runway. The following table provides more examples.

HAA (feet)	300	400	450	500	600	700
VDP Distance, NM	1.0	1.3	1.5	1.7	2.0	2.3

Note: If flying a VNAV path approach and the airplane remains on the published path, then the VDP is automatically complied with when the airplane arrives at the DA(H) or MDA(H). It is not necessary to determine the point to begin the visual descent for VNAV path approaches for this reason.

737 NG Flight Crew Training Manual

When flying an instrument approach using V/S, if the pilot adjusts the altitude range arc to approximately the VDP distance in front of the runway by varying the vertical speed, the airplane will remain close to or on the proper path for typical non-ILS approaches.

Missed Approach - Non-ILS

Refer to Go-Around and Missed Approach - All Approaches, this chapter.

UNCONTROLLED
IF PRINTED

Circling Approach

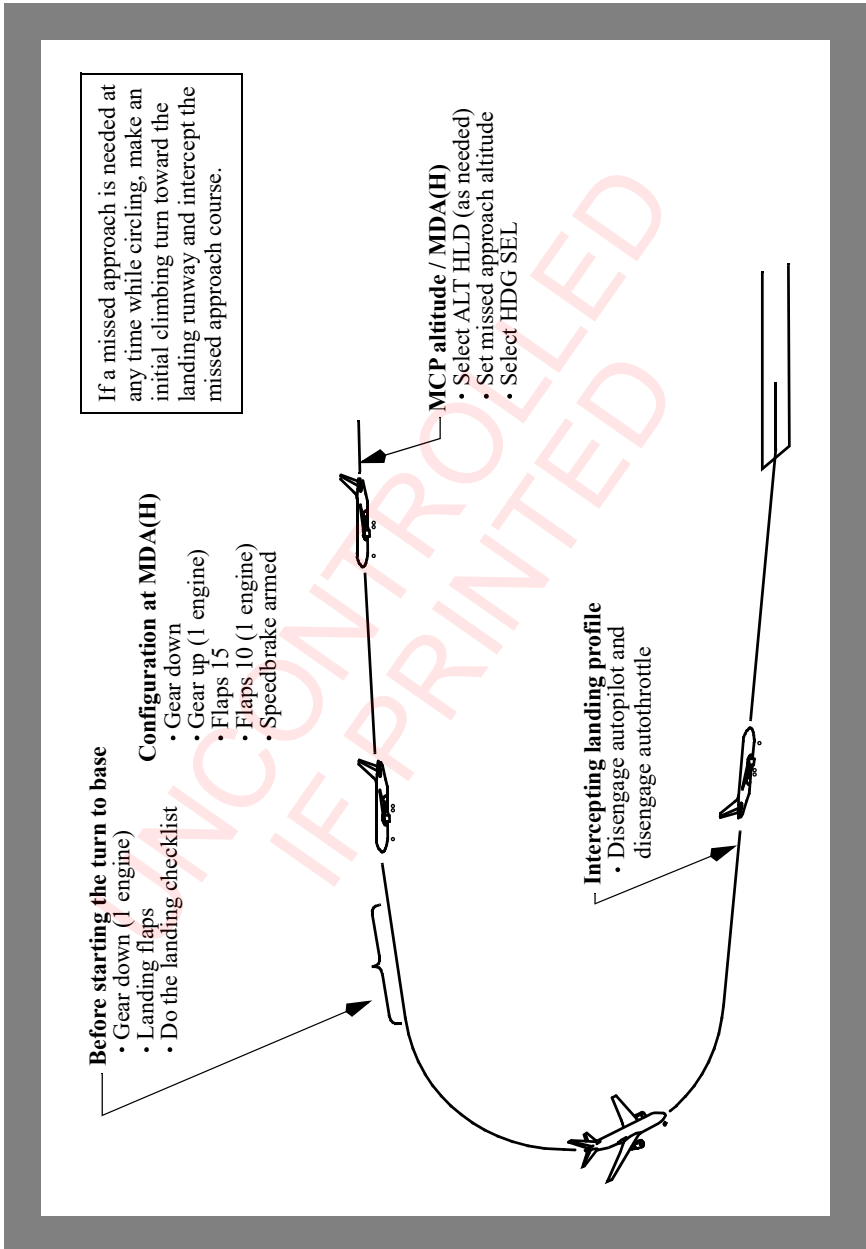

Circling Approach - General

The circling approach should be flown with landing gear down, flaps 15, and at flaps 15 maneuver speed. Use the weather minima associated with the anticipated circling speed.

The circling approach may be flown following any instrument approach procedure. During the instrument approach, use VNAV or V/S modes to descend to the circling MDA(H). Use of the APP mode for descent to the circling MDA(H) is not recommended for several reasons:

- the AFDS does not level off at MCP altitude
- exiting the APP mode requires initiating a go-around or disengaging the autopilot and turning off the flight directors.

Maintain MCP altitude or MDA(H) using ALT HOLD or VNAV ALT (as installed) mode. Use HDG SEL for the maneuvering portion of the circling approach.

Note: If the MDA(H) does not end in “00”, set the MCP altitude to the nearest 100 feet above the MDA(H) and circle at MCP altitude.

Note: If VNAV ALT (as installed) is allowed to remain as the pitch mode during the circling maneuver with a higher altitude, (e.g., missed approach altitude), set in the MCP, the VNAV ALT pitch mode will revert to CWS P.

When in ALT HOLD at MCP altitude or the MDA(H) and before commencing the circling maneuver, set the missed approach altitude.

Before starting the turn to base leg, select landing flaps and begin decelerating to the approach speed plus wind additive. To avoid overshooting the final approach course, adjust the turn to final to initially aim at the inside edge of the runway threshold. Timely speed reduction also reduces turning radius to the runway. Do the Landing checklist. Do not descend below MDA(H) until intercepting the visual descent profile to the landing runway.

When intercepting the landing profile, disengage the autopilot, disconnect the autothrottle and continue the approach manually. At this point in the approach, the pilot's attention should be focused on intercepting the visual descent profile rather than attempting to set the MCP or FMC to allow continued use of the autopilot. After intercepting the visual descent profile, cycle both F/D to OFF, then to ON. This eliminates unwanted commands for both pilots and allows F/D guidance in the event of a go-around. Complete the landing.

Note: If a go-around is selected with either flight director switch in the OFF position, the flight director pitch or roll command bar on the corresponding side will disappear when the first pitch or roll mode is selected or engaged.

Obstruction Clearance

Obstruction clearance areas during the circling approach are depicted in the following figure. Distances are determined by the maximum IAS during the circling approach and are depicted in the table following the figure.

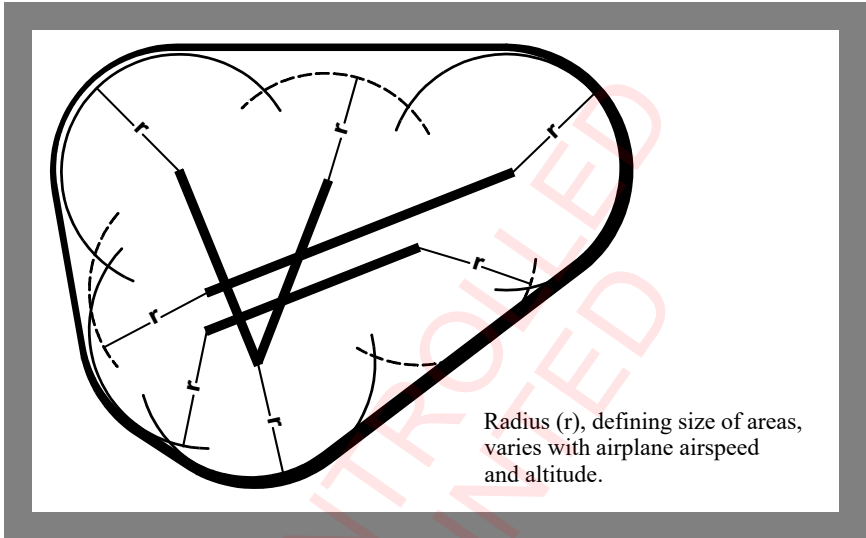

FAA	
Maximum IAS	Circling Area Radius (r) from Threshold
140 Kts	1.7 NM
165 Kts	2.3 NM

ICAO	
Maximum IAS	Circling Area Radius (r) from Threshold
180 Kts	4.2 NM
205 Kts	5.28 NM

Note: Adjust airplane heading and timing so that the airplane ground track does not exceed the obstruction clearance distance from the runway at any time during the circling approach.

737 NG Flight Crew Training Manual

FAA Expanded Circling Maneuvering Airspace Radius

The FAA has modified the criteria for circling approach areas via TERPS. Circling approach areas for approach procedures developed beginning in 2013 use the radius distances (in NM) as depicted in the following table. These distances, dependent on aircraft category, are also based on the circling altitude which accounts for the true airspeed increase with altitude.

Circling MDA in feet MSL	Circling Area Radius (r) from Threshold (NM)	
	Cat C Max 140 KIAS	Cat D Max 165 KIAS
1,000 or less	2.7	3.6
1,001 to 3,000	2.8	3.7
3,001 to 5,000	2.9	3.8
5,001 to 7,000	3.0	4.0
7,001 to 9,000	3.2	4.2
9,000 and above	3.3	4.4

Effect on Charts

Charts where the new criteria have been applied can be identified by the "Inverse C" icon in the CIRCLE-TO-LAND minima box as shown in the following table.

CIRCLE-TO-LAND Circling not authorized East of Rwy 3R/21L.	
Max Kts.	MDA(H)
90	1580' (495') -1
120	1580' (495') -1½
140	1580' (495') -1½
165	1640' (555') -2

It will take the FAA a number of years to update existing instrument approaches to the new criteria and apply the larger circling area dimensions. Circling minima not identified by the "Inverse C" icon continue to use the older circling area dimensions defined by the smaller radii. On these approaches, pilots must ensure that they do not base their circling maneuver on the larger airspace afforded by the new TERPS criteria and risk exceeding the circling protected airspace during the circling maneuver.

Circling Approach - One Engine Inoperative

If a circling approach is anticipated, maintain gear up, flaps 10, and flaps 10 maneuver speed from the final approach fix until just before starting the turn to base leg. As an option, use flaps 5, and flaps 5 maneuver speed as the approach flaps setting for the circling approach. Before starting the turn to base leg, select gear down and flaps 15 and begin reducing speed to VREF 15 plus wind additive. Do not descend below MDA(H) until intercepting the visual descent profile.

Missed Approach - Circling

If a missed approach is required at any time while circling, make a climbing turn in the shortest direction toward the landing runway. This may result in a turn greater than 180° to intercept the missed approach course. Continue the turn until established on an intercept heading to the missed approach course corresponding to the instrument approach procedure just flown. Maintain the missed approach flap setting until close-in maneuvering is completed.

Different patterns may be required to become established on the prescribed missed approach course. This depends on airplane position at the time the missed approach is started. The following figure illustrates the maneuvering that may be required. This ensures the airplane remains within the circling and missed approach obstruction clearance areas.

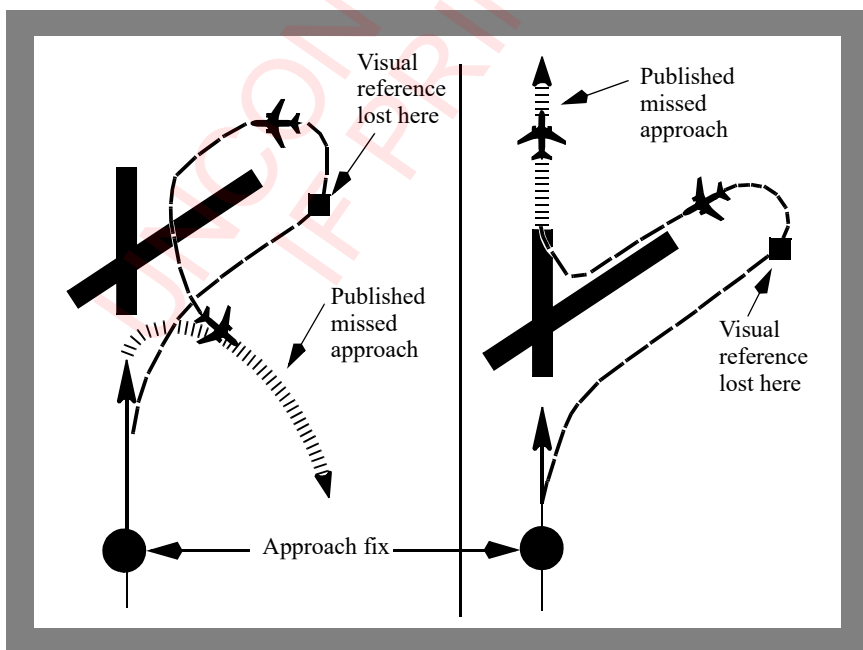

737 NG Flight Crew Training Manual

In the event that a missed approach must be accomplished from below the MDA(H), consideration should be given to selecting a flight path which assures safe obstacle clearance until reaching an appropriate altitude on the specified missed approach path.

Refer to Go-Around and Missed Approach - All Approaches, this chapter.

UNCONTROLLED
IF PRINTED

Visual Traffic Pattern

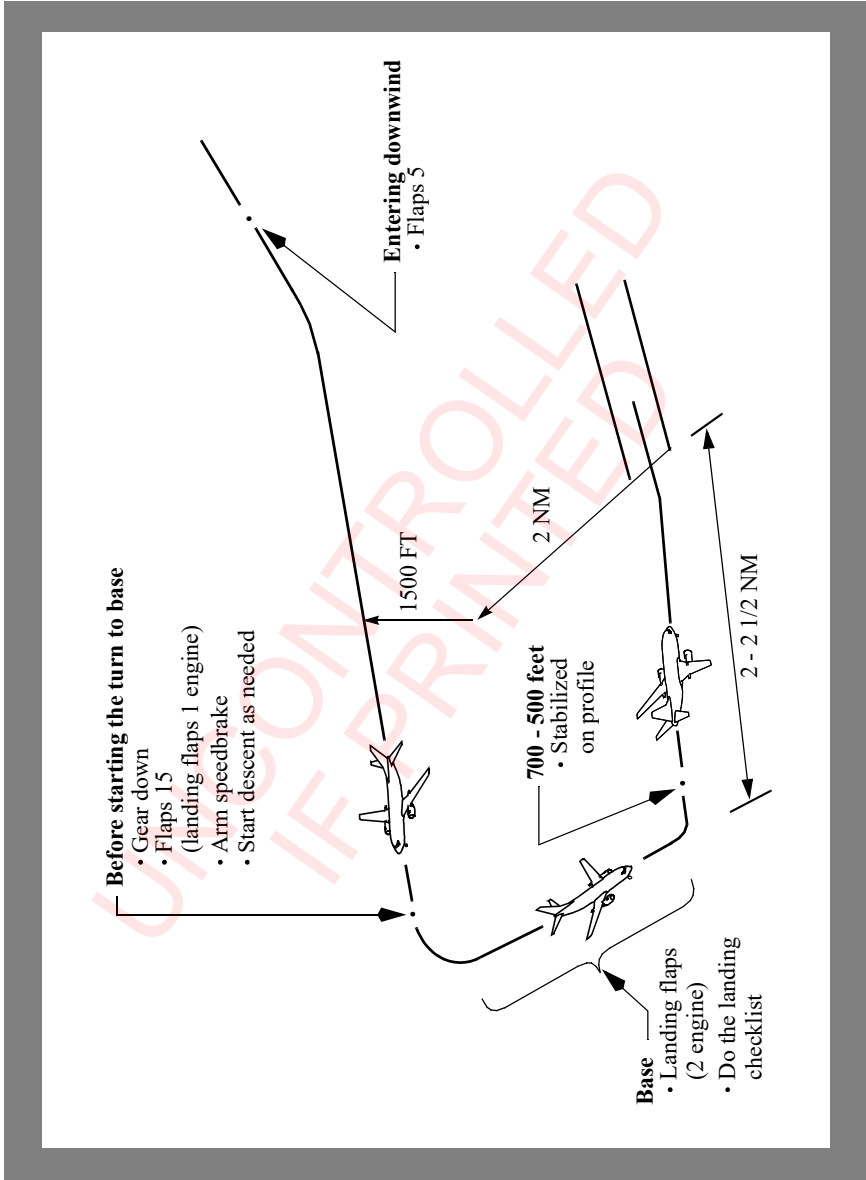

Visual Approach - General

The recommended landing approach path is approximately $2\ 1/2^\circ$ to 3° . Once the final approach is established, the airplane configuration remains fixed and only small adjustments to the glide path, approach speed, and trim are necessary. This results in the same approach profile under all conditions.

Thrust

Engine thrust and elevators are the primary means to control attitude and rate of descent. Adjust thrust slowly using small increments. Sudden large thrust changes make airplane control more difficult and are indicative of an unstable approach. No large changes should be necessary except when performing a go-around. Large thrust changes are not required when extending landing gear or flaps on downwind and base leg. A thrust increase may be required when stabilizing on speed on final approach.

Downwind and Base Leg

Typically fly at an altitude of 1,500 feet above the runway elevation and enter downwind with flaps 5 at flaps 5 maneuver speed. Maintain a track parallel to the landing runway approximately 2 NM abeam.

Before starting the turn to base leg, extend the landing gear, select flaps 15, arm the speedbrake, and slow to flaps 15 maneuver speed or approach speed plus wind additive if landing at flaps 15. If the approach pattern must be extended, delay lowering gear and selecting flaps 15 until approaching the normal visual approach profile. Turning base leg, adjust thrust as required while descending at approximately 600-700 fpm.

Extend landing flaps before turning final. Allow the speed to decrease to the proper final approach speed and trim the airplane. Do the Landing checklist. When established in the landing configuration, maneuvering to final approach may be accomplished at final approach speed (VREF plus wind additive).

Final Approach

Roll out of the turn to final on the extended runway centerline and maintain the appropriate approach speed. An altitude of approximately 300 feet AFE for each NM from the runway provides a normal approach profile. Attempt to keep thrust changes small to avoid large trim changes. With the airplane in trim and at approach airspeed, pitch attitude should be approximately the normal approach body attitude. At speeds above approach speed, pitch attitude is less. At speeds below approach speed, pitch attitude is higher. Slower speed reduces aft body clearance at touchdown. Stabilize the airplane on the selected approach airspeed with an approximate rate of descent between 700 and 900 feet per minute on the desired glide path, in trim. Stabilize on the profile by 500 feet above touchdown.

Note: Descent rates greater than 1,000 fpm should be avoided.

With one engine inoperative, the rudder trim may be centered before landing. This allows most of the rudder pedal pressure to be removed when the thrust of the operating engine is retarded to idle at touchdown.

Full rudder authority and rudder pedal steering capability are not affected by rudder trim. If touchdown occurs with the rudder still trimmed for the approach, be prepared for the higher rudder pedal forces required to track the centerline on rollout.

Engine Failure On Final Approach

In case of engine failure on visual final approach, use the procedure described in the ILS approach section, this chapter.

UNCONTROLLED
IF PRINTED

Touch and Go Landings

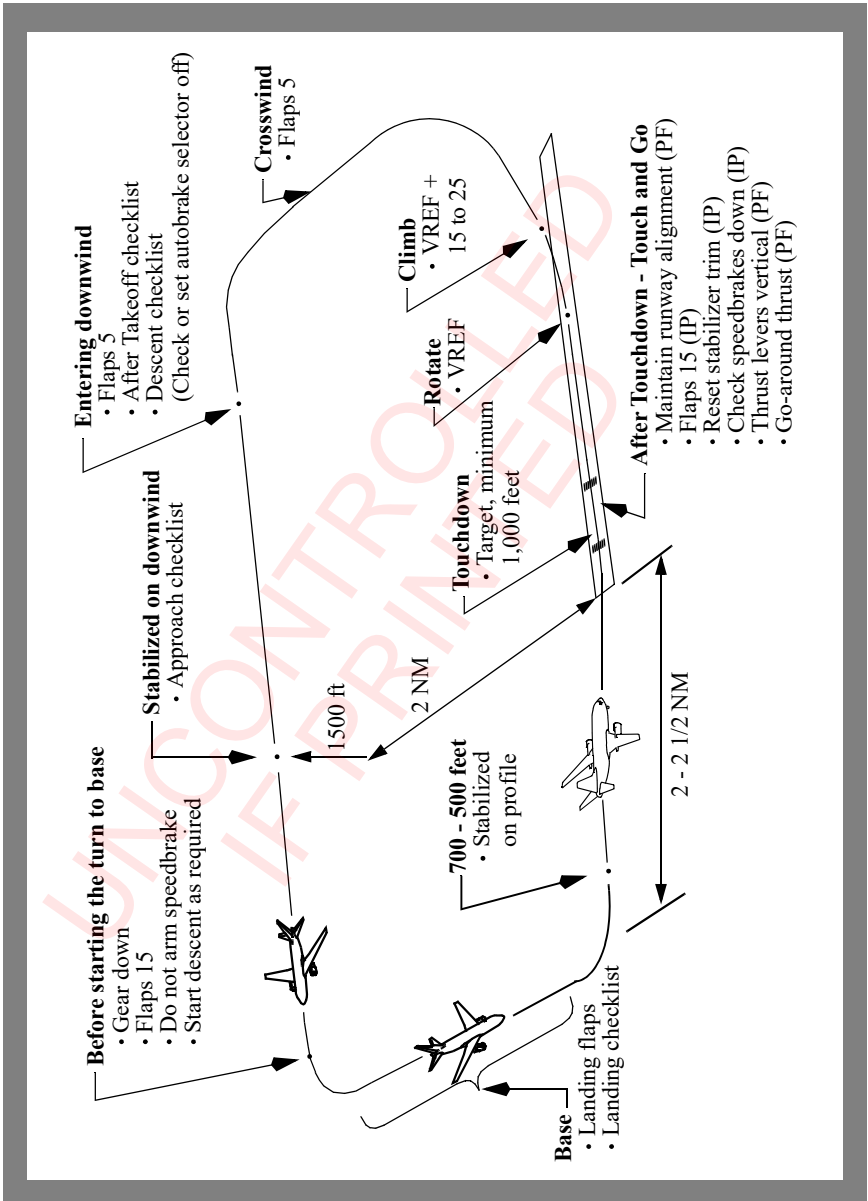

Touch and Go Landing - General

The primary objective of touch and go landings is approach and landing practice. It is not intended for landing roll and takeoff procedure training.

Approach

Accomplish the pattern and approach procedures as illustrated. For repetitive touch and go landings, leaving the landing gear extended throughout the maneuver will help prevent tire and brake overheating. However, be prepared to retract the landing gear if an actual engine failure occurs during go-around. Do not arm the speedbrakes. Select the autobrakes OFF.

Landing

The trainee should do a normal final approach and landing. After touchdown, the instructor selects flaps 15, sets stabilizer trim, ensures speedbrakes are down, and at the appropriate time instructs the trainee to move the thrust levers to approximately the vertical position (so engines stabilize before applying go-around thrust). When the engines are stabilized, the instructor instructs the trainee to set thrust.

Note: Flaps 15 is recommended after touchdown to minimize the possibility of a tail strike during the takeoff.

WARNING: After reverse thrust is initiated, a full stop landing must be made.

At VREF, the instructor calls "ROTATE" and the trainee rotates smoothly to approximately 15° pitch and climb at VREF + 15 to 25 knots. The takeoff configuration warning horn may sound momentarily if the flaps have not retracted to flaps 15 and the thrust levers are advanced to approximately the vertical position.

Stop and Go Landings

The objective of stop and go landings is to include landing roll, braking, and takeoff procedure practice in the training profile.

Note: At high altitude airports, or on extremely hot days, stop and go landings are not recommended.

After performing a normal full-stop landing, a straight ahead takeoff may be performed if adequate runway is available (FAR field length must be available). After stopping, and before initiating the takeoff, do the following:

- set takeoff flaps
- trim the stabilizer for takeoff
- place speedbrake lever in the down detent

737 NG Flight Crew Training Manual

- place autobrake to RTO
- check the rudder trim
- set airspeed bugs for the flap setting to be used.

Perform a normal takeoff.

Do not make repeated full stop landings without allowing time for brake cooling. Brake heating is cumulative and brake energy limits may be exceeded. Flat tires may result.

Note: Flying the pattern with the gear extended assists in tire and brake cooling.

UNCONTROLLED
IF PRINTED

Go-Around and Missed Approach - All Approaches (FMC U10.6 and earlier)

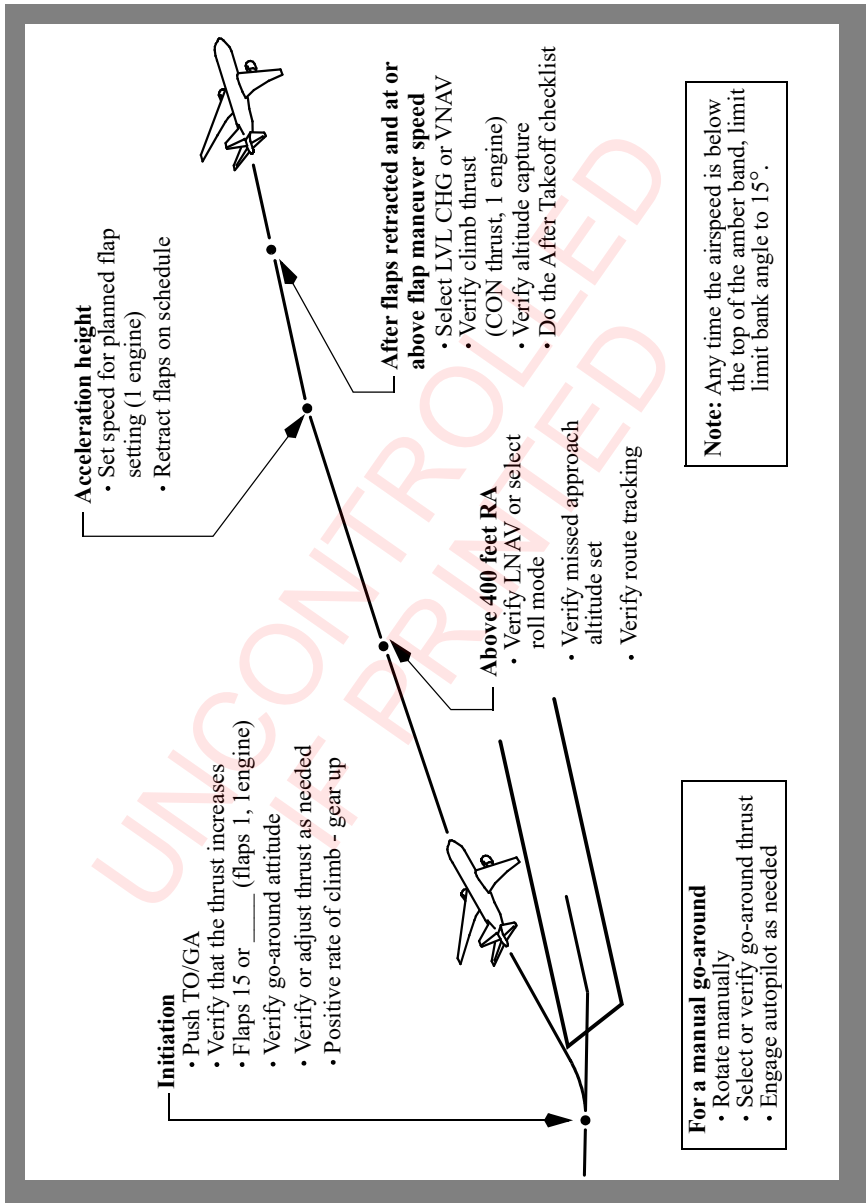

Go-Around and Missed Approach - All Approaches (FMC 10.7 and later)

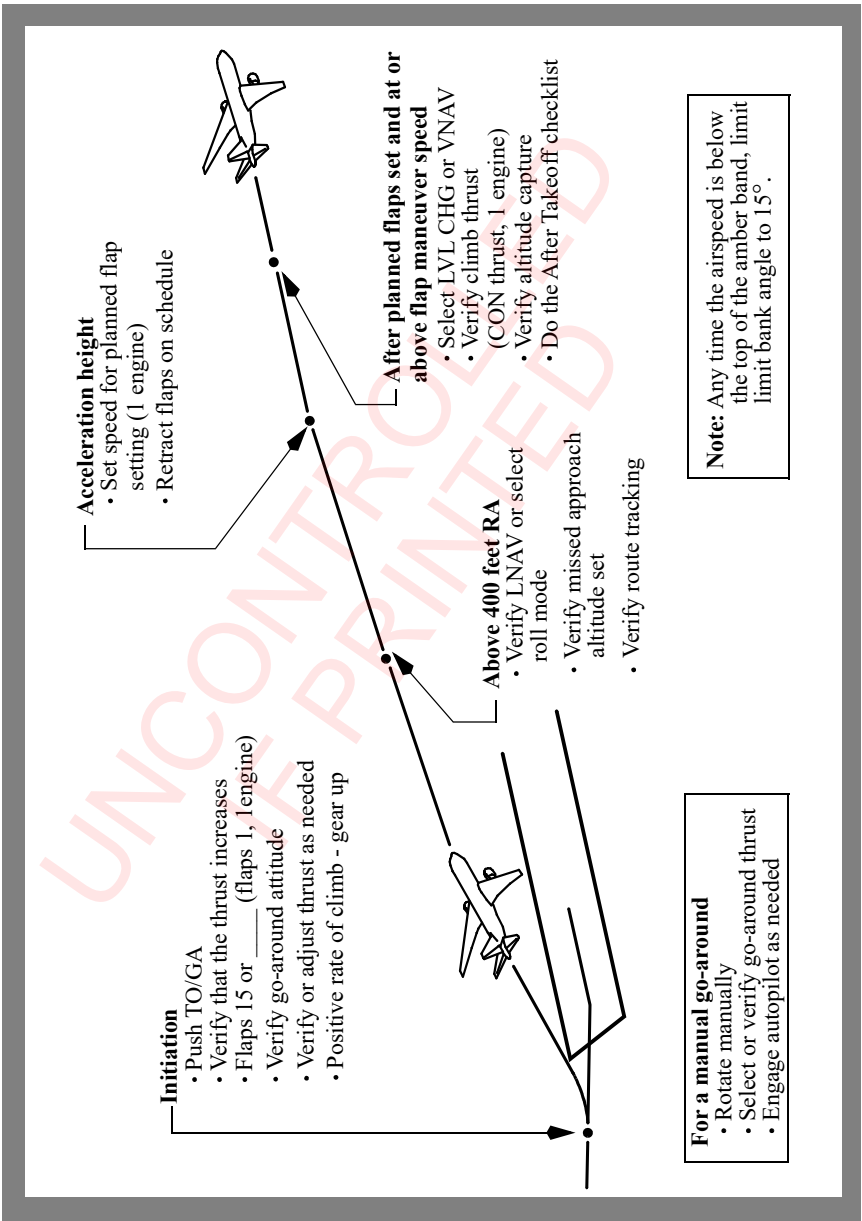

Go-Around and Missed Approach - All Engines Operating

The go-around and missed approach is generally performed in the same manner whether an instrument or visual approach was flown. The go-around and missed approach is flown using the Go-Around and Missed Approach procedure described in the FCOM. The discussion in this section supplements those procedures.

If a missed approach is required following a dual autopilot approach with FLARE arm annunciated, leave the autopilots engaged. Push either TO/GA switch, verify that the thrust increases, call for flaps 15 or flaps as needed, ensure go-around thrust for the nominal climb rate is set and monitor autopilot performance. Retract the landing gear after a positive rate of climb is indicated on the altimeter.

At typical landing weights, actual thrust required for a normal go-around is usually considerably less than maximum go-around thrust. This provides a thrust margin for windshear or other situations requiring maximum thrust. If full thrust is desired after thrust for the nominal climb rate has been established, push TO/GA a second time.

If a missed approach is required following a single autopilot or manual instrument approach, or a visual approach, push either TO/GA switch, call for flaps 15, ensure/set go-around thrust, and rotate smoothly toward 15° pitch attitude. Then follow flight director commands and retract the landing gear after a positive rate of climb is indicated on the altimeter.

Note: When performing a normal approach using flaps 15 for landing, if a go-around is required use flaps 15 for go-around. Authorized operators with appropriate performance data available, use flaps 1 for go-around if required for performance. When using flaps 1 for go-around, limit bank angle to 15° when airspeed is less than VREF 15 + 15 knots or minimum maneuver speed, whichever is less.

During an automatic go-around initiated at 50 feet, approximately 30 feet of altitude is lost. If touchdown occurs after a go-around is initiated, the go-around continues. Observe that the autothrottle applies go-around thrust or manually apply go-around thrust as the airplane rotates to the go-around attitude.

Note: An automatic go-around cannot be initiated after touchdown.

737 NG Flight Crew Training Manual

The TO/GA pitch mode initially commands a go-around attitude and then transitions to speed as the rate of climb increases. Command speed automatically moves to a target airspeed for the existing flap position. The TO/GA roll mode maintains existing ground track. Above 400 feet AGL, verify that LNAV is engaged for airplanes equipped with the TO/GA to LNAV feature, or select a roll mode as appropriate.

Note: Route discontinuities after the missed approach point will prevent the TO/GA to LNAV function from engaging.

The minimum altitude for flap retraction during a normal takeoff is not normally applicable to a missed approach procedure. However, obstacles in the missed approach flight path must be taken into consideration. During training, use 1,000 feet AGL to initiate acceleration for flap retraction.

Note: Other pitch and roll modes cannot be engaged until above 400 feet AGL.

Note: When accomplishing a missed approach from a dual-autopilot approach, initial selection of a pitch mode, or when altitude capture occurs above 400 feet AGL the autopilot reverts to single autopilot operation.

If initial maneuvering is required during the missed approach, do the missed approach procedure through gear up before initiating the turn. Delay further flap retraction until initial maneuvering is complete and a safe altitude and appropriate speed are attained.

Command speed automatically increases to the maneuver speed for the existing flap position. Retract flaps on the normal flap/speed schedule. For airplanes with FMC update U10.6 and earlier when the flaps are retracted to the desired position and the airspeed is at or above the flap maneuver speed, select LVL CHG and ensure climb thrust is set. VNAV may be selected if the flaps are up. Verify the airplane levels off at selected altitude and proper speed is maintained.

Command speed automatically increases to the maneuver speed for the existing flap position. Retract flaps on the normal flap/speed schedule. For airplanes with FMC U10.7 and later when the flaps are set to the desired position and the airspeed is at or above the flap maneuver speed, select LVL CHG or VNAV and ensure climb thrust is set. Verify the airplane levels off at selected altitude and proper speed is maintained.

If VNAV is used during go-around, the FMC missed approach profile should contain the appropriate holding speeds and altitudes. Speed intervention (as installed) may be used to further modify airspeed as needed. If VNAV ALT (as installed) is displayed, a premature level off may occur and selection of LVL CHG may be required to complete the climb to the missed approach altitude.

Low Altitude Level Off - Low Gross Weight

When accomplishing a low altitude level off following a go-around at a low gross weight, the crew should consider the following factors:

- if full go-around thrust is used, altitude capture can occur just after the go-around is initiated due to the proximity of the level off altitude and the high climb rate of the airplane
- the AFDS control laws limit F/D and autopilot pitch commands for passenger comfort
- there may not be enough altitude below the intended level off altitude to complete the normal capture profile and an overshoot may occur unless crew action is taken.

To prevent an altitude and/or airspeed overshoot, the crew should consider doing one or more of the following:

- use the autothrottle
- push TO/GA switch once to command thrust sufficient for a 1,000 to 2,000 fpm climb rate
- if full go-around thrust is used, reduce to climb thrust earlier than normal
- disconnect the AFDS and complete the level off manually if there is a possibility of an overshoot
- if the autothrottle is not available, be prepared to use manual thrust control as needed to manage speed and prevent flap overspeed.

Go-Around after Touchdown

Note: Refer to chapter 6, Landing, for further discussion regarding Rejected Landing and Balked Landing recommendations and guidance.

If a go-around is initiated before touchdown and touchdown occurs, continue with normal go-around procedures or rejected landing/balked landing guidance. The F/D go-around mode will continue to provide go-around guidance commands throughout the maneuver. The takeoff configuration warning horn may sound momentarily if the flaps have not retracted to flaps 15 and the thrust levers are advanced.

Note: When landing, the TO/GA switches are inhibited near touchdown and on the ground. Refer to the FCOM, Automatic Flight chapter for details.

737 NG Flight Crew Training Manual

If a go-around is initiated after touchdown but before thrust reverser selection, continue with normal go-around procedures or bailed landing guidance. As thrust levers are advanced verify auto speedbrakes retract and autobrakes disarm. The F/D go-around mode will continue to provide go-around guidance commands throughout the maneuver.

Note: The F/D pitch command is not used for rotation.

WARNING: Once reverse thrust is initiated following touchdown, a full stop landing must be made. If an engine stays in reverse, safe flight is not possible.

Go-Around and Missed Approach - One Engine Inoperative

If a missed approach is accomplished from a flaps 15 approach, use flaps 1 for the go-around flap setting. After TO/GA is engaged, the AFDS initially commands a go-around attitude, then transitions to maintain command speed as the rate of climb increases. The pilot must control yaw with rudder and trim. Some rudder pedal pressure may be required even with full rudder trim. Select maximum continuous thrust when flaps are retracted to the desired flap setting.

For fail operational airplanes, if a missed approach is accomplished from a flaps 30 approach, perform a flaps 15 go-around. Follow Go-Around and Missed Approach procedures. After TO/GA is engaged, the AFDS initially commands a go-around attitude, then transitions to maintain command speed as the rate of climb increases. If the missed approach is initiated after LAND 3 or LAND 2 is annunciated, yaw is initially controlled by the autopilot. Be prepared to immediately apply rudder input when selecting another roll mode, pitch mode, or when altitude capture occurs above 400 feet AGL because the autopilot reverts to single autopilot operation and automatic control of the rudder is discontinued.

Note: After the system reverts to normal (single) autopilot operation, the autothrottle should be disconnected.

Engine Failure During Go-Around and Missed Approach

If an engine fails during go-around, perform normal Go-Around and Missed Approach procedures. Verify maximum go-around thrust is set. Maintain flaps 15, VREF 30 or 40 plus wind additive (5 knots minimum) speed and limit bank angle to 15° until initial maneuvering is complete and a safe altitude is reached. Accelerate to flap retraction speed by repositioning the command speed to the maneuver speed for the desired flap setting and adjusting pitch. Retract flaps on the normal flap/speed schedule.

Note: VREF 30 or 40 plus wind additive at flaps 15 may result in an airspeed that provides less than full maneuver margin (top of the amber band).



Intentionally
Blank

UNCONTROLLED
IF PRINTED



Landing

Chapter 6

Table of Contents

Section TOC

Preface 6.1

Visual Approach Slope Indicator (VASI/T - VASI) 6.1

 Three Bar VASI/T - VASI 6.2

 VASI Landing Geometry 6.3

Precision Approach Path Indicator 6.5

 PAPI Landing Geometry 6.5

Landing Geometry 6.5

 Visual Aim Point 6.5

 Runway Markings (Typical) 6.6

 Threshold Height 6.7

Flare and Touchdown 6.7

 Airspeed Control 6.8

 Landing Flare Profile 6.8

 Flare and Touchdown using HUD System 6.9

 Normal Touchdown Attitude 6.10

 Pitch and Roll Limit Conditions 6.25

 Bounced Landing Recovery 6.29

Rejected Landing / Balked Landing 6.30

 Rejected Landing 6.30

 Balked Landing 6.30

 Hard Landing 6.32

Landing Roll 6.32

 Speedbrakes 6.32

 Directional Control and Braking during Landing Roll 6.33

 Factors Affecting Landing Distance 6.33

 Wheel Brakes 6.38



Reverse Thrust Operation	6.42
Crosswind Landings	6.46
Landing Crosswind Guidelines	6.46
Crosswind Landing Techniques	6.48
Overweight Landing	6.50
Overweight Autolands Policy	6.51

UNCONTROLLED
IF PRINTED



Preface

This chapter outlines recommended operating practices and techniques for landing, rejected landings and landing roll. Techniques are provided to help the pilot effectively utilize approach lighting, control the airplane during crosswind landings and maintain directional control after landing. Additionally, information on factors affecting landing distance and landing geometry is provided.

Visual Approach Slope Indicator (VASI/T - VASI)

The VASI is a system of lights arranged to provide visual descent guidance information during the approach. All VASI systems are visual projections of the approach path normally aligned to intersect the runway at a point 1,000 or 1,800 feet beyond the threshold. Flying the VASI glide slope to touchdown is the same as selecting a visual aim point on the runway adjacent to the VASI installation.

When using a two-bar VASI, the difference between the eye reference path and the gear path results in a normal approach and threshold height. It provides useful information in alerting the crew to low profile situations.

Some airports have a three-bar VASI which provides two visual glide paths. The additional light bar is located upwind from a standard two-bar installation. When the airplane is on the glide path, the pilot sees the one white bar and two red bars. Three-bar VASI may be safely used in relation to threshold crossing height, but may result in landing further down the runway.

For a T-VASI, flying the approach with one additional white fly down light visible provides additional wheel clearance.

Three Bar VASI/T - VASI

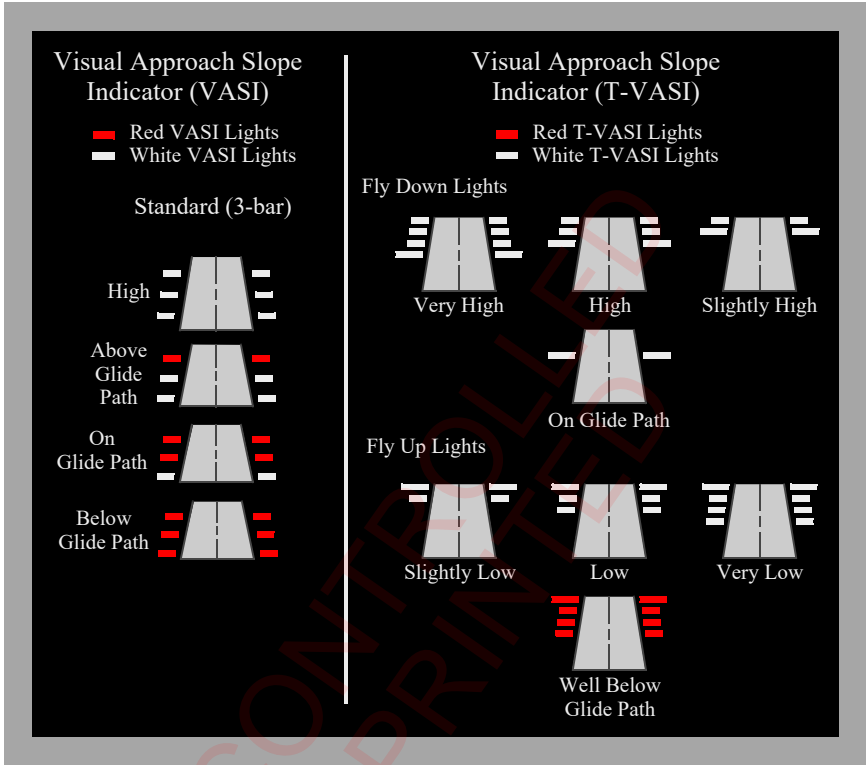

VASI Landing Geometry

Two-bar VASI installations provide one visual glide path which is normally set at 3°. Three-bar VASI installations provide two visual glide paths. The lower glide path is provided by the near and middle bars and is normally set at 3° while the upper glide path, provided by the middle and far bars, is normally 1/4° higher (3.25°). This higher glide path is intended for use only by high cockpit (long wheelbase) airplanes to provide a sufficient threshold crossing height.

Two Bar VASI Landing Geometry

The following diagrams use these conditions:

- data is based upon typical landing weight

737-800

- data for airplanes with a 1-position tail skid is shown before the “/”. Differences between the basic -800 with the 1-position tail skid and -800 airplanes with the short field performance option and a 1-position tail skid are negligible. Data for airplanes equipped with a 2-position tail skid is shown following the “/”.
- airplane body attitudes are based on flaps 30 and flaps 40, VREF (for the flap setting used) + 5 knots and should be reduced by 1° for each 5 knots above this speed.
- pilot eye height is measured when the main gear is over the threshold.

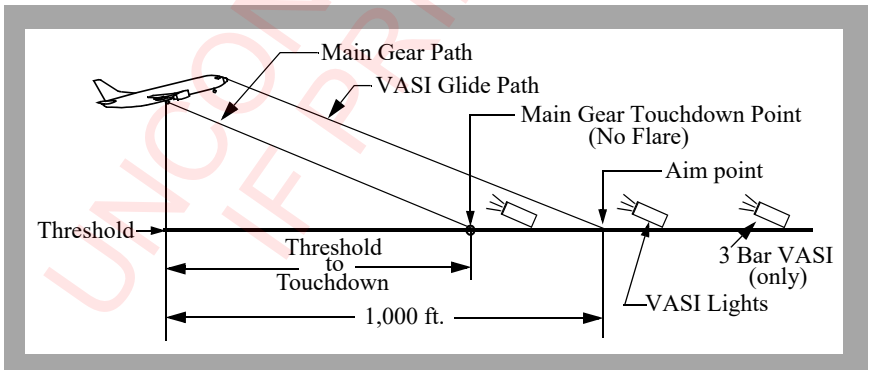

737 Model	Flaps 30		Main Gear over Threshold		Threshold to Main Gear Touchdown Point-No Flare (feet)
	Visual Glide Path (degrees)	Airplane Body Attitude (degrees)	Pilot Eye Height (feet)	Main Gear Height (feet)	
-600	3.0	3.7	50	36	657
-700	3.0	3.7	50	34	647



737 NG Flight Crew Training Manual

737 Model	Flaps 30		Main Gear over Threshold		Threshold to Main Gear Touchdown Point-No Flare (feet)
	Visual Glide Path (degrees)	Airplane Body Attitude (degrees)	Pilot Eye Height (feet)	Main Gear Height (feet)	
-800	3.0	2.4 / 3.6	49 / 50	34 / 33	651 / 633
-900	3.0	1.6	49	35	659
-900ER	3.0	2.6	49	34	641

737 Model	Flaps 40		Main Gear over Threshold		Threshold to Main Gear Touchdown Point-No Flare (feet)
	Visual Glide Path (degrees)	Airplane Body Attitude (degrees)	Pilot Eye Height (feet)	Main Gear Height (feet)	
-600	3.0	2.0	50	36	683
-700	3.0	2.0	50	35	675
-800	3.0	1.4 / 2.7	49 / 50	35 / 34	671 / 649
-900	3.0	0.9	49	34	644
-900ER	3.0	2.5	49	34	643

Precision Approach Path Indicator

The Precision Approach Path Indicator (PAPI) uses lights which are normally on the left side of the runway. They are similar to the VASI, but are installed in a single row of light units.

When the airplane is on a normal 3° glide path, the pilot sees two white lights on the left and two red lights on the right. The PAPI may be safely used in relation to threshold crossing height, but may result in landing further down the runway. The PAPI is normally aligned to intersect the runway 1,000 to 1,500 feet beyond the threshold.

PAPI Landing Geometry

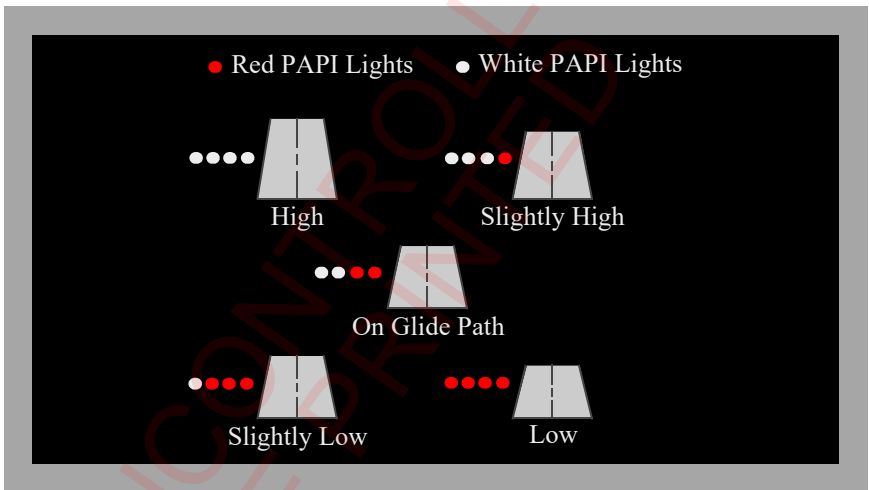

Landing Geometry

Visual Aim Point

During visual approaches many techniques and methods are used to ensure main landing gear touchdown at the desired point on the runway. One of the most common methods used is to aim at the desired gear touchdown point on the runway, then adjust the final approach glide path until the selected point appears stationary in relation to the airplane (the point does not move up or down in the pilot's field of view during the approach).

Visual aim points versus gear touchdown point differences increase as glide path angle decreases as in a flat approach. For a particular visual approach, the difference between gear path and eye level path must be accounted for by the pilot.

Threshold Height

Threshold height is a function of glide path angle and landing gear touchdown target. Threshold height for main gear and pilot eye level is shown in the Two Bar/Three Bar VASI Landing Geometry tables on a previous page. Special attention must be given to establishing a final approach that assures safe threshold clearance and gear touchdown at least 1,000 feet down the runway. If automatic callouts are not available, the radio altimeter should be used to assist the pilot in judging terrain clearance, threshold height and flare initiation height.

Flare and Touchdown

The techniques discussed here are applicable to all landings including one engine inoperative landings, crosswind landings and landings on slippery runways. Unless an unexpected or sudden event occurs, such as windshear or collision avoidance situation, it is not appropriate to use sudden, violent or abrupt control inputs during landing. Begin with a stabilized approach on speed, in trim and on glide path.

Note: When a manual landing is planned from an approach with the autopilot engaged, the transition to manual flight should be planned early enough to allow the pilot time to establish airplane control before beginning the flare. The PF should consider disengaging the autopilot and disconnecting the autothrottle 1 to 2 nm before the threshold, or approximately 300 to 600 feet above field elevation.

When the threshold passes out of sight under the airplane nose shift the visual sighting point to the far end of the runway. Shifting the visual sighting point assists in controlling the pitch attitude during the flare. Maintaining a constant airspeed and descent rate assists in determining the flare point. Initiate the flare when the main gear is approximately 20 feet above the runway by increasing pitch attitude approximately 2° - 3°. This slows the rate of descent.

After the flare is initiated, smoothly retard the thrust levers to idle, and make small pitch attitude adjustments to maintain the desired descent rate to the runway. A smooth thrust reduction to idle also assists in controlling the natural nose-down pitch change associated with thrust reduction. Hold sufficient back pressure on the control column to keep the pitch attitude constant. A touchdown attitude as depicted in the figure below is normal with an airspeed of approximately VREF. Ideally, main gear touchdown should occur simultaneously with thrust levers reaching idle.

Avoid rapid control column movements during the flare. If the flare is too abrupt and thrust is excessive near touchdown, the airplane tends to float in ground effect. Do not allow the airplane to float or attempt to hold it off. Fly the airplane onto the runway at the desired touchdown point and at the desired airspeed.

Note: Do not trim during the flare. Trimming in the flare increases the possibility of a tail strike.

Prolonged flare increases airplane pitch attitude 2° to 3° . When prolonged flare is coupled with a misjudged height above the runway, a tail strike is possible. Do not prolong the flare in an attempt to achieve a perfectly smooth touchdown. A smooth touchdown is not the criterion for a safe landing.

Typically, the pitch attitude increases slightly during the actual landing, but avoid over-rotating. Do not increase the pitch attitude, trim, or hold the nose wheel off the runway after landing. This could lead to a tail strike.

Airspeed Control

During an autoland, the autothrottle retards the thrust so as to reach idle at touchdown. The 5 knot additive is bled off during the flare.

If the autothrottle is disconnected, or is planned to be disconnected prior to landing, maintain reference speed plus any wind additive until approaching the flare. Minimum command speed setting is $VREF + 5$ knots. With proper flare technique and thrust management the 5 knot additive and some of the steady wind additive may be bled off prior to touchdown. Plan to maintain gust correction until touchdown. Touchdown should occur at no less than $VREF - 5$ knots.

All approach speed additives should be accounted for when determining the landing distance by applying the Approach Speed Adjustment from the Normal or Non-Normal Landing Distance table.

Landing Flare Profile

The following diagrams use these conditions:

- 3° approach glide path
- flare distance is approximately 1,000 to 2,000 feet beyond the threshold
- typical landing flare times range from 4 to 8 seconds and are a function of approach speed
- airplane body attitudes are based upon typical landing weights, flaps 30, $VREF 30 + 5$ knots (approach) and $VREF 30 + 0$ (touchdown), and should be reduced by 1° for each 5 knots above this speed
- threshold height for main gear and pilot eye level is shown in the Two Bar/Three Bar VASI Landing Geometry tables on preceding pages.

737 NG Flight Crew Training Manual

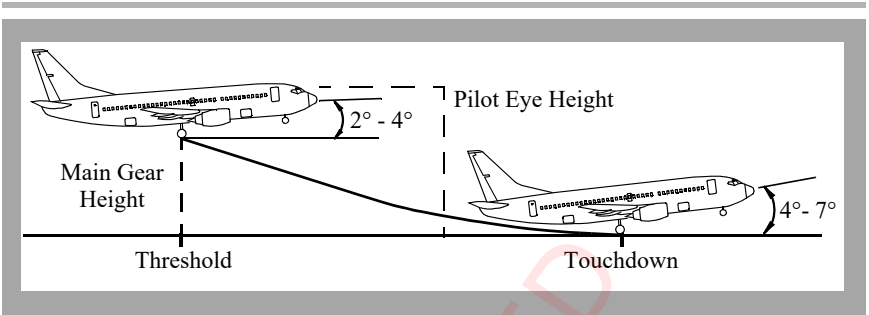

Flare and Touchdown using HUD System

For airplanes equipped with HUD, flare guidance is provided in the AIII mode. Follow the guidance cue and perform the flare and landing using HUD guidance and visual cues. Monitor the roll out annunciation (as installed) and transition to rollout guidance. Use normal procedures to decelerate to taxi speed.

UNCONTROLLED
IF PRINTED

Normal Touchdown Attitude

The following figures illustrate the effect of airspeed on airplane attitude at touchdown. They show airplane attitude at a normal touchdown speed (VREF to VREF - 5 knots) for flaps 30 and flaps 40. The figures also show that touchdown at a speed below normal touchdown speed, in this case VREF - 10 knots, seriously reduces aft body-runway clearance.

Conditions

- Forward CG limit
- Sea level standard day
- -150 fpm sink rate at touchdown

UNCONTROLLED
IF PRINTED

737 NG Flight Crew Training Manual

Touchdown Body Attitudes - Kilograms

737-600

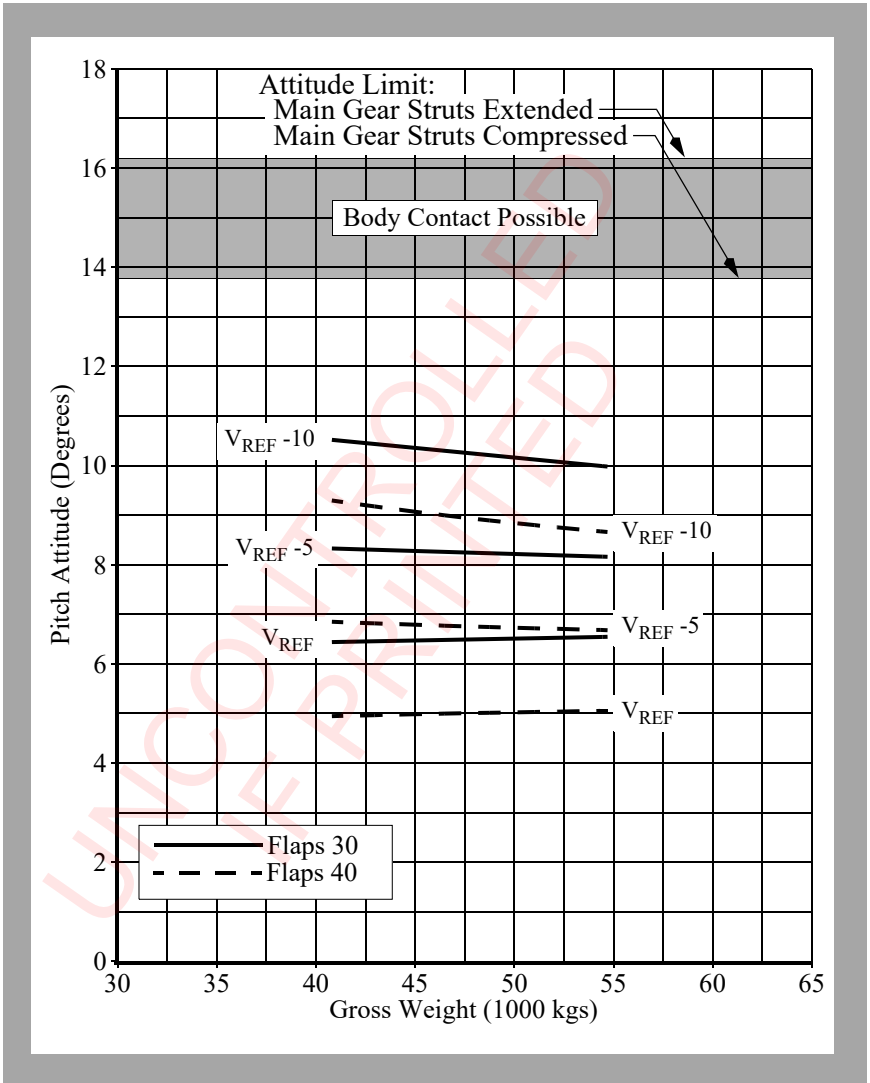

Touchdown Body Attitudes - Kilograms

737-700

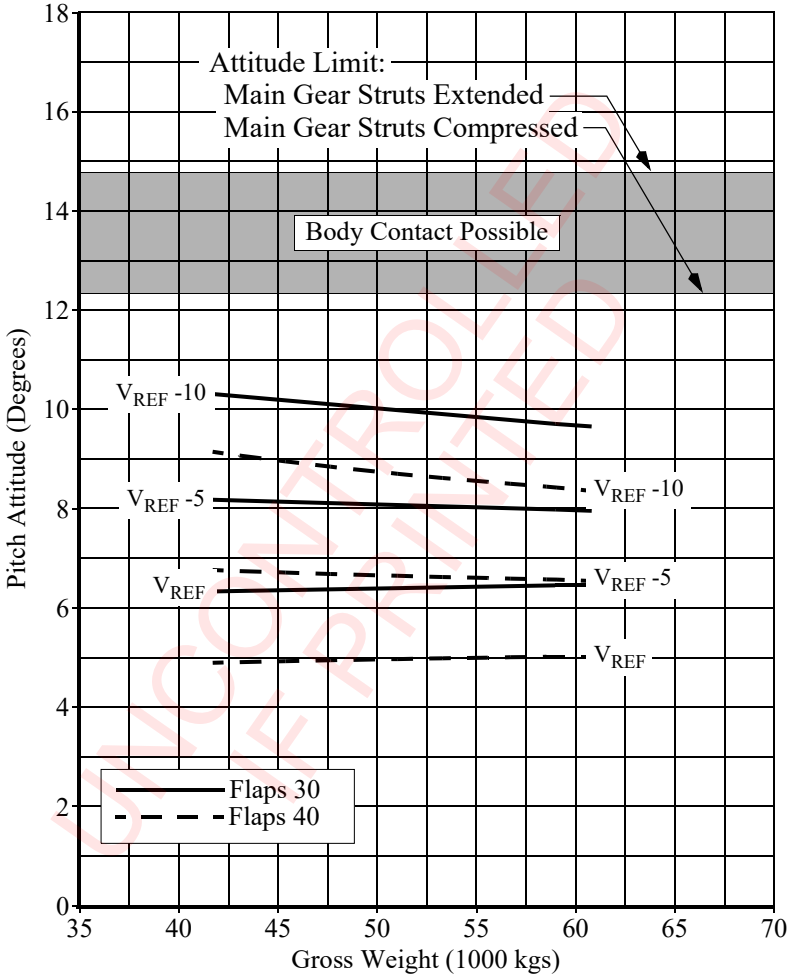

737 NG Flight Crew Training Manual

Touchdown Body Attitudes - Kilograms

737-800

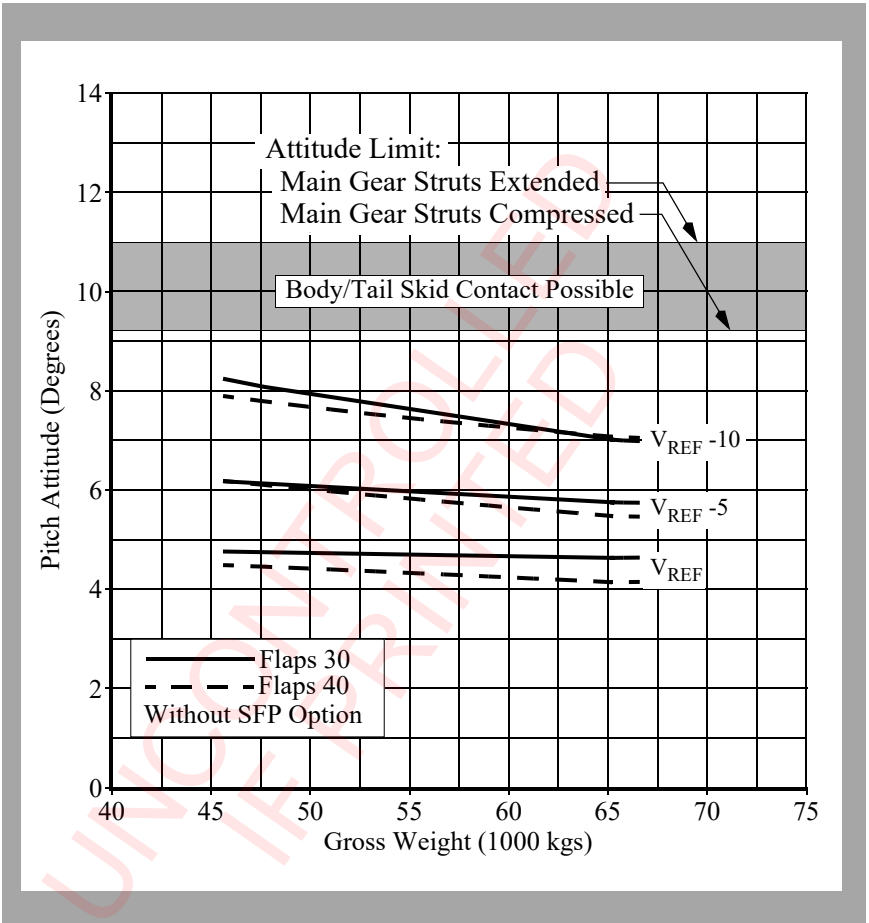

Touchdown Body Attitudes - Kilograms

737-800

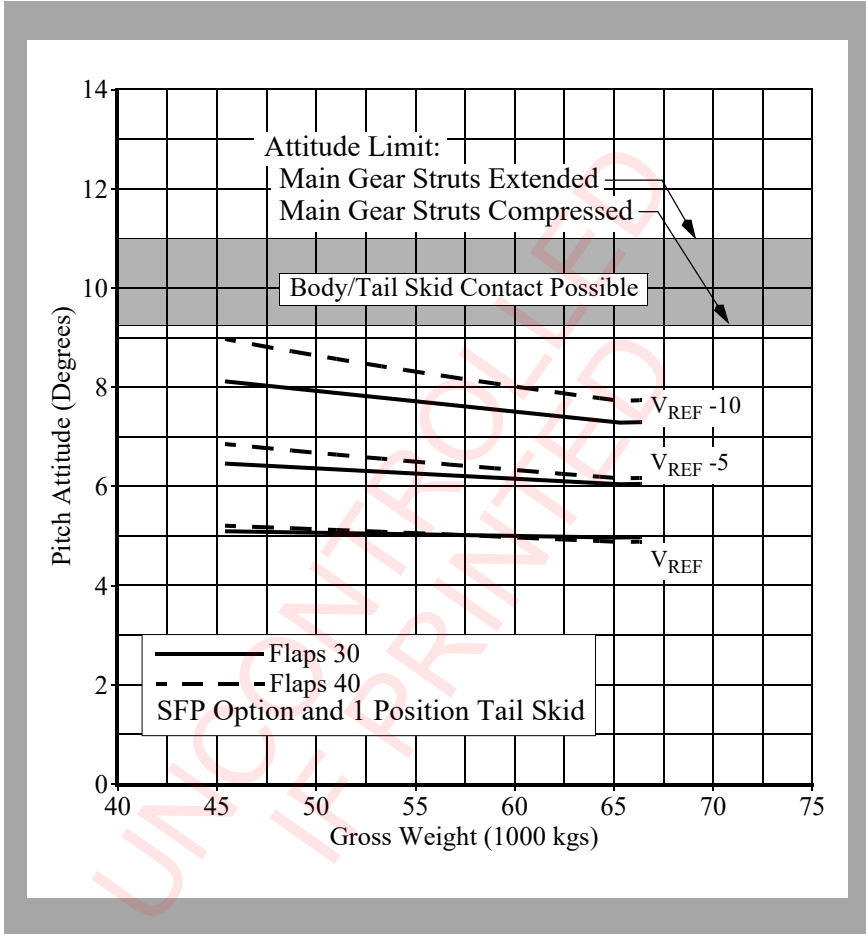

737 NG Flight Crew Training Manual

Touchdown Body Attitudes - Kilograms

737-800

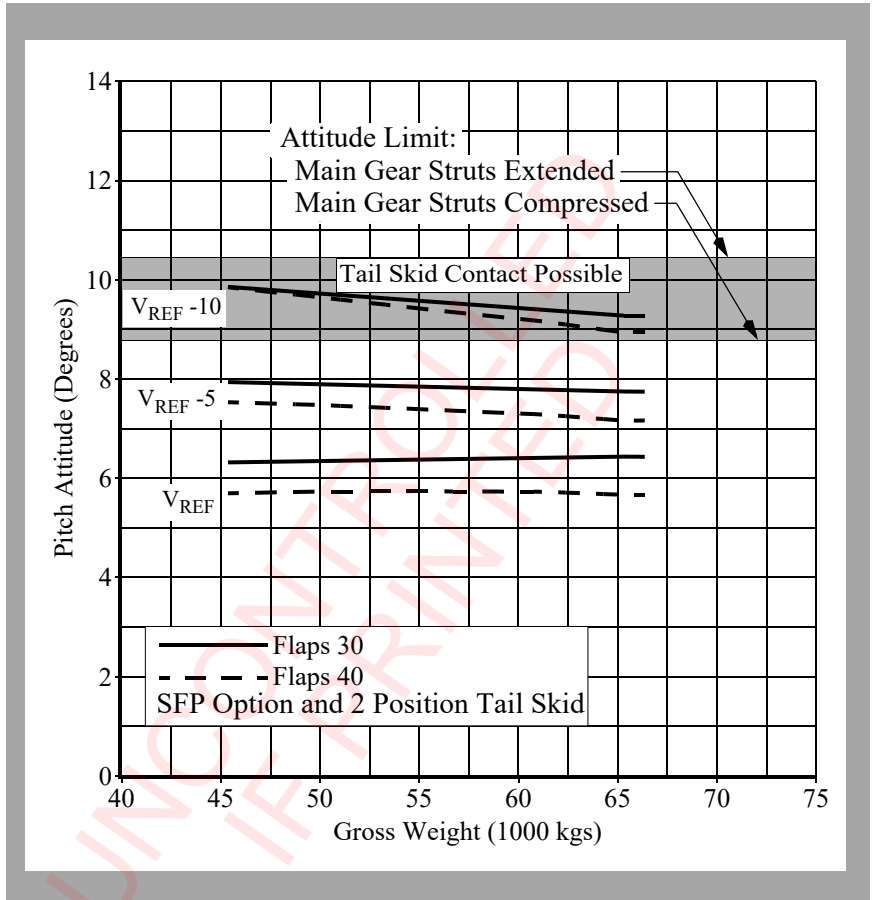

Touchdown Body Attitudes - Kilograms

737-900

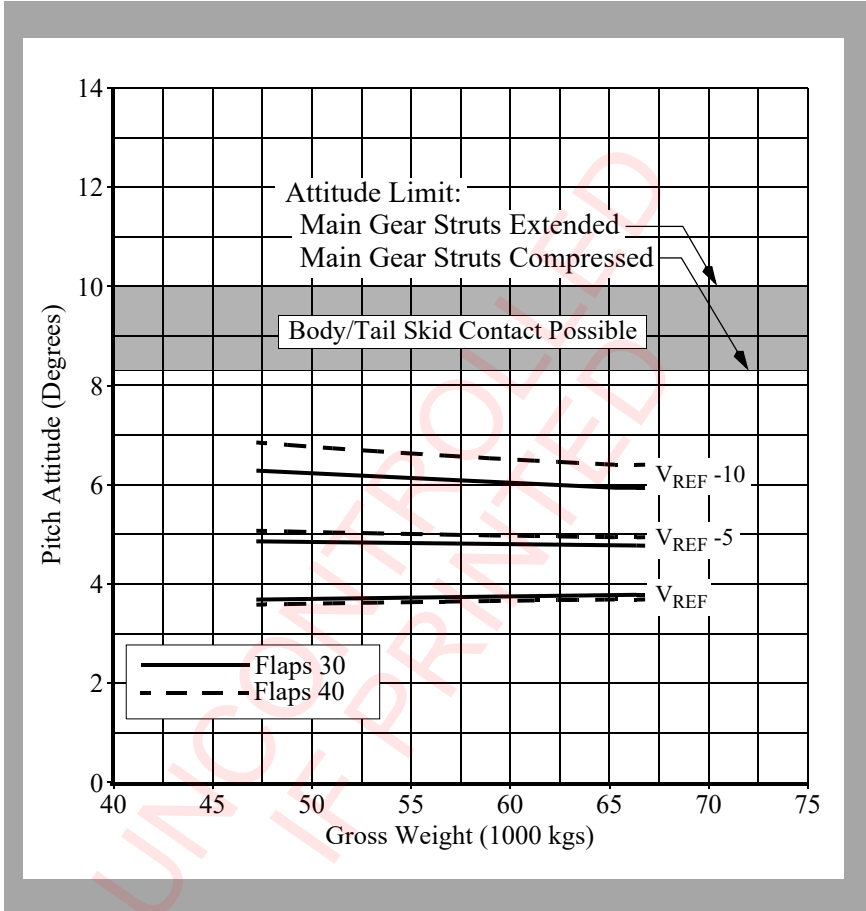

737 NG Flight Crew Training Manual

Touchdown Body Attitudes - Kilograms

737-900ER

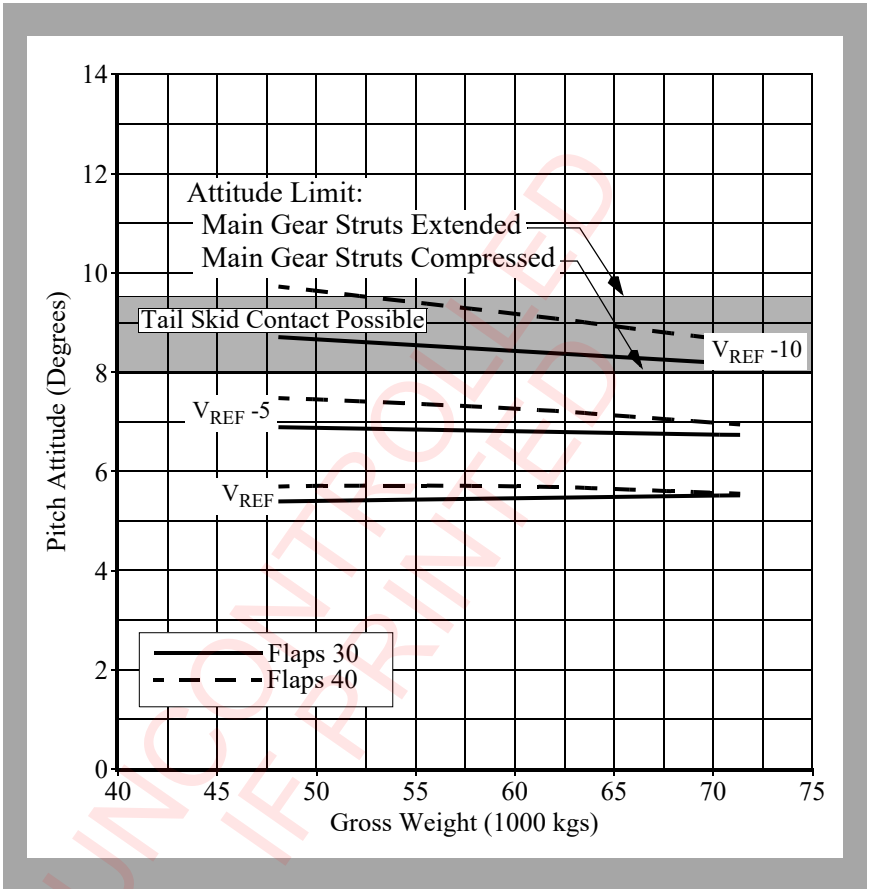

Touchdown Body Attitudes - Pounds

737-600

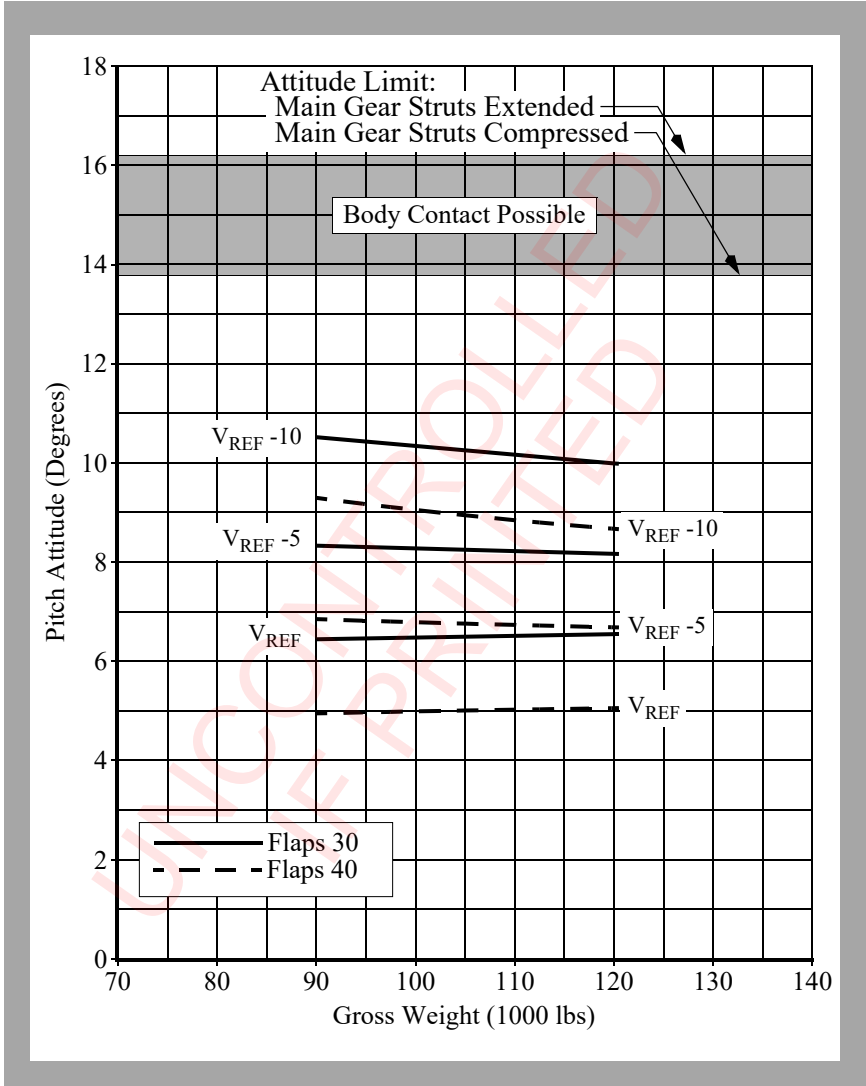

737 NG Flight Crew Training Manual

Touchdown Body Attitudes - Pounds

737-700

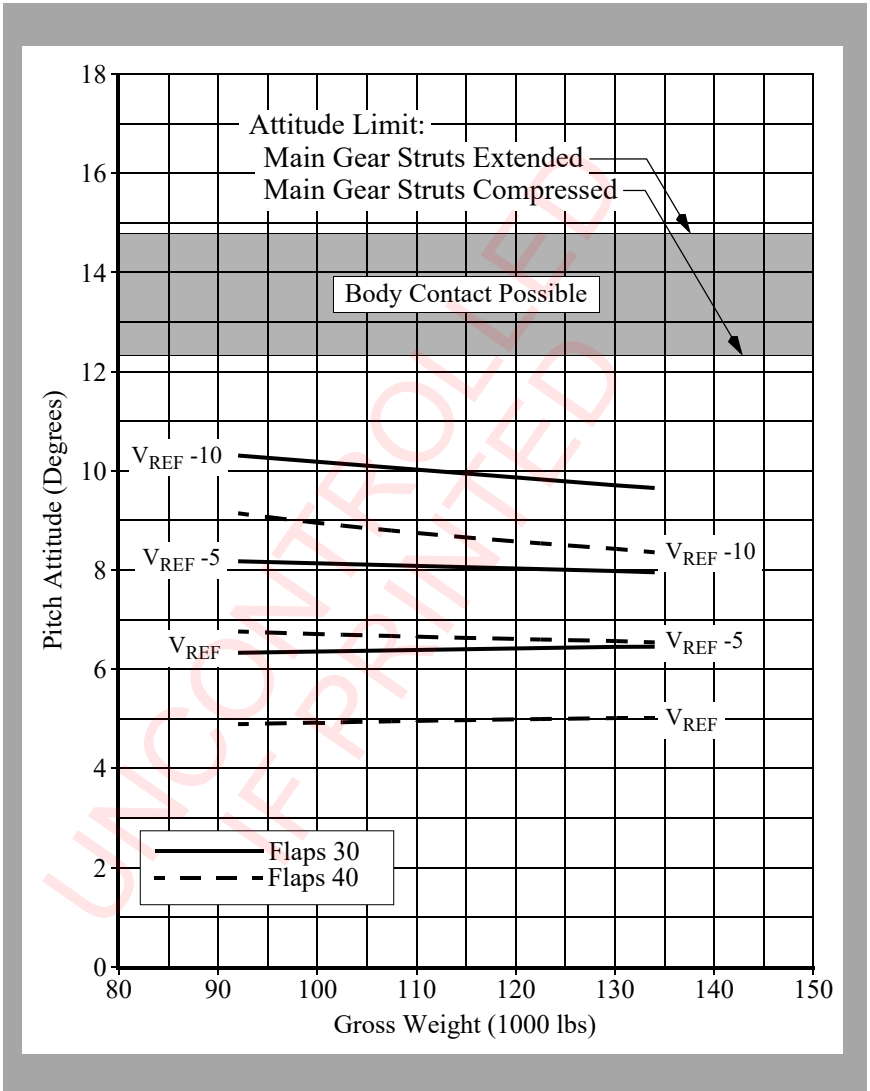

Touchdown Body Attitudes - Pounds

737-800

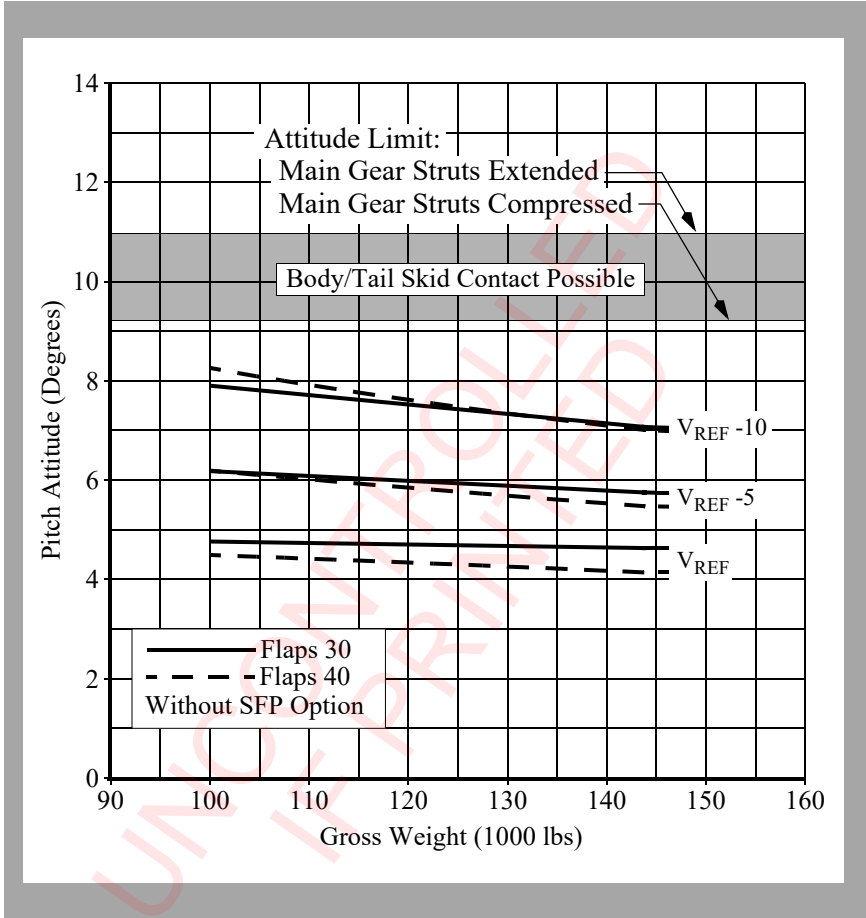

737 NG Flight Crew Training Manual

Touchdown Body Attitudes - Pounds

737-800

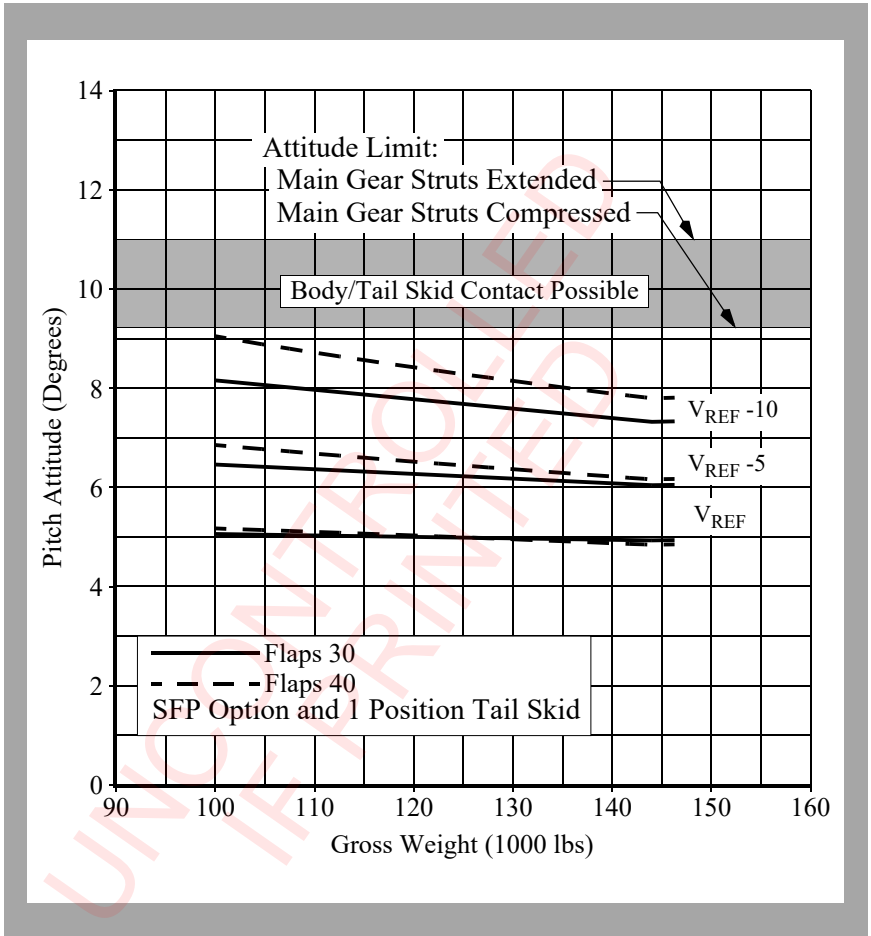

Touchdown Body Attitudes - Pounds

737-800

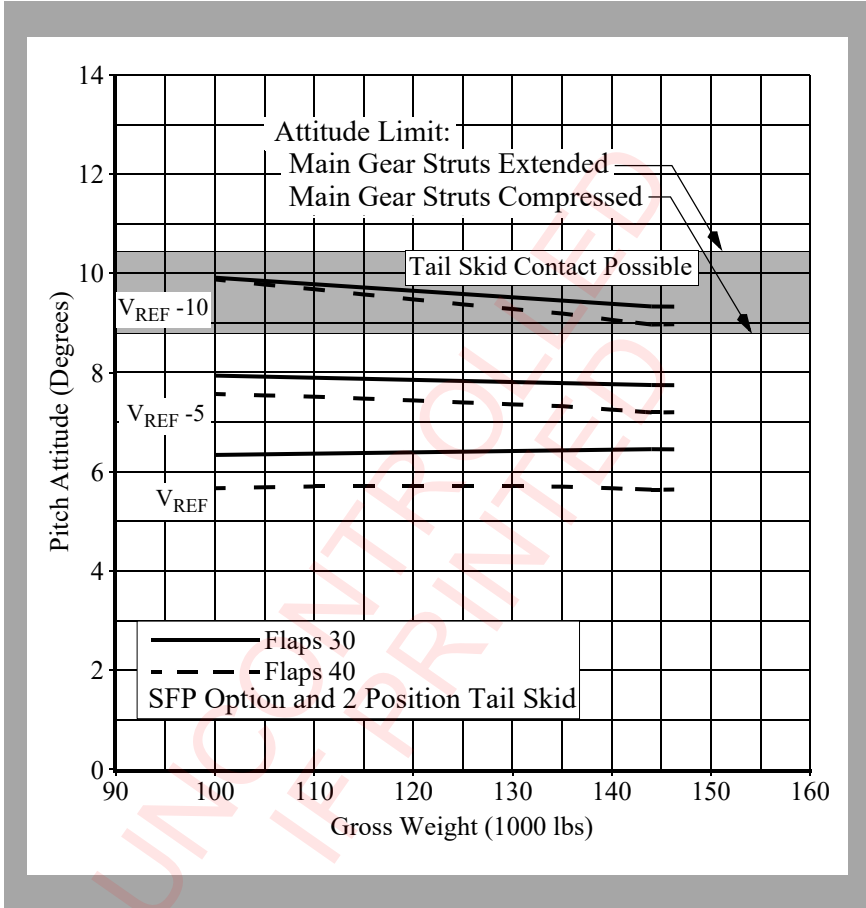

737 NG Flight Crew Training Manual

Touchdown Body Attitudes - Pounds

737-900

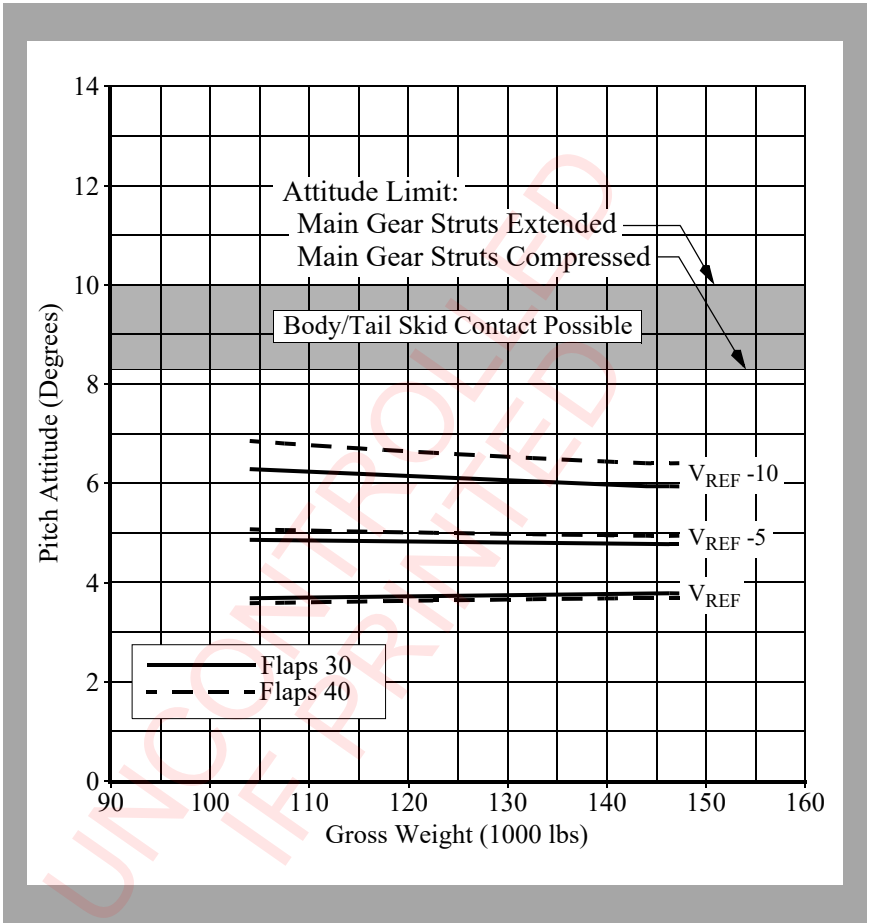

Touchdown Body Attitudes - Pounds

737-900ER

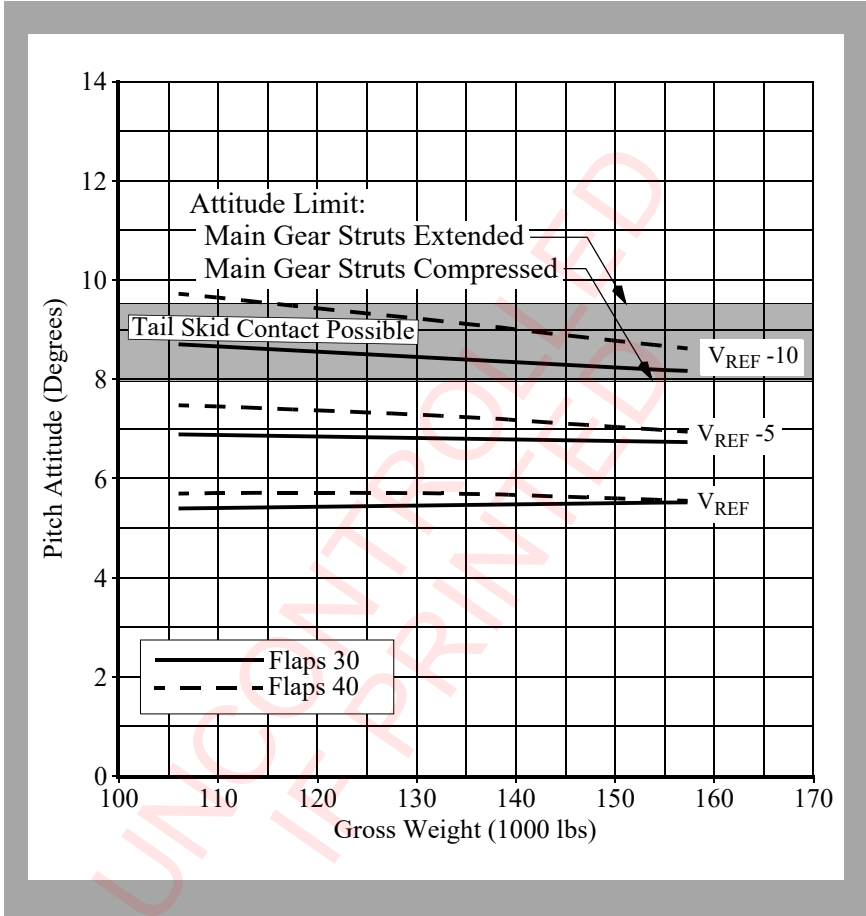

737 NG Flight Crew Training Manual

Pitch and Roll Limit Conditions

The Ground Contact Angles - Normal Landing figures illustrate body roll/pitch angles at which the airplane structure contacts the runway.

Note: The figures are based on a rigid wing, however, dynamic maneuvering can reduce this envelope due to structural flexing of the airframe. Therefore, body roll/pitch angles within the envelope shown on the figures can result in airplane structure contacting the runway.

Conditions

- Pitch about main gear centerline
- Roll about main gear outside tire
- Static strut compression
- Valid for all flap detents
- Valid for all control surface positions

UNCONTROLLED
IF PRINTED

Ground Contact Angles - Normal Landing

737-600

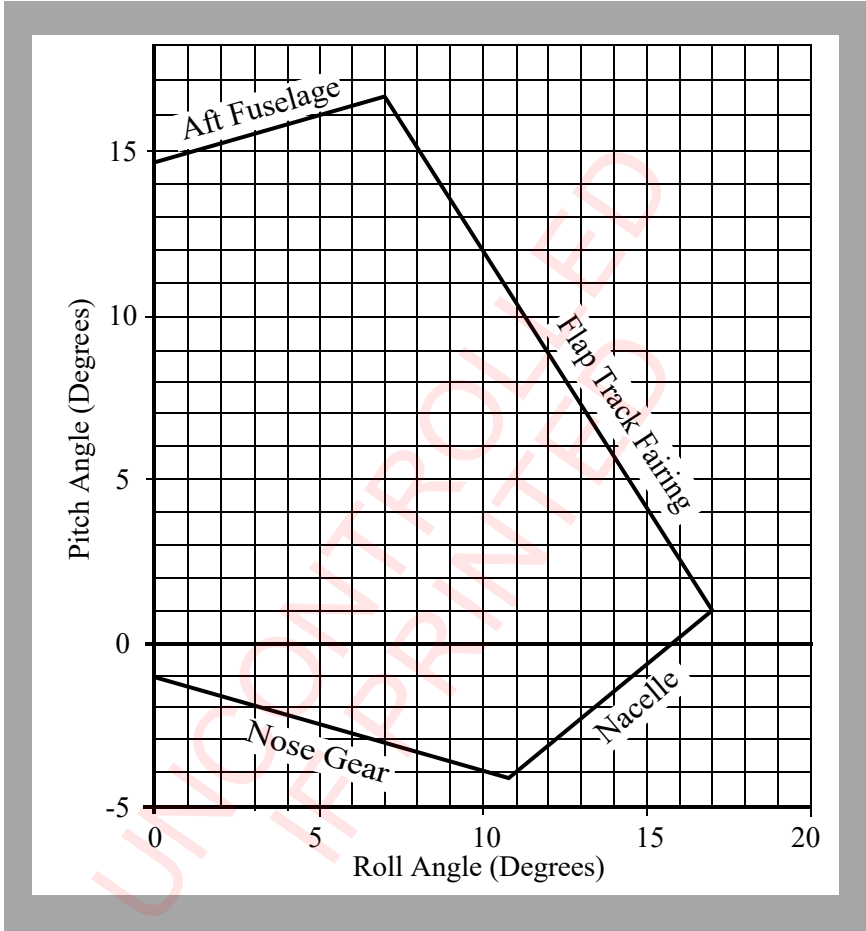

737 NG Flight Crew Training Manual

Ground Contact Angles - Normal Landing

737-700

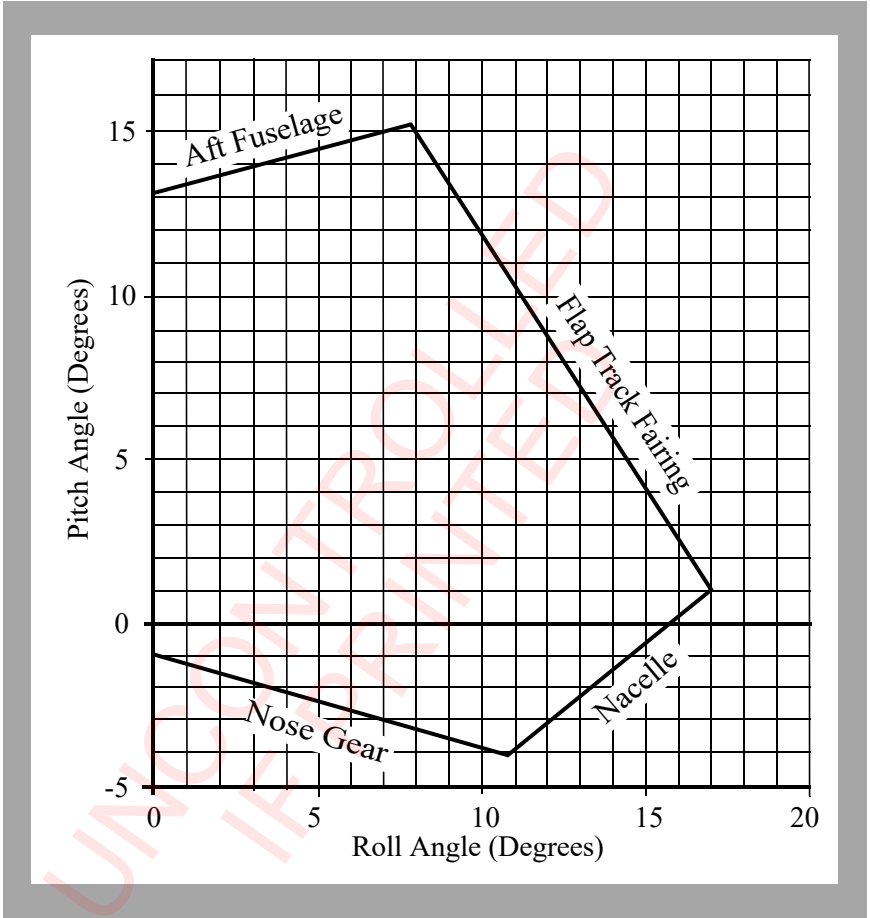

Ground Contact Angles - Normal Landing

737-800

The line labeled “1-Position Tail Skid” is for airplanes without the SFP option and airplanes with the SFP option and a 1 position tail skid.

The line labeled “2-Position Tail Skid Extended” is for airplanes with the SFP option and a 2 position tail skid.

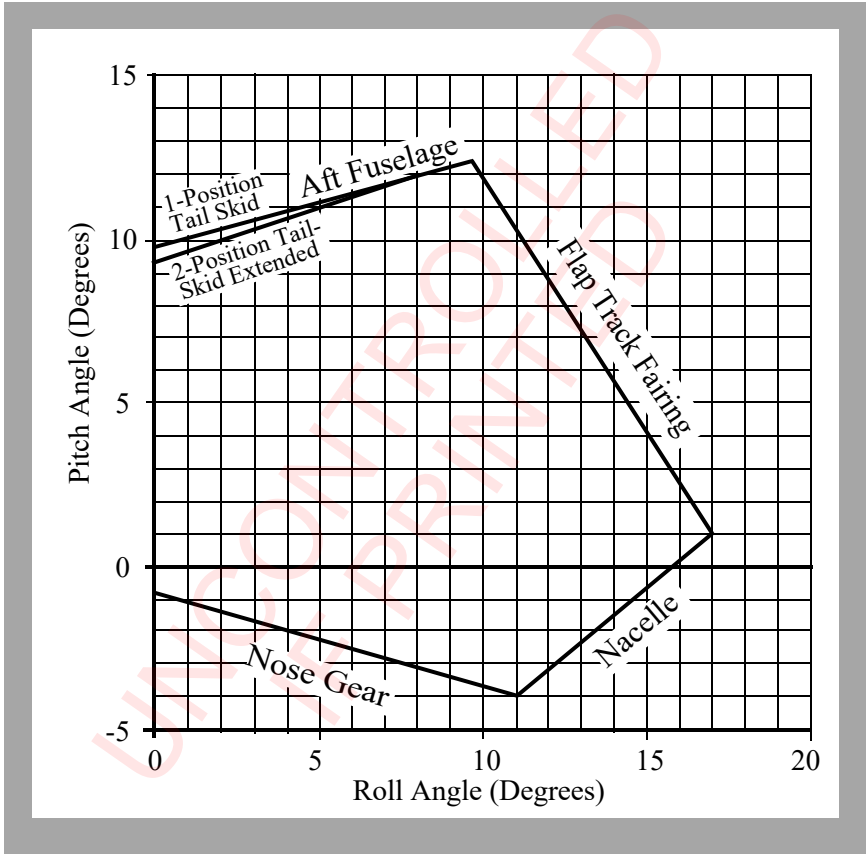

737 NG Flight Crew Training Manual

Ground Contact Angles - Normal Landing

737-900, 737-900ER

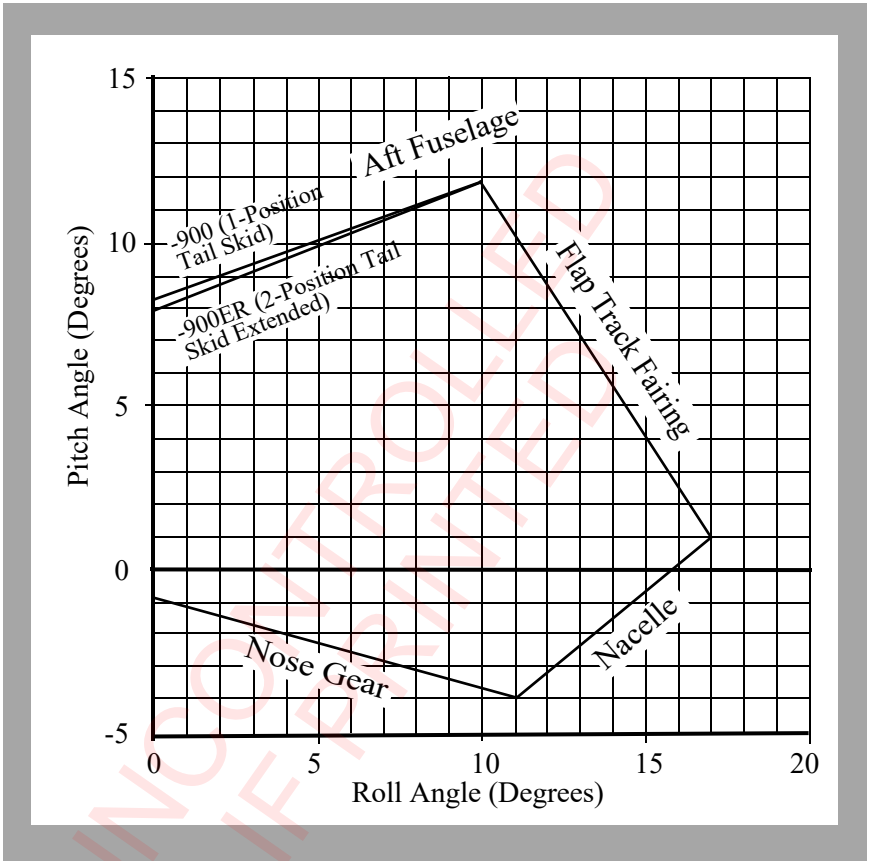

Bounced Landing Recovery

If higher than idle thrust is maintained through initial touchdown, the automatic speedbrake deployment may be disabled even when the speedbrakes are armed. This can result in a bounced landing. During the resultant bounce, if the thrust levers are then retarded to idle, automatic speedbrake deployment can occur. This results in a loss of lift and nose up pitching moment which can result in a tail strike or hard landing on a subsequent touchdown.

If the airplane bounces during a landing attempt, hold or re-establish a normal landing attitude and add thrust as necessary to control the rate of descent. Thrust need not be added for a shallow bounce or skip. If a high, hard bounce occurs, initiate a go-around. Manually advance thrust levers to go-around thrust, and verify speedbrakes are retracted. Do not retract the flaps or landing gear until a positive rate of climb is established because a second touchdown may occur during the go-around. When safely airborne continue with the Go-Around and Missed Approach procedure as prescribed in the FCOM/QRH.

Note: When landing, the TO/GA switches are inhibited near touchdown and on the ground. Refer to the FCOM, Automatic Flight chapter for details.

Rejected Landing / Balked Landing

Rejected Landing

A rejected landing is a discontinued landing attempt and go-around initiated at low altitude (below DA(H) or MDA(H)) but prior to touchdown. If a rejected landing becomes necessary, follow the Go-Around and Missed Approach procedure as prescribed in the FCOM/QRH.

Note: When landing, the TO/GA switches are inhibited near touchdown and on the ground. Refer to the FCOM, Automatic Flight chapter for details.

Balked Landing

A balked landing is a discontinued landing attempt and go-around initiated at or after touchdown, but prior to initiation of reverse thrust. The balked landing technique maintains landing flap configuration to expedite climb away from the runway environment. Considerations for a balked landing include clearance of an obstacle in the runway environment, insufficient runway for continued landing, or transitioning to a go-around from a low-energy state.

Note: When landing, the TO/GA switches are inhibited near touchdown and on the ground. Refer to the FCOM, Automatic Flight chapter for details.

When performing a balked landing, disengage the autopilot, disconnect the autothrottle, smoothly advance thrust levers to go-around thrust, and verify speedbrakes are retracted. Maintain landing flaps configuration and smoothly rotate toward 15° pitch attitude at no less than VREF. Column forces during rotation can vary. When safely airborne with a positive rate of climb, continue the Go-Around and Missed Approach procedure as prescribed in the FCOM/QRH.

WARNING: After reverse thrust is initiated, a full stop landing must be made. If an engine stays in reverse, safe flight is not possible.

Note: The takeoff configuration warning horn sounds when on the ground due to landing flap configuration.

737 NG Flight Crew Training Manual

Selecting the go-around flaps during a bailed landing can cause a decrease in the airplane lift and can result in increased takeoff distance. However, if there is sufficient runway remaining to safely complete the bailed landing with the go-around flap setting, the go-around flap setting can be selected.

For bounced landings, see Bounced Landing Recovery discussion this chapter.

UNCONTROLLED
IF PRINTED

Hard Landing

Appendix A.2.10

Boeing airplanes are designed to withstand touchdown rates well above typical touchdown rates seen during daily operations. Even a perceived hard landing is usually well below these design criteria. Boeing policy is that a pilot report is the only factor that consistently identifies a hard landing. If the pilot believes that a hard landing may have occurred, it should be reported. A maintenance inspection will determine if further maintenance action is needed.

Note: When reporting hard landings, the report should specify if the landing was hard on the nose gear only, hard on the main gear only or hard on both main and nose gear. Specify if the landing was a hard bounced landing.

Note: A bounced landing is defined as a landing where both main gears contact the ground and then both main gears leave the ground prior to landing.

Landing Roll

Avoid touching down with thrust above idle since this may establish an airplane nose up pitch tendency and increase landing roll.

After main gear touchdown, initiate the landing roll procedure. Fly the nose wheels smoothly onto the runway without delay. If the speedbrakes do not extend automatically move the speedbrake lever to the UP position without delay. Control column movement forward of neutral should not be required. Do not attempt to hold the nose wheels off the runway. Holding the nose up after touchdown for aerodynamic braking is not an effective braking technique and results in high nose gear sink rates upon brake application and reduced braking effectiveness.

To avoid possible airplane structural damage, do not make large nose down control column movements before the nose wheels are lowered to the runway.

To avoid the risk of a tail strike, do not allow the pitch attitude to increase after touchdown. However, applying excessive nose down elevator during landing can result in substantial forward fuselage damage. Do not use full down elevator. Use an appropriate autobrake setting or manually apply wheel brakes smoothly with steadily increasing pedal pressure as required for runway condition and runway length available. Maintain deceleration rate with constant or increasing brake pressure as required until stopped or desired taxi speed is reached.

Speedbrakes

The speedbrakes spoil the lift from the wings, which places the airplane weight on the main landing gear, providing excellent brake effectiveness. If the speedbrakes are not raised after touchdown, braking effectiveness may be reduced initially as much as 60%, since very little weight is on the wheels and brake application may cause rapid antiskid modulation.

737 NG Flight Crew Training Manual

The speedbrakes can be fully raised after touchdown while the nose wheels are lowered to the runway with no adverse pitch affects. Normally, speedbrakes are armed to extend automatically. Both pilots should monitor automatic speedbrake extension after touchdown. In the event auto extension fails, the speedbrakes need to be manually extended. After touchdown, fly the nose wheels smoothly to the runway while slowly raising the speedbrake to the up position.

Pilot awareness of the position of the speedbrake lever during the landing phase is important in the prevention of over-run. The position of the speedbrakes should be announced during the landing phase by the PM. This improves the crew's situational awareness of the position of the speedbrakes during landing and builds good habit patterns which can prevent failure to observe a malfunctioned or disarmed speedbrake system.

Directional Control and Braking during Landing Roll

If the nose wheels are not promptly lowered to the runway, braking and steering capabilities are significantly degraded and no drag benefit is gained. Rudder control is effective to approximately 60 knots. Rudder pedal steering is sufficient for maintaining directional control during the rollout. Do not use the nose wheel steering wheel until reaching taxi speed. In a crosswind, displace the control wheel into the wind to maintain wings level which aids directional control. Perform the landing roll procedure immediately after touchdown. Any delay markedly increases the stopping distance.

Use a combination of rudder, differential braking, and control wheel input to maintain runway centerline during strong crosswinds, gusty wind conditions or other situations. Maintain these control input(s) until reaching taxi speeds.

Stopping distance varies with wind conditions and any deviation from recommended approach speeds.

Factors Affecting Landing Distance

Advisory information for normal and non-normal configuration landing distances is contained in the PI chapter of the QRH. Actual stopping distances for a maximum effort stop are approximately 60% of the dry runway field length requirement. Factors that affect stopping distance include: height and speed over the threshold, glide slope angle, landing flare, lowering the nose to the runway, use of reverse thrust, speedbrakes, wheel brakes and surface conditions of the runway.

Note: Reverse thrust and speedbrake drag are most effective during the high speed portion of the landing. Deploy the speedbrake lever and activate reverse thrust with as little time delay as possible.

Note: Speedbrakes fully deployed, in conjunction with maximum reverse thrust and maximum manual antiskid braking provides the minimum stopping distance.

Floating above the runway before touchdown must be avoided because it uses a large portion of the available runway. The airplane should be landed as near the normal touchdown point as possible. Deceleration rate on the runway is approximately three times greater than in the air.

Height of the airplane over the runway threshold also has a significant effect on total landing distance. For example, on a 3° glide path, passing over the runway threshold at 100 feet altitude rather than 50 feet could increase the total landing distance by approximately 950 feet. This is due to the length of runway used up before the airplane actually touches down.

Glide path angle also affects total landing distance. As the approach path becomes flatter, even while maintaining proper height over the end of the runway, total landing distance is increased.

UNCONTROLLED
IF PRINTED

737 NG Flight Crew Training Manual

Factors Affecting Landing Distance (Typical)

The following diagrams show typical increases in landing distance due to improper landing techniques compared to the proper (baseline) condition. These data are based on dry runway, sea level, standard day conditions with landing weights up to the maximum landing weight. Data exclude wet or contamination effects. When increased landing distance is shown as a range, it reflects variations in airplane weight and model variants (if applicable). These calculations are intended for training discussion purposes only.

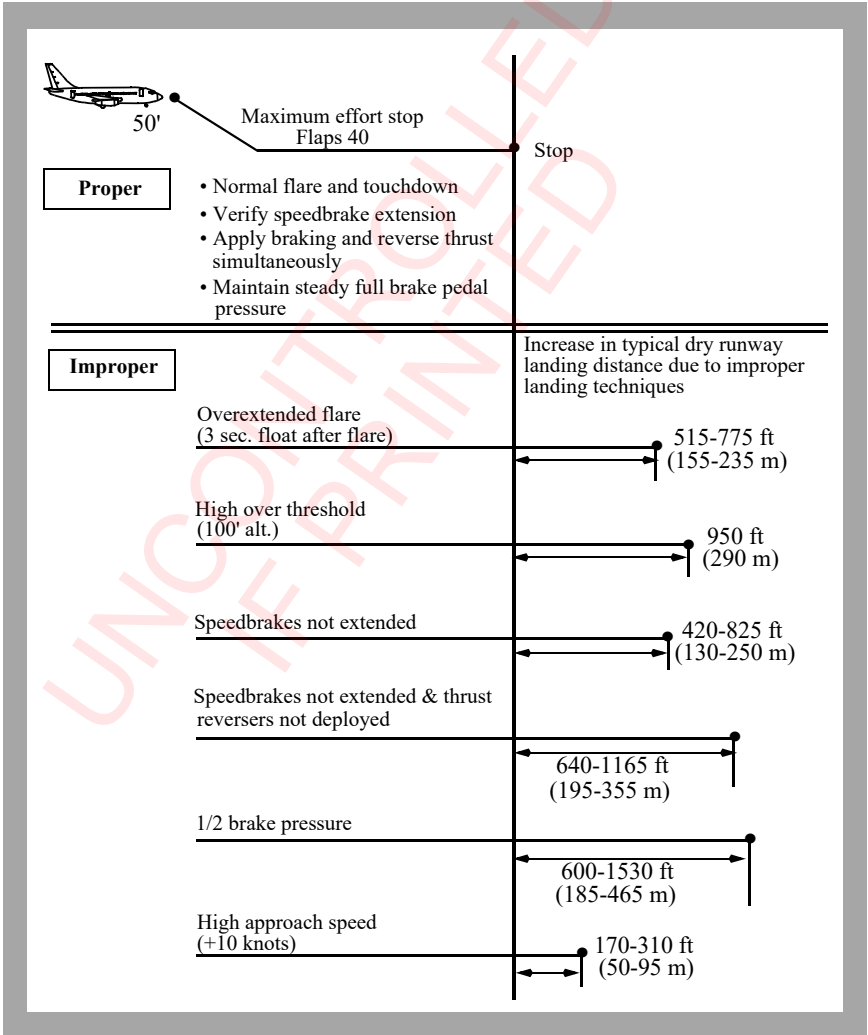

Non-Normal Landing Distance

Because of the higher approach speeds and the possible degraded capability of deceleration devices (spoiler, brakes, reversers) associated with the non-normal landing condition, the actual landing distance is increased. The Non-Normal Configuration Landing Distance table in the PI chapter of the QRH shows VREF and landing distances for various non-normal landing configurations and runway conditions.

Slippery Runway Landing Performance

Appendix A.2.11

When landing on slippery runways contaminated with ice, snow, slush or standing water, the reported braking action must be considered. Advisory information for reported braking actions of good, medium and poor is contained in the PI chapter of the QRH. Also provided in the QRH are stopping distances for the various autobrake settings and for non-normal configurations. Pilots should use extreme caution to ensure adequate runway length is available when poor braking action is reported.

Pilots should keep in mind slippery/contaminated runway advisory information is based on an assumption of uniform conditions over the entire runway. This means a uniform depth for slush/standing water for a contaminated runway or a fixed braking coefficient for a slippery runway. The data cannot cover all possible slippery/contaminated runway combinations and does not consider factors such as rubber deposits or heavily painted surfaces near the end of most runways.

One of the commonly used runway descriptors is coefficient of friction. Ground friction measuring vehicles typically measure this coefficient of friction. Much work has been done in the aviation industry to correlate the friction reading from these ground friction measuring vehicles to airplane performance. Use of ground friction vehicles raises the following concerns:

- the measured coefficient of friction depends on the type of ground friction measuring vehicle used. There is not a method, accepted worldwide, for correlating the friction measurements from the different friction measuring vehicles to each other, or to the airplane's braking capability.
- most testing to date, which compares ground friction vehicle performance to airplane performance, has been done at relatively low speeds (100 knots or less). The critical part of the airplane's deceleration characteristics is typically at higher speeds (120 to 150 knots).

737 NG Flight Crew Training Manual

- ground friction vehicles often provide unreliable readings when measurements are taken with standing water, slush or snow on the runway. Ground friction vehicles might not hydroplane (aquaplane) when taking a measurement while the airplane may hydroplane (aquaplane). In this case, the ground friction vehicles would provide an optimistic reading of the runway's friction capability. The other possibility is the ground friction vehicles might hydroplane (aquaplane) when the airplane would not, this would provide an overly pessimistic reading of the runway's friction capability. Accordingly, friction readings from the ground friction vehicles may not be representative of the airplane's capability in hydroplaning conditions.
- ground friction vehicles measure the friction of the runway at a specific time and location. The actual runway coefficient of friction may change with changing atmospheric conditions such as temperature variations, precipitation etc. Also, the runway condition changes as more operations are performed.

The friction readings from ground friction measuring vehicles do supply an additional piece of information for the pilot to evaluate when considering runway conditions for landing. Crews should evaluate these readings in conjunction with the PIREPS (pilot reports) and the physical description of the runway (snow, slush, ice etc.) when planning the landing. Special care should be taken in evaluating all the information available when braking action is reported as poor or if slush/standing water is present on the runway.

Wheel Brakes

Braking force is proportional to the force of the tires on the runway and the coefficient of friction between the tires and the runway. The contact area normally changes little during the braking cycle. The perpendicular force comes from airplane weight and any downward aerodynamic force such as speedbrakes.

The coefficient of friction depends on the tire condition and runway surface, (e.g. concrete, asphalt, dry, wet or icy).

Automatic Brakes

Use of the autobrake system is recommended whenever the runway is limited, when using higher than normal approach speeds, landing on slippery runways, or landing in a crosswind.

For normal operation of the autobrake system select a deceleration setting.

Settings include:

- **MAX:** Used when minimum stopping distance is required. Deceleration rate is less than that produced by full manual braking
- **3:** Should be used for wet or slippery runways or when landing rollout distance is limited. If adequate rollout distance is available, autobrake setting 2 may be appropriate
- **1 or 2:** These settings provide a moderate deceleration suitable for all routine operations.

Experience with various runway conditions and the related airplane handling characteristics provide initial guidance for the level of deceleration to be selected.

Immediate initiation of reverse thrust at main gear touchdown and full reverse thrust allow the autobrake system to reduce brake pressure to the minimum level. Since the autobrake system senses deceleration and modulates brake pressure accordingly, the proper application of reverse thrust results in reduced braking for a large portion of the landing roll.

The importance of establishing the desired reverse thrust level as soon as possible after touchdown cannot be overemphasized. This minimizes brake temperatures and tire and brake wear and reduces stopping distance on very slippery runways.

The use of minimum reverse thrust as compared to maximum reverse thrust can double the brake energy requirements and result in brake temperatures much higher than normal.

After touchdown, crewmembers should be alert for autobrake disengagement annunciations. The PM should notify the PF anytime the autobrakes disengage.

If stopping distance is not assured with autobrakes engaged, the PF should immediately apply manual braking sufficient to assure deceleration to a safe taxi speed within the remaining runway.

737 NG Flight Crew Training Manual

A table in the PI chapter of the QRH shows the stopping capabilities of the available autobrake selections.

Transition to Manual Braking

The speed at which the transition from autobrakes to manual braking is made depends on airplane deceleration rate, runway conditions and stopping requirements. Normally the speedbrakes remain deployed until taxi speed, but may be stowed earlier if stopping distance within the remaining runway is assured. When transitioning to manual braking, use reverse thrust as required until taxi speed. The use of speedbrakes and reverse thrust is especially important when nearing the end of the runway where rubber deposits affect stopping ability.

When transitioning from the autobrake system to manual braking, the PF should notify the PM. Techniques for release of autobrakes can affect passenger comfort and stopping distance. These techniques are:

- stow the speedbrake handle. When stopping distance within the remaining runway is assured, this method provides a smooth transition to manual braking, is effective before or after thrust reversers are stowed, and is less dependent on manual braking technique
- smoothly apply brake pedal force as in a normal stop, until the autobrake system disarms. Following disarming of the autobrakes, smoothly release brake pedal pressure. Disarming the autobrakes before coming out of reverse thrust provides a smooth transition to manual braking
- manually position the autobrake selector off (normally done by the PM at the direction of the PF).

Manual Braking

The following technique for manual braking provides optimum braking for all runway conditions:

The pilot's seat and rudder pedals should be adjusted so that it is possible to apply maximum braking with full rudder deflection.

Immediately after main gear touchdown, smoothly apply a constant brake pedal pressure for the desired braking. For short or slippery runways, use full brake pedal pressure.

- do not attempt to modulate, pump or improve the braking by any other special techniques
- do not release the brake pedal pressure until the airplane speed has been reduced to a safe taxi speed
- the antiskid system stops the airplane for all runway conditions in a shorter distance than is possible with either antiskid off or brake pedal modulation.

The antiskid system adapts pilot applied brake pressure to runway conditions by sensing an impending skid condition and adjusting the brake pressure to each individual wheel for maximum braking. When brakes are applied on a slippery runway, several skid cycles occur before the antiskid system establishes the right amount of brake pressure for the most effective braking.

If the pilot modulates the brake pedals, the antiskid system is forced to readjust the brake pressure to establish optimum braking. During this readjustment time, braking efficiency is lost.

Low available braking coefficient of friction on extremely slippery runways at high speeds may be interpreted as a total antiskid failure. Pumping the brakes degrades braking effectiveness. Maintain steadily increasing brake pressure, allowing the antiskid system to function at its optimum capability.

Although immediate braking is desired, manual braking techniques normally involve a four to five second delay between main gear touchdown and brake pedal application even when actual conditions reflect the need for a more rapid initiation of braking. This delayed braking can result in the loss of 800 to 1,000 feet of runway, as compared to the calculated PI-QRH landing distance which allows for a two second delay. Directional control requirements for crosswind conditions and low visibility may further increase the delays. Distractions arising from a malfunctioning reverser system can also result in delayed manual braking application.

Braking with Antiskid Inoperative

When the antiskid system is inoperative, the NNC provides the following guidance:

- ensure that the nose wheels are on the ground and the speedbrakes are extended before applying the brakes
- initiate wheel braking using very light pedal pressure and increase pressure as ground speed decreases
- apply steady pressure.
- use minimum braking consistent with runway length and conditions to reduce the possibility of tire blowout
- do not pump the brakes - each time the brakes are released, the required stopping distance is increased. Also, each time the brakes are reapplied, the probability of a skid is increased.

Flight testing has demonstrated that braking effectiveness on a wet grooved runway is similar to that of a dry runway. However caution must be exercised when braking on any wet, ungrooved portions of the runway with antiskid inoperative to avoid tire failure.

737 NG Flight Crew Training Manual

Carbon Brake Life

For carbon brakes (as installed), brake wear is primarily dependent upon the number of brake applications. For example, one firm brake application causes less wear than several light applications. Continuous light applications of the brakes to keep the airplane from accelerating over a long period of time (riding the brakes) to maintain a constant taxi speed produces more wear than proper brake application.

For normal landing conditions, autobrakes 2 or 3 optimizes brake wear, passenger comfort, and stopping performance. Autobrakes 2 or 3 results in higher brake surface temperature and shorter stopping distances, which can increase carbon brake life.

During landing, one hard, high energy, long-duration brake application produces the same amount of wear as a light, low-energy, short application. This is different from steel brakes that wear as a function of the energy input during the stop.

During taxi, proper braking involves a steady application of the brakes to decelerate the airplane. Release the brakes as lower speed is achieved. After the airplane accelerates, repeat the braking sequence.

Brake Cooling

A series of taxi-back or stop and go landings without additional in-flight brake cooling can cause excessive brake temperatures. The energy absorbed by the brakes from each landing is cumulative.

Extending the gear a few minutes early in the approach normally provides sufficient cooling for a landing. Total in-flight cooling time can be determined from the PI chapter of the QRH.

The optional brake temperature monitoring system may be used for additional flight crew guidance in assessing brake energy absorption. This system indicates a stabilized value approximately fifteen minutes after brake energy absorption. Therefore, an immediate or reliable indication of tire or hydraulic fluid fire, wheel bearing problems, or wheel fracture is not available. The brake temperature monitor readings may vary between brakes during normal braking operations.

Note: Brake energy data provided in the QRH should be used to identify potential overheat situations.

Close adherence to recommended landing roll procedures ensures minimum brake temperature build up.

Minimum Brake Heating

Consider using the following technique if landing overweight or other factors exist that may lead to excessive brake temperatures. A normal landing, at weights up to maximum landing weight, does not require special landing techniques.

Note: Autolands are not recommended for overweight landings.

To minimize brake temperature build-up, use the following landing techniques:

- select the longest runway available, but avoid landing downwind
- use the largest available landing flap setting
- use an autobrake setting, consistent with reported runway conditions, that will result in the use of all available runway length. A stopping distance safety margin should be used in accordance with airline policy. Although the autobrakes initially increase brake temperature, the brake contribution is minimized after reverser deployment
- ensure all of the headwind additive is bled off before touchdown to avoid landing with excessive airspeed
- use a normal gear touchdown aim point
- do not allow the airplane to float
- ensure the spoilers deploy immediately after touchdown
- select maximum reverse thrust as soon as possible after main gear touchdown. Do not wait for nose wheel touchdown. The intention is to use reverse thrust as the major force that stops the airplane. The use of maximum reverse thrust further minimizes brake heating
- as soon as stopping is assured in the remaining runway, turn the autobrakes off and continue slowing the airplane with reverse thrust
- if stopping in the remaining runway is in doubt, continue use of autobrakes or take over manually and apply up to maximum braking as needed
- consider extending the landing gear early to provide maximum brake cooling as needed.

Reverse Thrust Operation

Awareness of the position of the forward and reverse thrust levers must be maintained during the landing phase. Improper seat position as well as long sleeved apparel may cause inadvertent advancement of the forward thrust levers, preventing movement of the reverse thrust levers.

The position of the hand should be comfortable, permit easy access to the autothrottle disconnect switch, and allow control of all thrust levers, forward and reverse, through full range of motion.

Note: Reverse thrust is most effective at high speeds.

737 NG Flight Crew Training Manual

After touchdown, with the thrust levers at idle, rapidly raise the reverse thrust levers up and aft to the interlock position, then to the number 2 reverse thrust detent. Conditions permitting, limit reverse thrust to the number 2 detent. The PM should monitor engine operating limits and call out any engine operational limits being approached or exceeded, any thrust reverser failure, or any other abnormalities.

Maintain reverse thrust as required, up to maximum, until stopping on the remaining runway is assured.

When stopping is assured and the airspeed approaches 60 KIAS start reducing the reverse thrust so that the reverse thrust levers are moving down at a rate commensurate with the deceleration rate of the airplane. The reverse thrust levers should be positioned to reverse idle by taxi speed, then to full down after the engines have decelerated to idle. Reverse thrust is reduced to idle between 60 KIAS and taxi speed to prevent engine exhaust re-ingestion and to reduce the risk of FOD. It also helps the pilot maintain directional control in the event a reverser becomes inoperative.

Note: If an engine surges during reverse thrust operation, quickly select reverse idle on both engines.

The PM should call out 60 knots to assist the PF in scheduling the reverse thrust. The PM should also call out any inadvertent selection of forward thrust as reverse thrust is canceled.

UNCONTROLLED
IF PRINTED

Reverse Thrust Operations

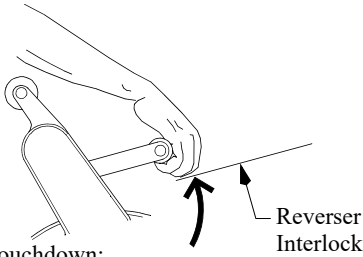

At Touchdown:
Up and aft rapidly to interlock.
Maintain light pressure on interlock.

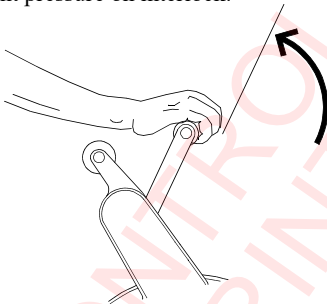
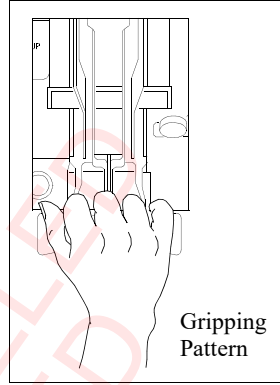

After reverser interlock release:
Apply reverse thrust as needed until 60 KIAS.

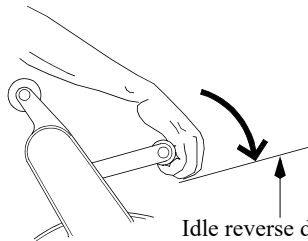

Approaching 60 KIAS:
Decrease to idle reverse before taxi speed.

Reverse Thrust and Crosswind (All Engines)

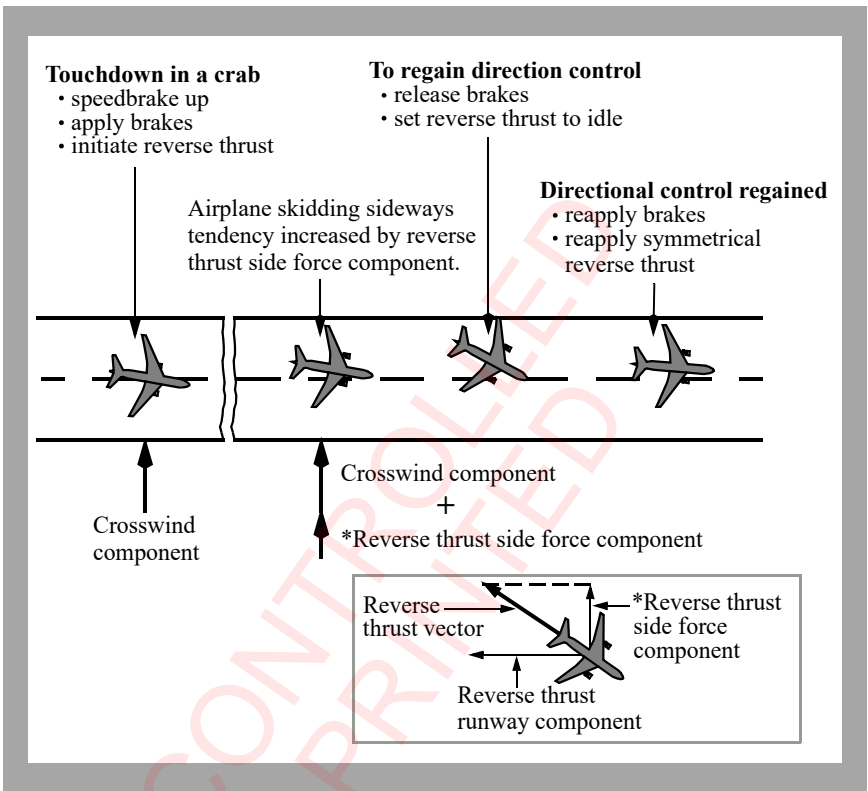

This figure shows a directional control problem during a landing rollout on a slippery runway with a crosswind. As the airplane starts to weathervane into the wind, the reverse thrust side force component adds to the crosswind component and drifts the airplane to the downwind side of the runway. Also, high braking forces reduce the capability of the tires to corner.

To correct back to the centerline, release the brakes and reduce reverse thrust to reverse idle. Releasing the brakes increases the tire-cornering capability and contributes to maintaining or regaining directional control. Setting reverse idle reduces the reverse thrust side force component without the requirement to go through a full reverser actuation cycle. Use rudder pedal steering and differential braking as required, to prevent over correcting past the runway centerline. When directional control is regained and the airplane is correcting toward the runway centerline, apply maximum braking and symmetrical reverse thrust to stop the airplane.

Note: Use of this technique increases the required landing distance.

Reverse Thrust - EEC in the Alternate Mode

Use normal reverse thrust techniques.

Reverse Thrust - Engine Inoperative

Asymmetrical reverse thrust may be used with one engine inoperative. Use normal reverse thrust procedures and techniques. One thrust lever (operating engine) or both thrust levers may be brought to the reverse idle position. If directional control becomes a problem during deceleration, return the thrust lever to the reverse idle detent.

Crosswind Landings

The crosswind guidelines shown below were derived through flight test data, engineering analysis and flight simulator evaluations. These crosswind guidelines are based on steady wind (no gust) conditions and include all engines operating and engine inoperative. Gust effects were evaluated and tend to increase pilot workload without significantly affecting the recommended guidelines. The crosswind guidelines presented in the table below should be considered the maximum recommended crosswinds, including gusts, unless an operator has provided different crosswind and gust guidance.

Landing Crosswind Guidelines

Appendix A.2.11

Crosswind guidelines are not considered limitations. Crosswind guidelines are provided to assist operators in establishing their own crosswind policies.

On slippery runways, crosswind guidelines are a function of runway surface condition. These guidelines assume adverse airplane loading and proper pilot technique.

Landing Crosswind Guidelines - Non-TALPA

Runway Condition	Crosswind Component (knots) *
Dry	40 ***
Wet	40 ***
Standing Water/Slush	20 ***
Snow - No Melting **	35 ***
Ice - No Melting **	17

737 NG Flight Crew Training Manual
Runway Condition Assessment - TALPA

The following table is an abbreviated version of the Matrix for runway condition assessment in terms of Takeoff and Landing Performance Assessment Aviation Rules Committee (TALPA) categories and contained in AC 25-32. The runway condition descriptions and codes are aligned with control/braking action reports.

Runway Condition Assessment		
Runway Condition Description	Runway Condition Code	Control / Braking Action
<ul style="list-style-type: none"> • Dry 	6	---
<ul style="list-style-type: none"> • Frost • Wet (includes damp and 1/8" (3mm) depth or less of water) <li style="padding-left: 40px;">1/8" (3mm) depth or less: • Slush • Dry Snow • Wet Snow 	5	Good
<p style="text-align: center;">-15°C and colder OAT:</p> <ul style="list-style-type: none"> • Compacted Snow 	4	Good to Medium
<ul style="list-style-type: none"> • Slippery when wet (wet runway) • Dry or Wet Snow (any depth) over Compacted Snow <li style="padding-left: 40px;">Greater than 1/8" (3mm) depth: • Dry Snow • Wet Snow <li style="padding-left: 40px;">Warmer than -15°C OAT: • Compacted snow 	3	Medium
<p style="text-align: center;">Greater than 1/8" (3mm) depth:</p> <ul style="list-style-type: none"> • Water • Slush 	2	Medium to Poor
<ul style="list-style-type: none"> • Ice 	1	Poor
<ul style="list-style-type: none"> • Wet Ice • Water on top of Compacted Snow • Dry Snow or Wet Snow over Ice 	0	Nil

Landing Crosswind Guidelines - TALPA

The crosswind guideline is determined by entering the table below with Runway Condition Code or Control/Braking Action.

Runway Condition Code	Control / Braking Action	Crosswind Component (knots) *
6	---	40 ***
5**	Good	40 ***
4**	Good to Medium	35 ***
3**	Medium	25 ***
2**	Medium to Poor	17
1**	Poor	15
0**	Nil	---

Note: Reduce crosswind guidelines by 5 knots on wet or contaminated runways whenever asymmetric reverse thrust is used.

*Winds measured at 33 feet (10 m) tower height and apply for runways 148 feet (45m) or greater in width.

** Landing on untreated ice or snow should only be attempted when no melting is present.

*** Sideslip only (zero crab) landings are not recommended with crosswind components in excess of 17 knots at flaps 15, 20 knots at flaps 30, or 23 knots at flaps 40. This recommendation ensures adequate ground clearance and is based on maintaining adequate control margin.

Note: Reduce sideslip only (zero crab) landing crosswinds by 2 knots for airplanes with winglets.

Crosswind Landing Techniques

Three methods of performing crosswind landings are presented. They are the de-crab technique (with removal of crab in flare), touchdown in a crab, and the sideslip technique. Whenever a crab is maintained during a crosswind approach, offset the flight deck on the upwind side of centerline so that the main gear touches down in the center of the runway.

737 NG Flight Crew Training Manual

De-Crab During Flare

The objective of this technique is to maintain wings level throughout the approach, flare, and touchdown. On final approach, a crab angle is established with wings level to maintain the desired track. Just prior to touchdown while flaring the airplane, downwind rudder is applied to eliminate the crab and align the airplane with the runway centerline.

As rudder is applied, the upwind wing sweeps forward developing roll. Hold wings level with simultaneous application of aileron control into the wind. The touchdown is made with cross controls and both gear touching down simultaneously. Throughout the touchdown phase upwind aileron application is utilized to keep the wings level.

Touchdown In Crab

The airplane can land using crab only (zero sideslip) up to the landing crosswind guideline speeds. (See the landing crosswind guidelines table, this chapter).

On dry runways, upon touchdown the airplane tracks toward the upwind edge of the runway while de-crabbing to align with the runway. Immediate upwind aileron is needed to ensure the wings remain level while rudder is needed to track the runway centerline. The greater the amount of crab at touchdown, the larger the lateral deviation from the point of touchdown. For this reason, touchdown in a crab only condition is not recommended when landing on a dry runway in strong crosswinds.

On very slippery runways, landing the airplane using crab only reduces drift toward the downwind side at touchdown, permits rapid operation of spoilers and autobrakes because all main gears touchdown simultaneously, and may reduce pilot workload since the airplane does not have to be de-crabbed before touchdown. However, proper rudder and upwind aileron must be applied after touchdown to ensure directional control is maintained.

Sideslip (Wing Low)

The sideslip crosswind technique aligns the airplane with the extended runway centerline so that main gear touchdown occurs on the runway centerline.

The initial phase of the approach to landing is flown using the crab method to correct for drift. Prior to the flare the airplane centerline is aligned on or parallel to the runway centerline. Downwind rudder is used to align the longitudinal axis to the desired track as aileron is used to lower the wing into the wind to prevent drift. A steady sideslip is established with opposite rudder and low wing into the wind to hold the desired course.

Touchdown is accomplished with the upwind wheels touching just before the downwind wheels. Overcontrolling the roll axis must be avoided because overbanking could cause the engine nacelle or outboard wing flap to contact the runway. (See Ground Clearance Angles - Normal Landing charts, this chapter.)

Boeing Proprietary. Copyright © Boeing. May be subject to export restrictions under EAR. See title page for details.

Properly coordinated, this maneuver results in nearly fixed rudder and aileron control positions during the final phase of the approach, touchdown, and beginning of the landing roll. However, since turbulence is often associated with crosswinds, it is often difficult to maintain the cross control coordination through the final phase of the approach to touchdown.

If the crew elects to fly the sideslip to touchdown, it may be necessary to add a crab during strong crosswinds. (See the landing crosswind guidelines table, this chapter). Main gear touchdown is made with the upwind wing low and crab angle applied. As the upwind gear touches first, a slight increase in downwind rudder is applied to align the airplane with the runway centerline. At touchdown, increased application of upwind aileron should be applied to maintain wings level.

Overweight Landing

Overweight landings may be safely accomplished by using normal landing procedures and techniques. There are no adverse handling characteristics associated with overweight landings. Landing distance is normally less than takeoff distance for flaps 30 or 40 landings at all gross weights. However, wet or slippery runway field length requirements should be verified from the landing distance charts in the PI chapter of the QRH. Brake energy limits will not be exceeded for flaps 30 or 40 normal landings at all gross weights.

Note: Use of flaps 30 rather than flaps 40 is recommended to provide increased margin to flap placard speed.

If stopping distance is a concern, reduce the landing weight as much as possible. At the captain's discretion, reduce weight by holding at low altitude with a high drag configuration (gear down) to achieve maximum fuel burn-off.

Analysis has determined that, when landing at high gross weights at speeds associated with non-normal procedures requiring flaps set at 15 or less, maximum effort stops may exceed the brake energy limits. The gross weights where this condition can occur are well above maximum landing weights. For these non-normal landings, maximize use of the available runway for stopping.

Observe flap placard speeds during flap extension and on final approach. In the holding and approach patterns, maneuvers should be flown at the normal maneuver speeds. During flap extension, airspeed can be reduced by as much as 20 knots below normal maneuver speeds before extending to the next flap position. These lower speeds result in larger margins to the flap placards, while still providing normal bank angle maneuver capability, but do not allow for a 15° overshoot margin in all cases.

737 NG Flight Crew Training Manual

Use the longest available runway, and consider wind and slope effects. Where possible avoid landing in tailwinds, on runways with negative slope, or on runways with less than normal braking conditions. Do not carry excess airspeed on final. This is especially important when landing during an engine inoperative or other non-normal condition. At weights above the maximum landing weight, the final approach maximum wind additive may be limited by the flap placards and load relief system.

Fly a normal profile. Ensure that a higher than normal rate of descent does not develop. Do not hold the airplane off waiting for a smooth landing. Fly the airplane onto the runway at the normal touchdown point. If a long landing is likely to occur, go-around. After touchdown, immediately apply maximum reverse thrust using all of the available runway for stopping to minimize brake temperatures. Do not attempt to make an early runway turnoff.

Autobrake stopping distance guidance is contained in the PI chapter of the QRH. If adequate stopping distance is available based upon approach speed, runway conditions, and runway length, the recommended autobrake setting should be used.

Overweight Autolands Policy

Overweight autolands are not recommended. Autopilots on Boeing airplanes are not certified for automatic landings above maximum landing weight. At higher than normal speeds and weights, the performance of these systems may not be satisfactory and has not been thoroughly tested. An automatic approach may be attempted, however the pilot should disengage the autopilot prior to flare height and accomplish a manual landing.

In an emergency, should the pilot determine that an overweight autoland is the safest course of action, the approach and landing should be closely monitored by the pilot and the following factors considered:

- touchdown may be beyond the normal touchdown zone; allow for additional landing distance
- touchdown at higher than normal sink rates may result in exceeding structural limits
- plan for a go-around or manual landing if autoland performance is unsatisfactory; automatic go-arounds can be initiated until just prior to touchdown, and can be continued even if the airplane touches down after initiation of the go-around.



Intentionally
Blank

UNCONTROLLED
IF PRINTED

**Maneuvers****Chapter 7****Table of Contents****Section TOC**

Preface	7.1
Acceleration to and Deceleration from VMO	7.1
Engine Out Familiarization	7.2
Rudder and Lateral Control	7.2
Thrust and Airspeed	7.4
High Altitude Maneuvering, “G” Buffet	7.4
Rapid Descent	7.5
Autopilot Entry and Level Off	7.6
Manual Entry and Level Off	7.7
Landing Gear Extended Descent	7.7
After Level Off	7.7
Expedited Descent for Freighter Airplanes	7.8
Descent	7.8
Approach	7.9
Approach to Stall or Stall	7.11
Approach to Stall or Stall Recovery	7.12
Approach to Stall or Stall Recovery Training	7.13
Steep Turns	7.17
Entry	7.17
During Turn	7.18
Attitude Indicator	7.18
Vertical Speed Indicator	7.18
Altimeter	7.18
Airspeed	7.18
Rollout	7.18



Terrain Avoidance	7.18
Terrain Avoidance - RNAV (RNP) AR Operations	7.19
Traffic Alert and Collision Avoidance System	7.19
Use of TA/RA, TA Only, and Transponder Only Modes	7.19
Traffic Advisory	7.19
Resolution Advisory	7.20
Upset Prevention and Recovery	7.21
Upset Recovery Maneuvers	7.22
Nose High	7.23
Nose Low	7.25
High Bank Angles	7.25
Windshear	7.26
General	7.26
Airplane Performance in Windshear	7.26
Avoidance, Precautions and Recovery	7.27

UNCONTROLLED
IF PRINTED

Preface

This chapter outlines the recommended operating practices and techniques used during maneuvers in both the training and operational environment. The flight profile illustrations represent the Boeing recommended basic configuration during the accomplishment of the flight maneuvers, and provides a basis for standardization and crew coordination.

Maneuvering for events such as Approach to Stall or Stall Recovery, Terrain Avoidance, Traffic Avoidance, Upset Recovery, or Windshear may result in deviation from the ATC clearance. The crew should expeditiously return to the applicable ATC clearance immediately following such maneuvering unless otherwise directed.

Acceleration to and Deceleration from VMO

Acceleration to and deceleration from VMO demonstrates performance capabilities and response to speed, thrust, and configuration changes throughout the medium altitude speed range of the airplane. This maneuver is performed in the full flight simulator and is for demonstration purposes only. It is normally performed at 10,000 to 15,000 feet, simulating slowdown to 250 knots due to speed restrictions.

VMO is a structural limitation and is the maximum operating indicated airspeed. It is a constant airspeed from sea level to the altitude where VMO and MMO coincide. MMO is the structural limitation above this altitude. Sufficient thrust is available to exceed VMO in level flight at lower altitudes. Failure to reduce to cruise thrust in level flight can result in excessive airspeed.

Begin the maneuver at existing cruise speed with the autothrottle connected and the autopilot disengaged. Set command speed to VMO. As speed increases observe:

- nose down trim required to keep airplane in trim and maintain level flight
- handling qualities during acceleration
- autothrottle protection at VMO.

At a stabilized speed just below VMO execute turns at high speed while maintaining altitude. Next, accelerate above VMO by disconnecting the autothrottle and increasing thrust.



737 NG Flight Crew Training Manual

When the overspeed warning occurs reduce thrust levers to idle, set command speed to 250 knots, and decelerate to command speed. Since the airplane is aerodynamically clean, any residual thrust results in a longer deceleration time. As airspeed decreases observe that nose up trim is required to keep airplane in trim and maintain level flight. During deceleration note the time and distance traveled from when the overspeed warning stops until reaching 250 knots.

Once stabilized at 250 knots, set command speed to flaps up maneuver speed and decelerate to command speed, again noting the distance traveled during deceleration. Observe the handling qualities of the airplane during deceleration.

This maneuver may be repeated using speedbrakes to compare deceleration times and distances.

Engine Out Familiarization

The exercises shown in the following table are performed to develop proficiency in handling the airplane with one engine inoperative and gain familiarization with rudder control requirements.

	Condition One	Condition Two
Airspeed	Flaps up maneuver speed	V2
Landing Gear	Up	Down
Flaps	Up	15
Thrust	As Required	MCT
When In Trim - Retard one thrust lever to idle Controls - Apply to maintain heading, wings level Rudder - Apply to center control wheel Airspeed - Maintain with thrust (Condition One) Pitch (Condition Two) Trim - As required to relieve control forces		

One engine out controllability is excellent during takeoff roll and after lift-off. Minimum control speed in the air is below VR and VREF.

Rudder and Lateral Control

This familiarization is performed to develop proficiency in handling the airplane with an engine inoperative. It also helps to gain insight into rudder control requirements.

737 NG Flight Crew Training Manual

Under instrument conditions the instrument scan is centered around the attitude indicator. Roll is usually the first indication of an asymmetric condition. Roll control (ailerons) should be used to hold the wings level or maintain the desired bank angle. Stop the yaw by smoothly applying rudder at the same rate that thrust changes. When the rudder input is correct, very little control wheel displacement is necessary. Refine the rudder input as required and trim the rudder so the control wheel remains approximately level.

When the rudder is trimmed to level the control wheel, the airplane maintains heading. A small amount of bank toward the operating engine may be noticeable on the bank indicator. The slip/skid indicator is displaced slightly toward the operating engine.

If the airplane is trimmed with too much control wheel displacement, full lateral control is not available and spoilers on one wing may be raised, increasing drag.

Make turns at a constant airspeed and hold the rudder displacement constant. Do not attempt to coordinate rudder and lateral control in turns. Rudder pedal inputs produce roll due to yaw and induce the pilot to counter rudder oscillations with opposite control wheel.

The following figure shows correct and incorrect use of the rudder.

If an engine failure occurs with the autopilot engaged, manually position the rudder to approximately center the control wheel and add thrust. Trim the rudder to relieve rudder pedal pressure.

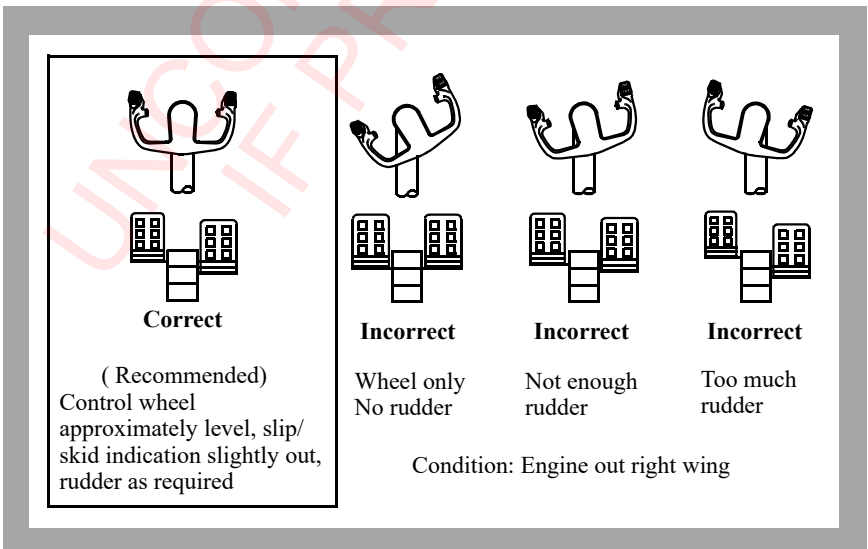

Thrust and Airspeed

If not thrust limited, apply additional thrust, if required, to control the airspeed. The total two engine fuel flow existing at the time of engine failure may be used initially to establish a thrust setting at low altitude. If performance limited (high altitude), adjust airplane attitude to maintain airspeed while setting maximum continuous thrust.

Note: Autothrottle should not be used with an engine inoperative.

High Altitude Maneuvering, “G” Buffet

Airplane buffet reached as a result of airplane maneuvering is commonly referred to as “g” buffet. During turbulent flight conditions, it is possible to experience high altitude “g” buffet at speeds less than MMO. In training, buffet is induced to demonstrate the airplane's response to control inputs during flight in buffet.

Establish an airspeed of 0.80M. Induce “g” buffet by smoothly increasing the bank angle until the buffet is noticeable. Increase the rate of descent while increasing the bank angle to maintain airspeed. Do not exceed 45° of bank. If buffet does not occur by 45° of bank, increase control column back pressure until buffet occurs. When buffet is felt, relax back pressure and smoothly roll out to straight and level. Notice that the controls are fully effective at all times.

UNCONFIDENTIAL
IF PRINTED

Rapid Descent

Appendix A.2.11

This section addresses basic techniques and procedures for a rapid descent. Some routes over mountainous terrain require careful operator planning to include carrying additional oxygen, special procedures, higher initial level off altitudes, and emergency routes in the event a depressurization is experienced. These requirements are normally addressed in an approved company route manual or other document that addresses route specific depressurization procedures.

This maneuver is designed to bring the airplane down smoothly to a safe altitude, in the minimum time, with the least possible passenger discomfort.

Note: Use of the autopilot is recommended.

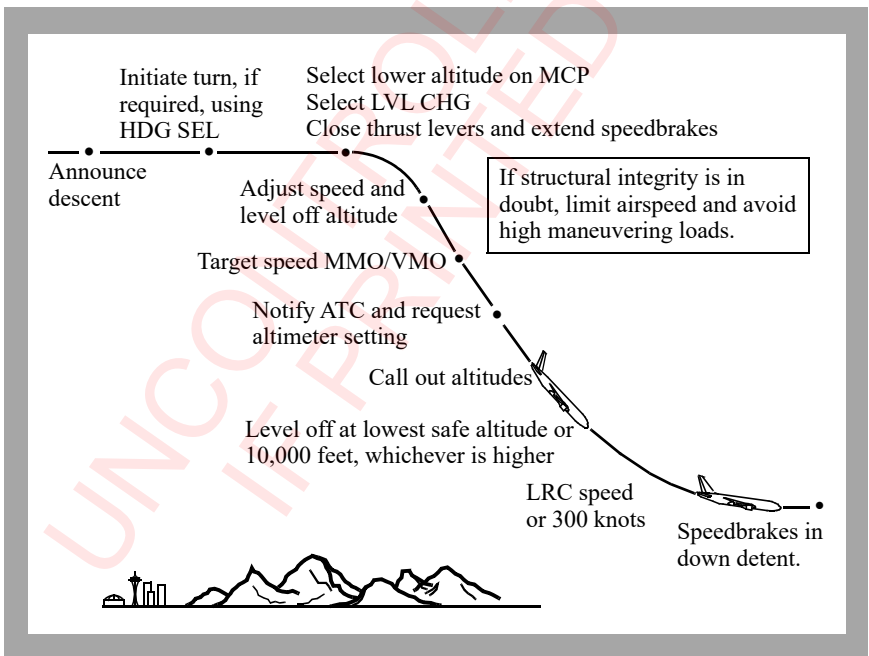

If the descent is performed because of a rapid loss of cabin pressure, crewmembers should place oxygen masks on and establish communication at the first indication of a loss of cabin pressurization. Verify cabin pressure is uncontrollable, and if so begin descent. If structural damage exists or is suspected, limit airspeed to current speed or less. Avoid high maneuvering loads.

Perform the maneuver deliberately and methodically. Do not be distracted from flying the airplane. If icing conditions are entered, use anti-ice and thrust as required.

Note: Rapid descents are normally made with the landing gear up.

The PM checks the lowest safe altitude, notifies ATC, and obtains an altimeter setting (QNH). Both pilots should verify that all memory items have been accomplished and call out any items not completed. The PM calls out 2,000 feet and 1,000 feet above the level off altitude.

Level off at the lowest safe altitude or 10,000 feet, whichever is higher. Lowest safe altitude is the Minimum Enroute Altitude (MEA), Minimum Off Route Altitude (MORA), or any other altitude based on terrain clearance, navigation aid reception, or other appropriate criteria.

If severe turbulent air is encountered or expected, reduce to the turbulent air penetration speed.

Autopilot Entry and Level Off

Level Change (LVL CHG)

Because of airspeed and altitude protection and reduced crew workload, use of the autopilot with LVL CHG mode is the recommended technique for rapid descents. Use of the V/S mode is not recommended.

Initiate a turn, if required, using HDG SEL. Set a lower altitude in the altitude window. Select LVL CHG, close the thrust levers and smoothly extend the speedbrakes. Autothrottle should be left connected. The airplane pitches down smoothly while the thrust levers retard to idle. Adjust the speed as needed and ensure the altitude window is correctly set for the level off. During descent, the IAS/MACH speed window changes from MACH to IAS at approximately 300 KIAS. Manually reset to VMO as needed.

When descending at speeds near VMO/MMO with the autopilot engaged, short-term airspeed increases above VMO/MMO may occur. These are most often due to wind and temperature changes. These short-term increases are acceptable for this maneuver and the autopilot should adjust the pitch to correct the airspeed to below VMO/MMO. Do not disengage the autopilot unless autopilot operation is clearly unacceptable. Any airspeed above VMO/MMO should be documented in the airplane logbook.

Note: For more complete information on recommendations if VMO/MMO is exceeded, see the section titled "Overspeed" in Chapter 8 of this manual.

737 NG Flight Crew Training Manual

When approaching the target altitude, ensure the altitude is set in the MCP altitude select window, and the command speed is set to LRC or approximately 300 knots before level-off is initiated. This aids in a smooth transition to level flight. When the speedbrakes are retracted during altitude capture near VMO/MMO, a momentary overspeed condition may occur. To avoid this condition, smoothly and slowly retract the speedbrakes to allow the autopilot sufficient time to adjust the pitch attitude to maintain the airspeed within limits.

Control Wheel Steering

Control Wheel Steering (CWS) may be used to reduce pilot workload. Follow the manually flown procedure but instead of disengaging the autopilot, engage CWS.

Manual Entry and Level Off

The entry may be accomplished on heading or a turn may be made to clear the airway or controlled track. However, since extending the speedbrakes initially reduces the maneuver margin, monitor the airspeed display and bank angle to ensure that at least minimum maneuver speed is maintained when turning.

To manually fly the maneuver, disconnect the autothrottle and retard thrust levers to idle. Smoothly extend the speedbrakes, disengage the autopilot and smoothly lower the nose to initial descent attitude (approximately 10° nose down).

About 10 knots before reaching target speed, slowly raise the pitch attitude to maintain target speed. Keep the airplane in trim at all times. If MMO/VMO is inadvertently exceeded, change pitch smoothly to decrease speed.

Approaching level off altitude, smoothly adjust pitch attitude to reduce rate of descent. The speedbrake lever should be returned to the down detent when approaching the desired level off altitude. After reaching level flight add thrust to maintain long range cruise or 300 knots.

Landing Gear Extended Descent

The rapid descent is normally made with the landing gear up. However, when structural integrity is in doubt and airspeed must be limited, extension of the landing gear may provide a more satisfactory rate of descent.

If the landing gear is to be used during the descent, comply with the landing gear placard speeds.

After Level Off

Recheck the pressurization system and evaluate the situation. Do not remove the crew oxygen masks if cabin altitude remains above 10,000 feet.

Note: Determine the new course of action based on weather, oxygen, fuel remaining, medical condition of crew and passengers, and available airports. Obtain a new ATC clearance.

Expedited Descent for Freighter Airplanes

This section describes general technique associated with accomplishing the CARGO FIRE NNC.

The expedited descent is a separate and different maneuver from the rapid descent. The rapid descent is designed to bring the airplane down smoothly to a safe altitude. The expedited descent maneuver is designed to maintain FL250 as long as possible. Descent from FL250 is only started when an expedited, uninterrupted descent to the lowest safe altitude or 3000 feet AFE at maximum airspeed can be accomplished. This shortens flight time below FL250 to minimize the severity of the fire in an oxygen rich environment. Intermediate level-off below FL250 and extended flight at low airspeeds are avoided.

There is no fire extinguishing capability for main deck cargo compartment fires. Fire protection requires isolating the fire and reducing the amount of oxygen available to the fire. Arming the main deck cargo fire arm switch shuts down ventilation sources and protects the occupied areas of the airplane from hazardous quantities of smoke. Pushing the cargo fire depressurization/discharge switch depressurizes the airplane and reduces the amount of oxygen available to the fire. Maintaining FL250 as long as practicable minimizes oxygen available to the fire, while accommodating flight crew physiological limits for extended flight on supplementary oxygen.

Descent

Proper descent planning is required to ensure the airplane arrives at the lowest safe altitude or 3,000 feet AFE in the shortest time. The checklist provides an approximate distance from an airport at sea level, in track miles, to begin the descent from FL250.

Do not delay the approach and landing once the descent is started. The checklist provides an approximate distance from the airport to begin decelerating for the approach and landing.

737 NG Flight Crew Training Manual

Distances must be adjusted for actual conditions, such as a headwind or tailwind, thrust requirements for anti-ice, or an airport elevation other than sea level.

Note: Creating two fixes and entering the distances on the BRG/DIS lines on the FMC FIX INFO page, one to mark the descent from FL250 and the other to mark the deceleration point, may assist in situational awareness and planning.

Note: Use of the autopilot, autothrottle, and LVL CHG mode is recommended to protect airspeed and altitude and reduce crew workload for the expedited descent. Use of V/S mode is not recommended.

Note: The use of autobrakes is recommended because autobrakes provide symmetrical braking and quicker application upon touchdown. However, when used properly, maximum manual braking provides the shortest stopping distance.

Approach

Precise approach planning is required to ensure the airplane is stabilized on final approach in the landing configuration, and to avoid a go-around. Approaching level off altitude of 3,000 feet AFE, or higher as appropriate, retract the speedbrakes before adding thrust. Retract speedbrakes smoothly while maintaining the selected speed. At 15 nm from the runway, set the MCP speed to approach speed and immediately extend the speedbrakes (prevents autothrottle advancement and provides shortest time to configure). Upon reaching flaps up speed, retract the speedbrakes. Extend flaps and landing gear on schedule. Plan a normal approach and landing. If circumstances dictate the use of speedbrakes with the flaps extended, high sink rates during the approach should be avoided.

When thrust requirements for anti-icing result in less than normal descent rates with the speedbrakes extended, slowing sooner than 15 nm from the runway and extending the landing gear sooner than in the normal configuration sequence may be accomplished.

Note: Use of the autopilot and autothrottle with the APP mode is the recommended technique for the approach and landing. Use of the V/S mode is not recommended.

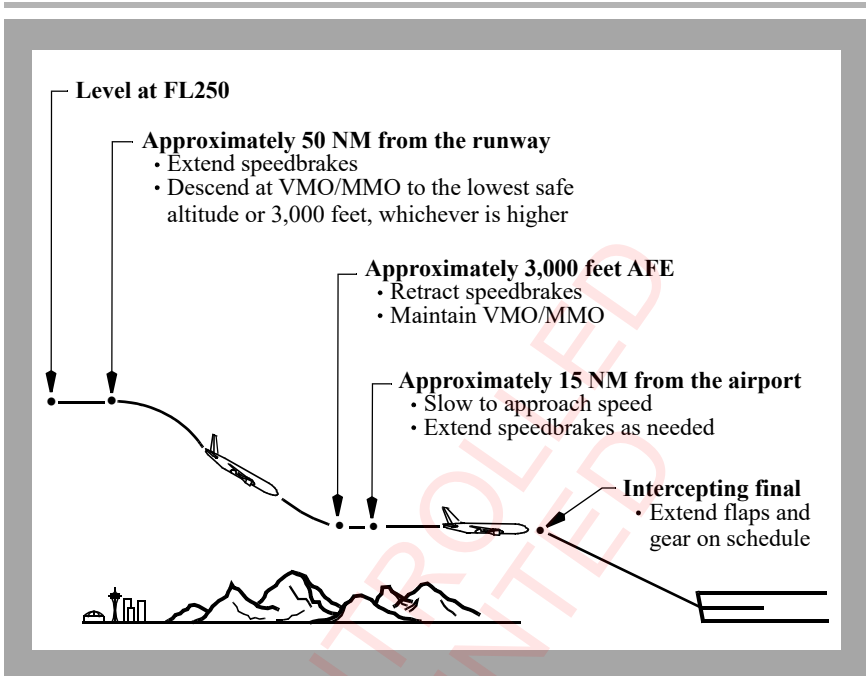

UNCONTROLLED
IF PRINTED

Approach to Stall or Stall

An approach to a stall is a controlled flight maneuver; a stall is an out-of-control, but recoverable, condition. However, the recovery maneuver is the same for either an approach to a stall or a fully developed stall.

Most approach to stall incidents have occurred where there was altitude available for recovery. The incidents that progressed into accidents often occurred because the crew failed to make a positive recovery when the stall warning occurred, the condition progressed to a full stall, and the airplane impacted the ground in a stalled condition. For this reason, emphasis has shifted from a recovery with minimum loss of altitude to reducing the angle of attack below the wing stalling angle of attack to complete a positive and efficient recovery.

A stall warning should be readily identifiable by the pilot, either by an artificial indication (stick shaker) or natural indication (initial buffet). During the initial stages of a stall, local airflow separation results in buffeting, giving a natural warning of an approach to stall. Stick shaker operation will usually precede initial buffet as a stall warning indication. In some cases, near cruise altitude and cruise Mach, stick shaker may be simultaneous with initial buffet.

Recovery from an approach to stall should be initiated at the earliest recognizable stall warning, either stick shaker or initial buffet.

An airplane may be stalled in any attitude (nose high, nose low, high or low angle of bank) or any airspeed (turning, accelerated stall). It is not always intuitively obvious that the airplane is stalled.

An airplane stall is characterized by one or more of the following conditions:

- stall warning
 - artificial (stick shaker)
 - natural (buffet which could be heavy at times) or
- lack of pitch authority
- lack of roll control
- inability to arrest descent rate.

Approach to Stall or Stall Recovery

To initiate the recovery, the angle of attack must be reduced below the wing stalling angle of attack. Smoothly apply nose down elevator to reduce the angle of attack until the wings are unstalled (buffet or stick shaker stops). Nose down stabilizer trim may be needed if the control column does not provide the needed response.

Note: With high thrust engines, low airspeed coupled with high thrust settings may result in a condition where elevator authority is not adequate. This is because airplanes with underwing-mounted engines have a nose-up pitch moment relative to increased thrust.

Application of forward control column (as much as full forward may be required) and the use of some nose-down stabilizer trim should provide sufficient elevator control to produce a nose-down pitch rate. It may be difficult to know how much stabilizer trim to use, and care must be taken to avoid using too much. Pilots should not fly the airplane using stabilizer trim, and should stop trimming nose down when they feel the g force on the airplane lessen or the required elevator force lessen. The use of too much trim may result in the loss of control or high structural loads.

Continue the recovery by rolling in the shortest direction to wings level, as needed. If an attempt is made to roll to wings level before the wings are unstalled, the ailerons and spoilers are ineffective. Unloading the wing by maintaining continuous nose-down elevator pressure keeps the wing angle of attack low making the normal roll controls more effective. After the stall is broken, normal roll controls, up to full deflection of ailerons and spoilers, may be used to roll in the shortest direction to wings level, if needed. The use of rudder is normally not needed.

The pilot flying advances the thrust levers as needed to accelerate and promptly return the airplane to the desired energy state. Advance thrust levers smoothly because underwing-mounted engines cause a nose-up pitch moment when thrust is increased. Under certain conditions, where high thrust settings are already applied such as during takeoff or go-around, a reduction of thrust can be needed in order to prevent the angle of attack from continuing to increase.

Note: Use care during recovery from a nose low attitude after the buffet and/or stick shaker have stopped. If the pull up is too aggressive, a “secondary” stall or sustained stick shaker can result.

737 NG Flight Crew Training Manual

In extreme cases where the application of forward control column coupled with some nose-down stabilizer trim and a thrust reduction do not stop an increasing pitch rate in a nose high situation, rolling the airplane to a bank angle that starts the nose down can be effective. If normal roll control is ineffective, careful rudder input in the direction of the desired roll can be needed. Bank angles of about 45°, up to a maximum of 60°, could be needed. Too much rudder applied too quickly or held too long can result in loss of lateral and directional control.

Do not change gear or flap configuration during the recovery, unless a stall warning indication is encountered during liftoff and the flaps were inadvertently positioned up for takeoff. In this case, extend flaps 1 as directed in the Approach to Stall or Stall Recovery maneuver. Extending or retracting the flaps during the recovery at other times results in an increased altitude loss.

High Altitude Recovery

At higher altitudes, normally above 20,000 feet, the airplane becomes increasingly thrust limited. If an approach to stall indication is experienced, nose down elevator and stabilizer trim is needed to initiate a descent. This is because when the airplane is thrust limited, altitude needs to be traded for airspeed. Therefore a recovery at high altitude results in a greater altitude loss than a recovery at low altitudes.

Low Altitude Recovery

During the approach to stall or stall recovery maneuver at low altitude, where ground contact is a factor, the pilot monitoring calls out any trend toward ground contact. If a stall warning is received shortly after takeoff, the pilot flying smoothly adjusts pitch to reduce AOA while avoiding ground contact, if the flaps are up call for flaps 1.

Certain system failures can cause erroneous stick shaker activation after liftoff. If an erroneous stick shaker is activated continuously and airspeed is V₂ or greater and vertical speed is positive, continue climbout to acceleration height while monitoring altitude and airspeed.

Approach to Stall or Stall Recovery Training

The objective of the approach to stall or stall recovery training is to familiarize the pilot with the stall warning and correct recovery techniques. Recent safety studies have shown that an increasing number of stall related accidents have occurred during the maneuvering and approach phases of flight. In an effort to reduce this trend, training emphasis has shifted to performing stall or stall recovery exercises in these phases of flight.

Approach to Stall or Stall Recovery training maneuvers should be done under simulated instrument conditions with the autopilot engaged. Exercises include:

- level off
- turning base
- ILS final approach.

Initial Conditions

Set the command speed in accordance with normal procedures for the phase of flight. During the level off exercise, the speedbrake remains extended until retracted during the Approach to Stall or Stall Recovery maneuver. After the initial conditions are established, the instructor initiates each exercise by disconnecting the autothrottle and placing the thrust levers to idle.

Indications of the approach to a stall are also indicated on the airspeed display. See the section titled Maneuver Speeds and Margins in chapter 1 of this manual for a discussion of amber band displays and the FCOM for airspeed low and minimum speed displays.

The airspeed low indication will be initiated during the entry to the maneuver. The airspeed low indication should be ignored only for the purpose of training the maneuver.

Initial Buffet - Stick Shaker

The autopilot slowly establishes a pitch attitude by using stabilizer trim and/or elevator position to induce the stall buffet or stick shaker.

During the initial stages of the stall, local airflow separation results in buffeting giving a natural warning of an approach to stall. A stall warning should be readily identifiable by the pilot, either by initial buffet indication or an artificial indication (stick shaker).

Effect of Flaps

Flaps are used to increase low speed performance capability. The leading edge devices ensure that the inboard wing stalls before the outboard wing. This causes the nose of the airplane to pitch down at the onset of the stall.

Effect of Speedbrakes

For any given airspeed, the angle of attack is higher with the speedbrakes up. This increases initial buffet speed and stick shaker speed but has less effect on the actual stall speed.

Recovery

Recovery from an approach to stall should be initiated at the earliest recognizable stall warning, either initial buffet or stick shaker. Initiate the Approach to Stall or Stall Recovery maneuver as published in the QRH.

737 NG Flight Crew Training Manual

Apply nose down elevator and, if needed, nose down stabilizer trim to reduce the angle of attack. Thrust is increased as needed to accelerate. Subsequently the stall buffet and the stick shaker will stop. Maintain lateral control with ailerons.

Do not use flight director commands during the recovery. Flight director commands are not designed to provide guidance that leads to a recovery from an approach to stall or stall.

Approach to Stall Recovery Exercises

The following exercises are intended for simulator training only.

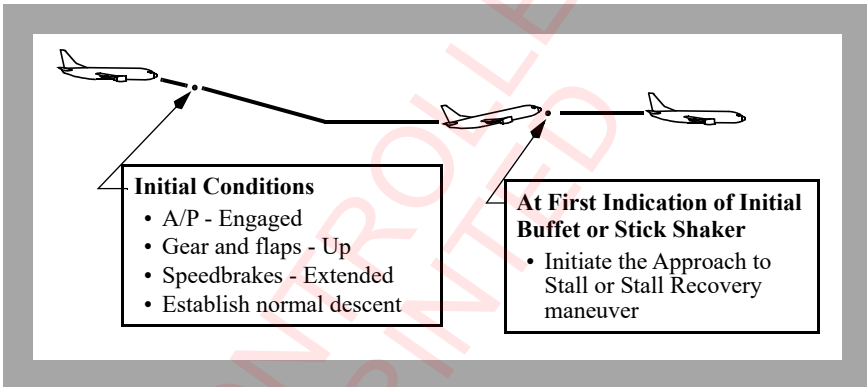
Level Off

Turning Base

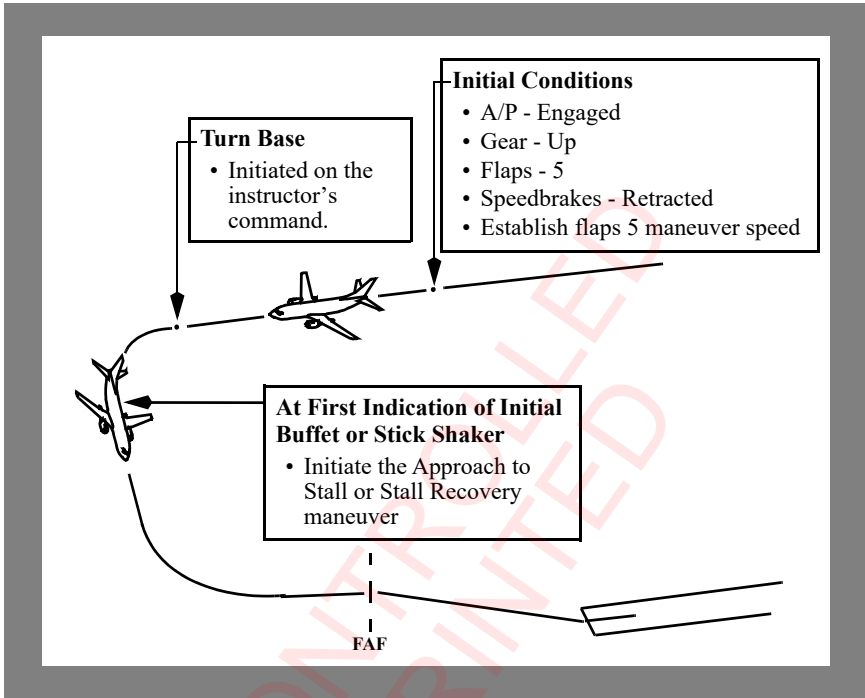

Note: The instructor commands initiation of the turn to base when the airspeed is at minimum maneuver speed (top of the amber band), or at flap 5 maneuver speed for airplanes without an amber band display. This ensures the initial buffet or stick shaker occurs during the turn.

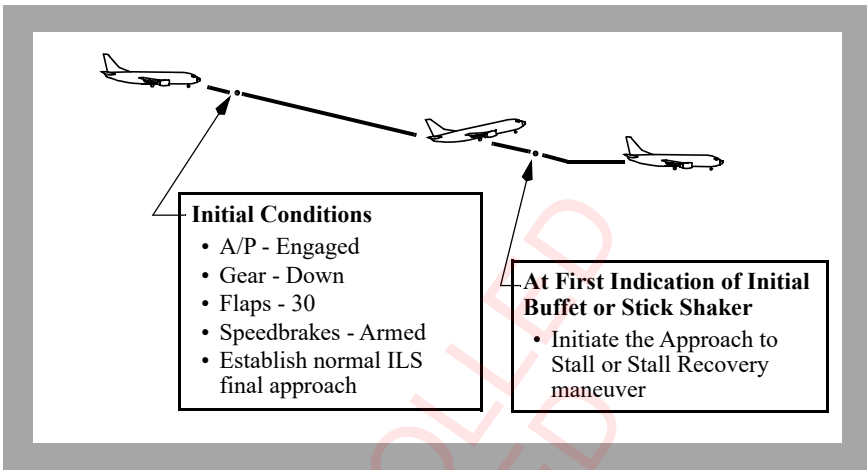
737 NG Flight Crew Training Manual
ILS Final Approach

Note: If during the ILS final approach exercises the decision is made to go-around, the Approach to Stall or Stall Recovery maneuver must be completed before the go-around is initiated.

Completion of the Recovery

Upon completion of the maneuver, recover to the command speed, adjust thrust as needed, and follow previous instructions (e.g. heading, altitude). Re-engage the autopilot and autothrottle in accordance with normal procedures.

Steep Turns

The objective of the steep turn maneuver is to familiarize the pilot with airplane handling characteristics beyond 35° of bank and improve the instrument crosscheck. During training, 45° of bank is used for this maneuver. It is not intended that the pilot should ever be required to bank greater than 25° to 30° in any normal or non-normal condition. The use of display features such as the HUD or PFD Flight Path Vector can be used.

Note: Stabilizer trim is not recommended during the steep turn maneuver because of increased workload during roll out.

Entry

Stabilize airspeed at 250 knots on heading and altitude. Use a normal turn entry. An increase in pitch is required as the bank angle is increased to maintain constant altitude. An increase in thrust is required to maintain constant airspeed.

During Turn

Pitch and thrust control are the same as for a normal turn; however, larger pitch adjustments are required for a given altitude deviation. Varying the angle of bank while turning makes pitch control more difficult. If altitude loss becomes excessive, reduce the angle of bank as needed to regain positive pitch control.

Smooth and positive control is required. A rapid instrument scan is required to detect deviations early enough to be corrected by small adjustments.

Attitude Indicator

The attitude indicator is reliable for accurate pitch and bank information throughout the turn. Precession error does not exist because the IRS is the source of attitude information.

Vertical Speed Indicator

IRS vertical speed indications are reliable during the turn.

Altimeter

Crosscheck the direction and rate of change, and make smooth minor adjustments to the pitch attitude for corrections.

Airspeed

Airspeed changes very slowly because of small changes in thrust and drag. Anticipate thrust changes and apply them at the first indication of change on the airspeed indicator or speed tape (as installed). An increase in thrust is required as bank angle increases.

Rollout

Roll out at the same rate as used during normal turns. Normally rollout should begin 15° to 20° prior to the desired heading. A decrease in pitch is required as the bank angle is decreased to maintain constant altitude. A decrease in thrust is required to maintain constant airspeed.

Terrain Avoidance

The Ground Proximity Warning System (GPWS) PULL UP Warning occurs when an unsafe distance or closure rate is detected with terrain below the airplane. The Look-ahead terrain alerting (as installed) also provides an aural warning when an unsafe distance is detected from terrain ahead of the airplane. Immediately accomplish the Terrain Avoidance maneuver found in the non-normal maneuvers section in the QRH.

Do not attempt to engage the autopilot and/or autothrottle until terrain clearance is assured.

Terrain Avoidance - RNAV (RNP) AR Operations

Appendix A.2.12

During RNAV (RNP) AR operations in close proximity to terrain on departure or approach, crews may experience occasional momentary terrain caution-level alerts. If these alerts are of short duration and have ceased, crews should verify they are on the required path and consider continuing the procedure using LNAV and VNAV. Depending upon where initiation occurs, the risks of terrain contact while executing a terrain avoidance maneuver may be higher than continuing on the required track.

Terrain warning-level alerts always require immediate action. The most appropriate crew actions regarding airplane bank angle and track during a terrain avoidance maneuver depend on where the maneuver is initiated. Operators should determine the most appropriate course of action for each leg of the procedure, if necessary, so crews are prepared to react correctly at all times.

Traffic Alert and Collision Avoidance System

The Traffic Alert and Collision Avoidance System (TCAS) is designed to enhance crew awareness of nearby traffic and issue advisories for timely visual acquisition or appropriate vertical flight path maneuvers to avoid potential collisions. It is intended as a backup to visual collision avoidance, application of right-of-way rules and ATC separation.

Use of TA/RA, TA Only, and Transponder Only Modes

TCAS operation should be initiated just before takeoff and continued until just after landing. Whenever practical, the system should be operated in the TA/RA mode to maximize system benefits. Operations in the Traffic Advisory (TA) Only or TCAS Off (Transponder Only) modes, to prevent nuisance advisories and display clutter, should be in accordance with operator policy.

The responsibility for avoiding collisions still remains with the flight crew and ATC. Pilots should not become preoccupied with TCAS advisories and displays at the expense of basic airplane control, normal visual lookout and other crew duties.

Traffic Advisory

A Traffic Advisory (TA) occurs when nearby traffic meets system minimum separation criteria, and is indicated aurally and visually on the TCAS traffic display. A goal of the TA is to alert the pilot of the possibility of an RA. If a TA is received, immediately accomplish the Traffic Avoidance Maneuver in the QRH.

Maneuvers based solely on a TA may result in reduced separation and are not recommended.

The TA ONLY mode may be appropriate under the following circumstances:

- during takeoff toward known nearby traffic (in visual contact) which would cause an unwanted RA during initial climb
- during closely spaced parallel runway approaches
- when flying in known close proximity to other airplanes
- in circumstances identified by the operator as having a verified and significant potential for unwanted or undesirable RAs
- engine out operation.

Resolution Advisory

When TCAS determines that separation from approaching traffic may not be sufficient, TCAS issues a Resolution Advisory (RA) aural warning and a pitch command. Maneuvering is required if any portion of the airplane symbol is within the red region on the attitude indicator. Flight crews should follow RA commands using established procedures unless doing so would jeopardize the safe operation of the airplane. If an RA is received, immediately accomplish the Traffic Avoidance maneuver in the QRH.

Resolution advisories are known to occur more frequently at locations where traffic frequently converges (e.g. waypoints). This is especially true in RVSM airspace. Climb or descent profiles should not be modified in anticipation of avoiding an RA unless specifically requested by ATC.

RA maneuvers require only small pitch attitude changes which should be accomplished smoothly and without delay. Properly executed, the RA maneuver is mild and does not require large or abrupt control movements. Remember that the passengers and flight attendants may not all be seated during this maneuver. The flight director is not affected by TCAS guidance. Therefore, when complying with an RA, flight director commands may be followed only if they result in a vertical speed that satisfies the RA command.

On airplanes equipped with TCAS 7.0 and earlier, there have been reports of some flight crews responding incorrectly to the RA “ADJUST VERTICAL SPEED ADJUST” (AVSA) by increasing rather than decreasing vertical speed. Flight crews should be aware that an AVSA always requires a reduction in vertical speed. Follow QRH procedures and comply with the RA commanded vertical speed.

On airplanes equipped with TCAS 7.1 and later, the “ADJUST VERTICAL SPEED ADJUST” RA has been changed to “LEVEL-OFF, LEVEL-OFF”.

During the RA maneuver, the aircrew attempts to establish visual contact with the target. However, visual perception of the encounter can be misleading, particularly at night. The traffic acquired visually may not be the same traffic causing the RA.

737 NG Flight Crew Training Manual

Pilots should maintain situational awareness since TCAS may issue RAs in conflict with terrain considerations, such as during approaches into rising terrain or during an obstacle limited climb. Continue to follow the planned lateral flight path unless visual contact with the conflicting traffic requires other action. Windshear, GPWS, and stall warnings take precedence over TCAS advisories. Stick shaker must take priority at all times. Complying with RAs may result in brief exceedance of altitude and/or placard limits. However, even at the limits of the operating envelope, in most cases sufficient performance is available to safely maneuver the airplane. Smoothly and expeditiously return to appropriate altitudes and speeds when clear of conflict. Maneuvering opposite to an RA command is not recommended since TCAS may be coordinating maneuvers with other airplanes.

HUD Advisories

TCAS RAs alert the pilot of traffic conflicts by displaying preventive and corrective advisory symbols on the HUD. These advisories indicate that corrective action is required (corrective advisory) or that a potential threat exists (preventive advisory). Corrective advisories require the pilot to take positive evasive action to position the flight path vector so it satisfies the command for vertical separation. Preventive advisories do not require any immediate evasive action to be taken by the pilot, but indicate an unsafe zone. The pilot should keep the flight path vector clear of the unsafe zone.

At times there may be a situation where traffic is both above and below the airplane. In these cases, both corrective and preventive advisories may be displayed.

Upset Prevention and Recovery

For detailed information regarding the nature of upsets, aerodynamic principles, recommended training and other related information, refer to the Airplane Upset Prevention & Recovery Training Aid (AUPRTA) available through your operator and on the ICAO website.

Historically, an upset has been defined as unintentionally exceeding any one or more of the following conditions:

- pitch attitude greater than 25° nose up
- pitch attitude greater than 10° nose down
- bank angle greater than 45°
- less than the above parameters but flying at an airspeed inappropriate for the conditions.

The latest revision of AUPRTA concludes that an upset condition exists any time that an airplane is deviating from the intended airplane state. The AUPRTA has been updated to emphasize the importance of recognition and avoidance of situations that can lead to airplane upsets and to improve a pilot's ability to recover control of an airplane that deviates from the intended airplane state. An airplane upset can involve pitch or roll angle deviations as well as inappropriate airspeeds for the conditions.

With the focus on upset recognition and avoidance, pilots should understand how to operate the airplane throughout the entire operational flight envelope. Pilots should have practical knowledge of and demonstrate proficiency in airplane performance and handling characteristics.

Upset prevention and recovery training should emphasize the entire operational flight envelope to develop pilot awareness and handling skills in both manual and automated flight. (See Automation Use Guidelines in Appendix 2).

Upset Recovery Maneuvers

If an upset situation is recognized, immediately accomplish the Upset Recovery maneuver found in the non-normal maneuvers section in the QRH.

It is possible to consolidate upset recovery maneuvers into two basic scenarios, nose high and nose low, and to acknowledge the potential for high bank angles in each scenario. Recognizing and confirming the upset, reducing automation, and completing the recovery are included in the Upset Recovery maneuvers in the QRH. The maneuvers provide a logical progression for recovering the airplane.

To recognize and confirm the situation the crew must assess the airplane attitude, airspeed, altitude and trend information through instrument crosscheck.

The ADI should be used as the primary reference in assessing airplane attitude. The pitch scales and color coding above/below the horizon (blue/brown) should be used when making the pitch assessment.

For any pitch attitude, the bank pointer stays perpendicular to the horizon. When completing the upset recovery maneuver, roll the shortest direction to wings level (toward the bank pointer).

Though flight crews in line operation rarely, if ever, encounter an upset situation, understanding how to apply aerodynamic fundamentals in such a situation helps them control the airplane. Several techniques are available for recovering from an upset. In most situations, if a technique is effective, it is not recommended that pilots use additional techniques. Several of these techniques are discussed in the example scenarios below:

- stall recovery
- nose high, wings level
- nose high, high bank angles

737 NG Flight Crew Training Manual

- nose low, wings level
- nose low, high bank angles
- high bank angles

Note: Higher than normal control forces may be required to control the airplane attitude when recovering from upset situations. Be prepared to use a firm and continuous force on the control column and control wheel to complete the recovery.

Stall Recovery

In all upset situations, it is necessary to recover from a stall before applying any other recovery actions. A stall may exist at any attitude and may be recognized by one or more of the following:

- stall warning
 - artificial (stick shaker)
 - natural (buffet which could be hard at times) or
- lack of pitch authority
- lack of roll control
- inability to arrest descent rate.

If the airplane is stalled, recovery from the stall must be accomplished first by applying and maintaining nose down elevator until stall recovery is complete and stall warning ceases. Under certain conditions, it may be necessary to reduce some thrust in order to prevent the angle of attack from continuing to increase. Once stall recovery is complete, upset recovery actions may be taken and thrust reapplied as needed.

Nose High**Nose High, Wings Level**

If the airplane pitch attitude is unintentionally high the airspeed can be decreasing rapidly. As airspeed decreases, the pilot's ability to maneuver the airplane also decreases. If the stabilizer trim setting is nose up, as for slow-speed flight, it partially reduces the nose-down authority of the elevator. Further complicating this situation, as the airspeed decreases, the pilot could intuitively make a large thrust increase. This causes an additional pitch up. At full thrust settings and very low airspeeds, the elevator, working in opposition to the stabilizer, has limited control to reduce the pitch attitude.

In this situation the pilot should trade altitude for airspeed, and maneuver the airplane's flight path back toward the horizon. This is accomplished by the input of up to full nose-down elevator and the use of some nose-down stabilizer trim. These actions should provide sufficient elevator control power to produce a nose-down pitch rate. It may be difficult to know how much stabilizer trim to use, and care must be taken to avoid using too much trim. Pilots should not fly the airplane using stabilizer trim, and should stop trimming nose down when they feel the g force on the airplane lessen or the required elevator force lessen. This use of stabilizer trim may correct an out-of-trim airplane and solve a less-critical problem before the pilot must apply further recovery measures. Because a large nose-down pitch rate results in a condition of less than 1 g, at this point the pitch rate should be controlled by modifying control inputs to maintain between 0 g and 1 g. If altitude permits, flight tests have determined that an effective way to achieve a nose-down pitch rate is to reduce some thrust.

If normal pitch control inputs do not stop an increasing pitch rate, rolling the airplane to a bank angle that starts the nose down should work. Bank angles of about 45°, up to a maximum of 60°, could be needed. Unloading the wing by maintaining continuous nose-down elevator pressure keeps the wing angle of attack as low as possible, making the normal roll controls as effective as possible. With airspeed as low as stick shaker onset, normal roll controls - up to full deflection of ailerons and spoilers - may be used. The rolling maneuver changes the pitch rate into a turning maneuver, allowing the pitch to decrease. Finally, if normal pitch control then roll control is ineffective, careful rudder input in the direction of the desired roll may be required to induce a rolling maneuver for recovery.

Only a small amount of rudder is needed. Too much rudder applied too quickly or held too long may result in loss of lateral and directional control. Because of the low energy condition, pilots should exercise caution when applying rudder.

The reduced pitch attitude allows airspeed to increase, thereby improving elevator and aileron control effectiveness. After the pitch attitude and airspeed return to a desired range the pilot can reduce angle of bank with normal lateral flight controls and return the airplane to normal flight.

Nose High, High Bank Angles

A nose high, high angle of bank upset requires deliberate flight control inputs. A large bank angle is helpful in reducing excessively high pitch attitudes. The pilot must apply nose-down elevator and adjust the bank angle to achieve the desired rate of pitch reduction while considering energy management. Once the pitch attitude has been reduced to the desired level, it is necessary only to reduce the bank angle, ensure that sufficient airspeed has been achieved, and return the airplane to level flight.

Nose Low

Nose Low, Wings Level

If the airplane pitch attitude is unintentionally low, the airspeed can be increasing rapidly. A pilot would likely reduce thrust and extend the speedbrakes. Thrust reduction causes an additional nose-down pitching moment. Speedbrake extension causes a nose-up pitching moment, an increase in drag, and a decrease in lift for the same angle of attack. At airspeeds well above VMO/MMO, the ability to command a nose-up pitch rate with elevator may be reduced because of the extreme aerodynamic loads on the elevator.

Again, it is necessary to maneuver the airplane's flight path back toward the horizon. At moderate pitch attitudes, applying nose-up elevator, reducing thrust, and extending speedbrakes, if necessary, changes the pitch attitude to a desired range. At extremely low pitch attitudes and high airspeeds (well above VMO/MMO), nose-up elevator and nose-up trim may be required to establish a nose-up pitch rate.

Nose Low, High Bank Angles

The nose low, high angle of bank upset requires prompt action by the pilot as altitude is rapidly being exchanged for airspeed. Even if the airplane is at a high enough altitude that ground impact is not an immediate concern, airspeed can rapidly increase beyond airplane design limits. Simultaneous application of roll and adjustment of thrust may be necessary. It may be necessary to apply nose-down elevator to limit the amount of lift, which will be acting toward the ground if the bank angle exceeds 90°. This also reduces wing angle of attack to improve roll capability. Full aileron and spoiler input should be used if necessary to smoothly establish a recovery roll rate toward the nearest horizon. It is important to not increase g force or use nose-up elevator or stabilizer until approaching wings level. The pilot should also extend the speedbrakes as needed.

High Bank Angles

If the airplane is not in “zero-angle-of-bank” flight, lift created by the wings is not being fully applied against gravity, and more than 1 g is required for level flight. At bank angles greater than 67°, level flight cannot be maintained within AFM load factor limits. In high bank angle increasing airspeed situations, the primary objective is to maneuver the lift of the airplane to directly oppose the force of gravity by rolling in the shortest direction to wings level. Applying nose-up elevator at bank angles above 60° causes no appreciable change in pitch attitude and may exceed normal structure load limits as well as the wing angle of attack for stall. The closer the lift vector is to vertical (wings level), the more effective the applied g is in recovering the airplane.

A smooth application of up to full lateral control should provide enough roll control power to establish a very positive recovery roll rate. If full roll control application is not satisfactory, it may even be necessary to apply some rudder in the direction of the desired roll.

Only a small amount of rudder is needed. Too much rudder applied too quickly or held too long may result in loss of lateral and directional control or structural failure.

Windshear

General

Improper or ineffective vertical flight path control has been one of the primary factors in many cases of flight into terrain. Low altitude windshear encounters are especially significant because windshear can place the crew in a situation which requires the maximum performance capability of the airplane. Windshear encounters near the ground are the most threatening because there is very little time or altitude to respond to and recover from an encounter.

Airplane Performance in Windshear

Knowledge of how windshear affects airplane performance can be essential to the successful application of the proper vertical flight path control techniques during a windshear encounter.

The wind component is mostly horizontal at altitudes below 500 feet. Horizontal windshear may improve or degrade vertical flight path performance. Windshear that improves performance is first indicated in the flight deck by an increasing airspeed. This type of windshear may be a precursor of a shear that decreases airspeed and degrades vertical flight path performance.

Airspeed decreases if the tailwind increases, or headwind decreases, faster than the airplane is accelerating. As the airspeed decreases, the airplane normally tends to pitch down to maintain or regain the in-trim speed. The magnitude of pitch change is a function of the encountered airspeed change. If the pilot attempts to regain lost airspeed by lowering the nose, the combination of decreasing airspeed and decreasing pitch attitude produces a high rate of descent. Unless this is countered by the pilot, a critical flight path control situation may develop very rapidly. As little as 5 seconds may be available to recognize and react to a degrading vertical flight path.

In critical low altitude situations, trade airspeed for altitude, if possible. An increase in pitch attitude, even though the airspeed may be decreasing, increases the lifting force and improves the flight path angle. Proper pitch control, combined with maximum available thrust, utilizes the total airplane performance capability.

737 NG Flight Crew Training Manual

The crew must be aware of the normal values of airspeed, altitude, rate of climb, pitch attitude and control column forces. Unusual control column force may be required to maintain or increase pitch attitude when airspeed is below the in-trim speed. If significant changes in airspeed occur and unusual control forces are required, the crew should be alerted to a possible windshear encounter and be prepared to take action.

Avoidance, Precautions and Recovery

Crew actions are divided into three areas: Avoidance, Precautions and Recovery. For more information on avoidance and precautions, see the Windshear Supplementary Procedure in Volume 1 of the FCOM. For specific crew actions for recovery, see the Non-Normal Maneuvers section in the QRH.

UNCONTROLLED
IF PRINTED



Intentionally
Blank

UNCONTROLLED
IF PRINTED



Non-Normal Operations

Chapter 8

Table of Contents

Section TOC

Preface 8.1

Non-Normal Situation Guidelines 8.2

 Flight Crew Alerting System 8.3

 Detection of Flight Crew Alerts 8.3

 Examples of Non-Normal Situations 8.4

Troubleshooting 8.11

Approach and Landing 8.11

Landing at the Nearest Suitable Airport 8.12

Air Systems 8.13

 Cabin Altitude Warning 8.13

Ditching 8.14

 Send Distress Signals 8.14

 Advise Crew and Passengers 8.14

 Fuel Burn-Off 8.14

 Passenger Cabin Preparation 8.14

 Ditching Final 8.14

 Initiate Evacuation 8.15

Engines, APU 8.15

 Engine Oil System Indications 8.15

 Engine Failure versus Engine Fire After Takeoff 8.15

 Engine Tailpipe Fire 8.15

 Loss of Engine Thrust Control 8.16

 Loss of Thrust on Both Engines 8.17

 Airframe Vibration Due to Engine Severe Damage or Separation 8.18

 Recommended Technique for an In-Flight Engine Shutdown 8.18

 Bird Strikes 8.19

Evacuation	8.20
Method of Evacuation	8.20
Discharging Fire Bottles During an Evacuation	8.21
Flight Controls	8.21
Leading Edge or Trailing Edge Device Malfunctions	8.21
Flap Extension using the Alternate System	8.23
Jammed or Restricted Flight Controls	8.24
Stabilizer Trim Inoperative	8.26
Runaway Stabilizer	8.27
Manual Stabilizer Trim	8.27
Standby Rudder On	8.28
Flight Instruments, Displays	8.29
Airspeed Unreliable	8.29
Altitude Unreliable	8.33
Erroneous Angle of Attack (AOA) Indications	8.34
Fuel	8.34
Fuel Balance	8.34
Fuel Leak	8.35
Low Fuel	8.36
Hydraulics	8.37
Hydraulic System(s) Inoperative - Landing	8.37
Landing Gear	8.38
Landing Gear Lever Jammed in the Up Position	8.38
Tire Failure During or After Takeoff	8.39
Landing on a Flat Tire	8.40
Partial or Gear Up Landing	8.40
Overspeed	8.43

737 NG Flight Crew Training Manual

Tail Strike	8.44
Takeoff Risk Factors	8.44
Landing Risk Factors	8.45
Warning Systems	8.47
Fire	8.48
Cargo Fire	8.48
Wheel Well Fire	8.48
Windows	8.49
Window Damage	8.49
Flight with the Side Window(s) Open	8.49
Situations Beyond the Scope of Non-Normal Checklists	8.50
Basic Aerodynamics and Systems Knowledge	8.50
Flight Path Control	8.52
Directional Control During Landing Ground Roll	8.52
Checklists with Memory Steps	8.52
Communications	8.53
Damage Assessment and Airplane Handling Evaluation	8.53
Landing Airport	8.54

Intentionally
Blank

UNCONTROLLED
IF PRINTED



Preface

This chapter describes pilot techniques associated with accomplishing selected Non-Normal Checklists (NNCs) and provides guidance for situations beyond the scope of NNCs. Aircrews are expected to accomplish NNCs listed in the QRH. These checklists ensure maximum safety until appropriate actions are completed and a safe landing is accomplished. Techniques discussed in this chapter minimize workload, improve crew coordination, enhance safety, and provide a basis for standardization. A thorough review of the QRH section CI.2, (Checklist Instructions, Non-Normal Checklists), is an important prerequisite to understanding this chapter.

UNCONTROLLED
IF PRINTED

Non-Normal Situation Guidelines

When a non-normal situation occurs, the following guidelines apply:

- **NON-NORMAL RECOGNITION:** The crewmember recognizing the malfunction calls it out clearly and precisely
- **MAINTAIN AIRPLANE CONTROL:** It is mandatory that the Pilot Flying (PF) fly the airplane while the Pilot Monitoring (PM) maintains situational awareness and supports the Pilot Flying to ensure obstacle clearance and airplane control. Maximum use of the autoflight system is recommended to reduce crew workload
- **ANALYZE THE SITUATION:** NNCs should be accomplished only after the desired flight path and appropriate configuration are correctly established. Review all warning lights, caution lights and other alerts to positively identify the malfunctioning system(s). In the event of multiple malfunctions, the flight crew needs to analyze the situation, use good judgment and determine which NNC takes priority.

Note: Pilots should don oxygen masks and establish crew communications anytime oxygen deprivation or air contamination is suspected, even though an associated warning has not occurred.

- **TAKE THE PROPER ACTION:** Although some in-flight non-normal situations require immediate corrective action, difficulties can be compounded by the rate the PF issues commands and the speed of execution by the PM. Commands must be clear and concise, allowing time for acknowledgment of each command prior to issuing further commands. The PF must exercise positive control by allowing time for acknowledgment and execution. The other crewmembers must be certain their reports to the PF are clear and concise, neither exaggerating nor understating the nature of the non-normal situation. This eliminates confusion and ensures efficient, effective, and expeditious handling of the non-normal situation. In the event of multiple malfunctions, consider doing memory items first followed by reference steps. Upon completion of an NNC, review all warning lights, caution lights and other alerts to determine the need to do other NNCs
- **EVALUATE THE NEED TO LAND:** If the NNC directs the crew to plan to land at the nearest suitable airport, or if the situation is so identified in the QRH section CI.2, (Checklist Instructions, Non-Normal Checklists), diversion to the nearest airport where a safe landing can be accomplished is required. If the NNC or the Checklist Instructions do not direct landing at the nearest suitable airport, the pilot must determine if continued flight to destination may compromise safety.

Flight Crew Alerting System

Alerts are categorized into 3 categories which are prioritized by the urgency of the required pilot response. Each of these use alert colors that are consistent with industry standards and requirements:

- Time critical warnings (red)
- Warnings alert (red)
- Cautions alert (amber)

Refer to Chapter 1, Flight Deck Philosophy and Operational Philosophy, which further explains key elements of flight deck design and prioritization of flight deck alerts.

Detection of Flight Crew Alerts

In all situations, the flight crew should review all flight deck alerts and analyze the situation in order to determine the appropriate course of action. This is especially important in situations with multiple alerts. Flight deck alerts are located on the:

- Forward and aisle stand panels
- Overhead panels
- Aft electronic panel

The Master Fire Warning lights and Master Caution lights do not indicate these alerts are higher priority than other warning or caution alerts respectively. The function of the Master Fire Warning Lights and Master Caution lights are to provide crew awareness to alerts not located in the forward field of view, i.e., not on the forward or aisle stand panels. After completing a NNC, the flight crew should review all warning lights, caution lights and other alerts to determine the need to do other NNCs.

Examples of Non-Normal Situations

In order to provide clear structure on flight crew response to non-normal situations, several structured examples are provided. A thorough understanding of Boeing's Flight Deck Philosophy is important in order to ensure a successful outcome to any non-normal situation. Refer to Chapter 1, Flight Deck Philosophy and Operational Philosophy, which further explains key elements of flight deck design and prioritization of flight deck alerts. In addition, refer to FCOM Volume 2, Chapter 15, Warning Systems for a thorough description of the alerting system.

A non-normal situation can be presented to the flight crew in several ways:

- annunciated by an aural warning and visual alert (time critical warning). Refer to the QRH Maneuvers Chapter. Examples include:
 - WINDSHEAR
 - TCAS
- annunciated by a warning light, warning bell and fire warning (warning alert). Examples include:
 - WHEEL WELL fire
 - Engine Fire
- annunciated by a caution light, master caution lights and associated system annunciator light (caution alert). Examples include:
 - SPEED TRIM FAIL
 - DRIVE
- annunciated only by a warning or caution light or alert. Examples include:
 - STAB OUT OF TRIM
 - AOA DISAGREE
- unannunciated - without light, alert, master caution, fire warning or aural alert. Examples include:
 - Airspeed Unreliable
 - Runaway Stabilizer
- combination resulting in multiple alerts.

After recognizing the situation, announcing the alert and recognition from the other pilot, the following sequence of crew actions are recommended for handling of the non-normal situation. These recommendations do not prevent an operator from developing equivalent techniques with appropriate regulatory approval. Some situations may require the Captain to assume control of the airplane, but many non-normal situations are managed more effectively if the Captain is the pilot monitoring.

737 NG Flight Crew Training Manual
Non-Normal Situation Guidelines Overview

This is a general overview of how non-normal situations should be conducted.

Consider maximum use of autoflight system to reduce workload, if available and appropriate. If flight directors are selected on, ensure the proper flight director modes are selected.

Pilot Flying	Pilot Monitoring
Recognizes and announces the non-normal situation. Other pilot acknowledges.	
MAINTAIN AIRPLANE CONTROL Ensure that the flight path is under control.	Monitor the flight path.
	ANALYZE THE SITUATION Review all warning lights, caution lights and other alert lights to identify the non-normal situation. Prioritize alerts and recommend course of action.
Acknowledges and confirms the Pilot Monitoring's identification or recommendation.	
TAKE THE PROPER ACTION Do the NNC memory items based on each crewmember's area of responsibility.	
Call for the appropriate NNC.	
	Completes the NNC.
Review all warning lights, caution lights and other alerts, and do other NNCs as needed.	
EVALUATE THE NEED TO LAND Review options for diversion or continued flight.	



Non-Normal Situation Annunciated by a Light and Fire Warning

This example illustrates the FIRE WARN lights illuminate due to an engine fire on the number 1 engine.

Pilot Flying	Pilot Monitoring
Recognizes and announces the non-normal situation. Other pilot acknowledges.	
	Identifies and announces illumination of the Engine Fire Switch for the number 1 engine.
Acknowledges the Pilot Monitoring.	
	Cancels the FIRE WARN lights after the Pilot Flying has acknowledged it.
Complete the ENGINE FIRE NNC memory items based on each crewmember's area of responsibility.	
Calls for the ENGINE FIRE NNC.	
	Completes the ENGINE FIRE NNC.
Review all warning lights, caution lights and other alerts, and do other NNCs as needed.	
<p>Note: After reviewing all caution lights, the flight crew determines that the DRIVE light illuminated after the number 1 engine was shutdown. Since the DRIVE light is the result of shutting down the number 1 engine, it is therefore not necessary to do the DRIVE NNC. This determination is made by the flight crew assessing the situation and determining the cause of the non-normal situation.</p>	

737 NG Flight Crew Training Manual
Non-Normal Situation Annunciated by a Light and Master Caution

This example illustrates the MASTER CAUTION lights illuminate due to an amber SPEED TRIM FAIL light.

Pilot Flying	Pilot Monitoring
Recognizes and announces the non-normal situation. Other pilot acknowledges.	
	Identifies and announces the FLT CONT light on the System Annunciator panel.
	Identifies and announces the SPEED TRIM FAIL light on the overhead panel.
Acknowledges the Pilot Monitoring.	
	Cancels the MASTER CAUTION lights after the Pilot Flying has acknowledged it.
Calls for the SPEED TRIM FAIL NNC.	
	Completes the SPEED TRIM FAIL NNC.
Review all warning lights, caution lights and other alerts, and do other NNCs as needed.	



Non-Normal Situation Annunciated by Light or Alert (without Master Caution or Fire Warning)

This example illustrates illumination of the STAB OUT OF TRIM light.

Pilot Flying	Pilot Monitoring
Recognizes and announces the non-normal situation. Other pilot acknowledges.	
Calls for the Stabilizer Out Of Trim NNC.	
	Completes the Stabilizer Out Of Trim NNC.
Review all warning lights, caution lights and other alerts, and do other NNCs as needed.	

UNCONTROLLED
IF PRINTED

737 NG Flight Crew Training Manual**Non-Normal Situation Unannounced**

This example illustrates a stabilizer runaway condition.

Pilot Flying	Pilot Monitoring
Recognizes and announces the non-normal situation. Other pilot acknowledges.	
Complete the Runaway Stabilizer NNC memory items based on each crewmember's area of responsibility.	
Calls for the Runaway Stabilizer NNC.	
	Completes the Runaway Stabilizer NNC.
Review all warning lights, caution lights and other alerts, and do other NNCs as needed.	

UNCONTROLLED
IF PRINTED

Non-Normal Situation with Multiple Alerts

It is possible to have multiple alerts associated with some non-normal situations. This example illustrates a flight crew recognizes an unreliable airspeed condition, completes the NNC and analyzes the need to do additional NNCs.

Pilot Flying	Pilot Monitoring
Recognizes and announces the non-normal situation. Other pilot acknowledges.	
Complete the Airspeed Unreliable NNC memory items based on each crewmember's area of responsibility.	
Calls for the Airspeed Unreliable NNC.	
	Completes the Airspeed Unreliable NNC.
Review all warning lights, caution lights and other alerts, and do other NNCs as needed.	
Recognizes and calls out the ALT DISAGREE alert. Other pilot acknowledges.	
Note: By analyzing the situation the flight crew determines the need to do the ALT DISAGREE NNC.	

It is possible to have a single malfunction that results in multiple flight deck indications. An additional example is an engine failure which results in an amber DRIVE light on the overhead panel along with MASTER CAUTION and ELEC system annunciator lights. By analyzing the situation and relying on system knowledge, the flight crew is expected to first do the Engine Failure or Shutdown NNC. After completing the NNC and reviewing other caution lights, the flight crew can determine that illumination of the DRIVE light is a result of the engine failure, and it is therefore not necessary to do the DRIVE NNC. In the event of such multiple flight deck indications, it is important for the flight crew to assess the situation to determine the cause of the non-normal situation. This allows the flight crew to prioritize alerts and complete the appropriate non-normal checklist.

Prioritization of Alerts and Non-Normal Checklists

The flight crew should consider the following in order to prioritize alerts and non-normal checklists:

- Doing NNCs with memory steps first
- Take action based on order of priority: time critical, warning or caution
- System knowledge

Troubleshooting

Troubleshooting can be defined as:

- taking steps beyond a published NNC in an effort to improve or correct a non-normal condition
- initiating an annunciated checklist without a light, alert, or other indication to improve or correct a perceived non-normal condition
- initiating diagnostic actions.

Examples of troubleshooting are:

- attempting to reset a system by cycling a system control or circuit breaker when not directed by the NNC
- using maintenance-level information to diagnose or take action
- using switches or controls intended only for maintenance.

Troubleshooting beyond checklist directed actions is rarely helpful and has caused further loss of system function or failure. In some cases, accidents and incidents have resulted. The crew should consider additional actions beyond the checklist only when completion of the published checklist steps clearly results in an unacceptable situation. In the case of airplane controllability problems when a safe landing is considered unlikely, airplane handling evaluations with gear, flaps or speedbrakes extended may be appropriate. In the case of jammed flight controls, do not attempt troubleshooting beyond the actions directed in the NNC unless the airplane cannot be safely landed with the existing condition. Always comply with NNC actions to the extent possible.

Crew distraction, caused by preoccupation with troubleshooting, has been a key factor in several fuel starvation and CFIT accidents. Boeing recommends completion of the NNC as published whenever possible, in particular for flight control malfunctions that are addressed by a NNC. Guidance for situations beyond the scope of the non-normal checklist is provided later in this chapter.

Approach and Landing

When a non-normal situation occurs, a rushed approach can often complicate the situation. Unless circumstances require an immediate landing, complete all corrective actions before beginning the final approach.

For some non-normal situations, the possibility of higher airspeed on approach, longer landing distance, a different flare profile or a different landing technique should be considered.

Plan an extended straight-in approach with time allocated for the completion of any lengthy NNC steps such as the use of alternate flap or landing gear extension systems. Arm autobrakes and speedbrakes unless precluded by the NNC.

Note: The use of autobrakes is recommended because maximum autobraking may be more effective than maximum manual braking due to timely application upon touchdown and symmetrical braking. However, the Advisory Information in the PI chapter of the QRH includes Non-Normal Configuration Landing Distance data specific to the use of maximum manual braking. When used properly, maximum manual braking provides the shortest stopping distance.

Fly a normal glide path and attempt to land in the normal touchdown zone. After landing, use available deceleration measures to bring the airplane to a complete stop on the runway. The captain must determine if an immediate evacuation should be accomplished or if the airplane can be safely taxied off the runway.

Landing at the Nearest Suitable Airport

Appendix A.2.12

“Plan to land at the nearest suitable airport” is a phrase used in the QRH. This section explains the basis for that statement and how it is applied.

In a non-normal situation, the pilot-in-command, having the authority and responsibility for operation and safety of the flight, must make the decision to continue the flight as planned or divert. In an emergency situation, this authority may include necessary deviations from any regulation to meet the emergency. In all cases, the pilot-in-command is expected to take a safe course of action.

The QRH assists flight crews in the decision making process by indicating those situations where “landing at the nearest suitable airport” is required. These situations are described in the Checklist Instructions or the individual NNC.

The regulations regarding an engine failure are specific. Most regulatory agencies specify that the pilot-in-command of a twin engine airplane that has an engine failure or engine shutdown should land at the nearest suitable airport at which a safe landing can be made.

737 NG Flight Crew Training Manual

A suitable airport is defined by the operating authority for the operator based on guidance material but, in general, must have adequate facilities and meet certain minimum weather and field conditions. If required to divert to the nearest suitable airport, the guidance material typically specifies that the pilot should select the nearest suitable airport “in point of time” or “in terms of time.” In selecting the nearest suitable airport, the pilot-in-command should consider the suitability of nearby airports in terms of facilities and weather and their proximity to the airplane position. The pilot-in-command may determine, based on the nature of the situation and an examination of the relevant factors, that the safest course of action is to divert to a more distant airport than the nearest airport. For example, there is not necessarily a requirement to spiral down to the airport nearest the airplane's present position if, in the judgment of the pilot-in-command, it would require equal or less time to continue to another nearby airport.

For persistent smoke or a fire which cannot positively be confirmed to be completely extinguished, the safest course of action typically requires the earliest possible descent, landing and evacuation. This may dictate landing at the nearest airport appropriate for the airplane type, rather than at the nearest suitable airport normally used for the route segment where the incident occurs.

Air Systems

Cabin Altitude Warning

There have been several reports of cabin altitude warning alerts caused by improperly configured engine bleed air and air conditioning pack switches. This condition is often the result of crews failing to reconfigure switches following a no engine bleed takeoff. Additionally, there have been reports of crews delaying their response to the cabin altitude warning alert because it was confused with the takeoff configuration warning horn.

In order to address the problem of incorrectly positioning switches that affect pressurization, the normal takeoff procedure directs the crew to set or verify the correct position of the engine bleed air and air conditioning pack switches after flap retraction is complete. Engine bleeds and air conditioning packs have also been included as specific items in the After Takeoff normal checklist.

Additionally, when doing a no engine bleed takeoff, reference to the No Engine Bleed Takeoff supplementary procedure, in conjunction with good crew coordination, reduces the possibility of crew errors.

On airplanes without the takeoff configuration and cabin altitude warning lights installed, confusion sometimes occurs between the cabin altitude warning horn and the takeoff configuration warning horn. This confusion can be resolved if the crew remembers that the takeoff configuration warning horn is only armed when the airplane is on the ground to indicate that the takeoff configuration is not correct for takeoff. If this horn is activated in flight, it indicates that the cabin altitude has reached 10,000 feet. In this case, the crew should immediately initiate the CABIN ALTITUDE WARNING or Rapid Depressurization NNC.

On airplanes with the takeoff configuration and cabin altitude warning lights installed, the TAKEOFF CONFIG light illuminates on the ground, when the takeoff configuration is not correct for takeoff. In flight, the CABIN ALTITUDE light illuminates when the cabin altitude is at or above 10,000 feet. In this case, the crew should immediately initiate the CABIN ALTITUDE WARNING or Rapid Depressurization NNC.

Ditching

Send Distress Signals

Transmit Mayday, current position, course, speed, altitude, situation, intention, time and position of intended touchdown, and type of airplane using existing air-to-ground frequency. Set transponder code 7700 and, if practical, determine the course to the nearest ship or landfall.

Advise Crew and Passengers

Alert the crew and the passengers to prepare for ditching. Assign life raft positions (as installed) and order all loose equipment in the airplane secured. Put on life vests, shoulder harnesses, and seat belts. Do not inflate life vests until after exiting the airplane.

Fuel Burn-Off

Consider burning off fuel prior to ditching, if the situation permits. This provides greater buoyancy and a lower approach speed. However, do not reduce fuel to a critical amount, as ditching with engine thrust available improves ability to properly control touchdown.

Passenger Cabin Preparation

Confer with cabin personnel either by interphone or by having them report to the flight deck in person to ensure passenger cabin preparations for ditching are complete.

Ditching Final

Transmit final position. Select flaps 40 or landing flaps appropriate for the existing conditions.

737 NG Flight Crew Training Manual

Advise the cabin crew of imminent touchdown. On final approach announce ditching is imminent and advise crew and passengers to brace for impact. Maintain airspeed at VREF. Maintain 200 to 300 fpm rate of descent. To accomplish the flare and touchdown, rotate smoothly to touchdown attitude of 10° to 12°. Maintain airspeed and rate of descent with thrust.

Initiate Evacuation

After the airplane has come to rest, proceed to assigned ditching stations and deploy slides/rafts. Evacuate as soon as possible, ensuring all passengers are out of the airplane.

Note: Be careful not to rip or puncture the slides/rafts. Avoid drifting into or under parts of the airplane. Remain clear of fuel-saturated water.

Engines, APU**Engine Oil System Indications**

Oil pressure is considered as the most significant of several oil system indicators. Oil temperature, oil quantity and oil pressure indications enable the flight crew to recognize a deteriorating oil system. While engine operation is governed by both oil pressure and oil temperature limits, there is no minimum oil quantity limit. Therefore, there is no low oil quantity NNC in the QRH.

If abnormal oil quantity indications are observed, check oil pressure and oil temperature. If oil pressure and oil temperature indications are normal, operate the engine normally. Accomplish the appropriate NNC for any non-normal oil pressure or oil temperature indications.

Engine Failure versus Engine Fire After Takeoff

The NNC for an engine failure is normally accomplished after the flaps have been retracted and conditions permit.

In case of an engine fire, when the flight path is under control, the gear has been retracted, and a safe altitude has been attained (minimum 400 feet AGL) accomplish the NNC memory items. Due to asymmetric thrust considerations, Boeing recommends that the PF retard the affected thrust lever after the PM confirms that the PF has identified the correct engine. Reference items should be accomplished by the PM as soon as practical.

Engine Tailpipe Fire

An engine tailpipe fire can occur while on the ground, during engine start or shutdown. Since a tailpipe fire develops in an area of the engine without fire detection capability, the engine fire warning will not show.

Communication with a trained ground crew member via the flight interphone or hand signals can provide awareness of a tailpipe fire. Reports of a tailpipe fire may also be received from ATC, cabin crew, or flight crew members of nearby airplanes.

Engine tailpipe fires can occur due to the following:

- engine control malfunction
- excess fuel in the combustor, turbine or exhaust nozzle
- oil accumulation in the hot section flow path or exhaust system.

If a tailpipe fire is reported, the crew should accomplish the NNC without delay. Flight crews should consider the following when dealing with this situation:

- motoring the engine is the primary means of extinguishing the fire
- to prevent an inappropriate evacuation, flight attendants should be notified without significant delay
- communications with ramp personnel and the tower are important to determine the status of the tailpipe fire and to request fire extinguishing assistance
- the engine fire checklist is inappropriate because the engine fire extinguishing agent is not effective against a fire inside the tailpipe.

Loss of Engine Thrust Control

All turbo fan engines are susceptible to this malfunction whether engine control is hydro-mechanical, hydro-mechanical with supervisory electronics (e.g. PMC) or Full Authority Digital Engine Control (FADEC). Engine response to a loss of control varies from engine to engine. Malfunctions have occurred in-flight and on the ground. The major challenge the flight crew faces when responding to this malfunction is recognizing the condition and determining which engine has malfunctioned. The Engine Limit or Surge or Stall NNC is written to include this malfunction. This condition can occur during any phase of flight.

Failure of engine or fuel control system components or loss of thrust lever position feedback has caused loss of engine thrust control. Control loss may not be immediately evident since many engines fail to some fixed RPM or thrust lever condition. This fixed RPM or thrust lever condition may be very near the commanded thrust level and therefore difficult to recognize until the flight crew attempts to change thrust with the thrust lever. Other engine responses include: shutdown, operation at low RPM, or thrust at the last valid thrust lever setting (in the case of a thrust lever feedback fault) depending on altitude or air/ground logic. In all cases, the affected engine does not respond to thrust lever movement or the response is abnormal.

737 NG Flight Crew Training Manual

Since recognition may be difficult, if a loss of engine control is suspected, the flight crew should continue the takeoff or remain airborne until the NNC can be accomplished. This helps with directional control and may preclude an inadvertent shutdown of the wrong engine. In some conditions, such as during low speed ground operations, immediate engine shutdown may be necessary to maintain directional control.

Loss of Thrust on Both Engines

Dual engine failure is a situation that demands prompt action regardless of altitude or airspeed. Accomplish memory items and establish the appropriate airspeed to immediately attempt a windmill restart. There is a higher probability that a windmill start will succeed if the restart attempt is made as soon as possible (or immediately after recognizing an engine failure) to take advantage of high engine RPM. Establishing airspeeds above the crossbleed start envelope and altitudes below 30,000 feet improves the probability of a restart. Loss of thrust at higher altitudes may require descent to a lower altitude to improve windmill starting capability.

The in-flight start envelope defines the region where windmill starts were demonstrated during certification. It should be noted that this envelope does not define the only areas where a windmill start may be successful. The LOSS OF THRUST ON BOTH ENGINES NNC is written to ensure that flight crews take advantage of the high RPM at engine failure regardless of altitude or airspeed. Initiate the memory portion of the LOSS OF THRUST ON BOTH ENGINES NNC before attempting an APU start for the reasons identified above. If the windmill restart is not successful, an APU start should be initiated as soon as practical to provide electrical power and starter assist during follow-on engine start attempts.

During in-flight restart attempts use the lower of the EGT redline and the EGT start limit redline, if displayed. A hung or stalled in-flight start is normally indicated by stagnant RPM and increasing EGT. During start, engines may accelerate to idle slowly but action should not be taken if RPM is increasing and EGT is not near or rapidly approaching the limit.

Note: When electrical power is restored, do not confuse the establishment of APU generator power with the establishment of engine generator power at idle RPM and advance the thrust lever prematurely.

Airframe Vibration Due to Engine Severe Damage or Separation

Certain engine failures, such as fan blade separation can cause high levels of airframe vibration. Although the airframe vibration may seem severe to the flight crew, it is extremely unlikely that the vibration will damage the airplane structure or critical systems. However, the vibration should be reduced as soon as possible by reducing airspeed and descending. In general, as airspeed decreases vibration levels decrease. As airspeed or altitude change the airplane can transition through various levels of vibration. It should be noted that the vibration may not completely stop.

If vibration remains unacceptable, descending to a lower altitude (terrain permitting) allows a lower airspeed and normally lower vibration levels. Vibration will likely become imperceptible as airspeed is further reduced during approach.

The impact of a vibrating environment on human performance is dependent on a number of factors, including the orientation of the vibration relative to the body. People working in a vibrating environment may find relief by leaning forward or backward, standing, or otherwise changing their body position.

Once airframe vibration has been reduced to acceptable levels, the crew must evaluate the situation and determine a new course of action based on weather, fuel remaining, and available airports.

Recommended Technique for an In-Flight Engine Shutdown

[Appendix A.2.12](#)

Any time an engine shutdown is needed in flight, good crew coordination is essential. Airplane incidents have turned into airplane accidents as a result of the flight crew shutting down the incorrect engine.

When the flight path is under complete control, the crew should proceed with a deliberate, systematic process that identifies the affected engine and ensures that the operating engine is not shut down. Do not rush through the shutdown checklist, even for a fire indication. The following technique is an example that could be used:

When an engine shutdown is needed, the PF disconnects the A/T. The PF then verbally coordinates confirmation of the affected engine with the PM and then slowly retards the thrust lever of the engine that will be shutdown.

Coordinate activation of the start lever as follows:

- PM places a hand on and verbally identifies the start lever for the engine that will be shutdown
- PF verbally confirms that the PM has identified the correct start lever
- PM moves the start lever to cutoff.

737 NG Flight Crew Training Manual

If the NNC requires activation of the engine fire switch, coordinate as follows:

- PM places a hand on and verbally identifies the engine fire switch for the engine that is shutdown
- PF verbally confirms that the PM has identified the correct engine fire switch
- PM pulls the engine fire switch.

Bird Strikes

Experience shows that bird strikes are common in aviation. Most bird strikes occur at very low altitudes, below 500 feet AGL. This section deals with bird strikes that affect the engines.

Recent studies of engine bird strikes reveal that approximately 50% of engine bird strikes damage the engine(s). The risk of engine damage increases proportionally with the size of the bird and with increased engine thrust settings. When an engine bird strike damages the engine, the most common indications are significant vibrations due to fan blade damage and an EGT increase.

Note: After any bird strike, the engines should be inspected by maintenance.

Preventative Strategies

Airports are responsible for bird control and should provide adequate wildlife control measures. If large birds or flocks of birds are reported or observed near the runway, the crew should consider:

- delaying the takeoff or landing when fuel permits. Advise the tower and wait for airport action before continuing
- takeoff or land on another runway that is free of bird activity, if available.

To prevent or reduce the consequences of a bird strike, the crew should:

- discuss bird strikes during takeoff and approach briefings when operating at airports with known or suspected bird activity.
- be extremely vigilant if birds are reported on final approach
- if birds are expected on final approach, plan additional landing distance to account for the possibility of no thrust reverser use if a bird strike occurs.

Note: The use of weather radar to scare the birds has not been proven effective.

Crew Actions for a Bird Strike During Takeoff

If a bird strike occurs during takeoff, the decision to continue or reject the takeoff is made using the criteria found in the Rejected Takeoff maneuver of the QRH.

If a bird strike occurs above 80 knots and prior to V₁, and there is no immediate evidence of engine failure (e.g. failure, fire, power loss, or surge/stall), the preferred option is to continue with the take off followed by an immediate return, if required.

Crew Actions for a Bird Strike During Approach or Landing

If the landing is assured, continuing the approach to landing is the preferred option. If more birds are encountered, fly through the bird flock and land. Maintain as low a thrust setting as possible.

If engine ingestion is suspected, limit reverse thrust on landing to the amount needed to stop on the runway. Reverse thrust may increase engine damage, especially when engine vibration or high EGT is indicated.

Evacuation

If an evacuation is planned and time permits, a thorough briefing and preparation of the crew and passengers improves the chances of a successful evacuation. Flight deck preparations should include a review of pertinent checklists and any other actions to be accomplished. Appropriate use of autobrakes should be discussed. If evacuating due to fire in windy conditions, consider positioning the airplane so the fire is on the downwind side.

Notify cabin crew of possible adverse conditions at the affected exits. The availability of various exits may differ for each situation. Crewmembers must make the decision as to which exits are usable for the circumstances.

For unplanned evacuations, the captain needs to analyze the situation carefully before initiating an evacuation order. Quick actions in a calm and methodical manner improve the chances of a successful evacuation.

Method of Evacuation

When there is a need to evacuate passengers and crew, the captain has to choose between commanding an emergency evacuation using the emergency escape slides or less urgent means such as deplaning using stairs, jetways, or other means. All available sources of information should be used to determine the safest course of action including reports from the cabin crew, other airplanes, and air traffic control. The captain must then determine the best means of evacuation by carefully considering all factors. These include, but are not limited to:

- the urgency of the situation, including the possibility of significant injury or loss of life if a significant delay occurs
- the type of threat to the airplane, including structural damage, fire, reported bomb on board, etc.
- the possibility of fire spreading rapidly from spilled fuel or other flammable materials

737 NG Flight Crew Training Manual

- the extent of damage to the airplane
- the possibility of passenger injury during an emergency evacuation using the escape slides.

If in doubt, the crew should consider an emergency evacuation using the escape slides.

If there is a need to deplane passengers, but circumstances are not urgent and the captain determines that the Evacuation NNC is not needed, the normal shutdown procedure should be completed before deplaning the passengers.

Discharging Fire Bottles During an Evacuation

The evacuation NNC specifies discharge of an engine or APU fire bottle if an engine or APU fire warning light is illuminated. However, evacuation situations can present possibilities regarding the potential for fire that are beyond the scope of the NNC and may not activate an engine or APU fire warning. The crew should consider the following when deciding whether to discharge a fire bottle into an engine and/or APU:

- if an engine fire indication exists or a fire is reported in or near an engine, discharge a fire bottle into the affected engine
- if an APU fire indication exists or a fire is reported in or near the APU, discharge the APU bottle
- the discharged halon agent is designed to extinguish a fire and has very little or no fire prevention capability in the engine nacelles. Halon dissipates quickly into the atmosphere
- there is no reason to discharge the engine or APU fire bottles for evacuations not involving fire indications existing or reported in or near an engine or APU, e.g., cargo fire, security or bomb threat, etc.

Flight Controls

Leading Edge or Trailing Edge Device Malfunctions

Leading edge or trailing edge device malfunctions can occur during extension or retraction. This section discusses all flaps up and partial or asymmetrical leading/trailing edge device malfunctions for landings.

Note:

All Flaps Up Landing

The probability of both leading and trailing edge devices failing to extend is extremely remote. Training and evaluating to this condition is not required. An All Flaps Up Landing NNC is in the QRH for this condition. If a flaps up and slats up landing situation were to be encountered in service, the pilot should consider the following techniques.

After selecting a suitable landing airfield and prior to beginning the approach, consider reduction of airplane gross weight (burn off fuel) to reduce touchdown speed.

Fly a wide pattern to allow for the increased turning radius required for the higher maneuver speed. Establish final approximately 10 NM from the runway. This allows time to extend the gear and decelerate to the target speed while in level flight and complete all required checklists. Maintain no slower than flaps up maneuver speed until established on final. Maneuver with normal bank angles until on final.

Final Approach

Use an ILS or GLS glide slope if available. Do not reduce the airspeed to the final approach speed until aligned with the final approach. Before intercepting the descent profile, decrease airspeed to command speed and maintain this speed until the landing is assured.

The normal rate of descent on final is approximately 900 fpm due to the higher ground speed. Final approach body attitude is approximately 1° - 2° higher than a flaps 30 approach. Do not make a flat approach (shallow glide path angle) or aim for the threshold of the runway. Use a normal aim point approximately 1,000 feet down the runway.

Note: Use of the autopilot during approach phase is acceptable. Do not autoland.

Speedbrakes are not recommended for airspeed reduction below 800 feet. If landing is anticipated beyond the normal touch down zone, go around.

Landing

Fly the airplane onto the runway at the recommended touchdown point. Flare only enough to achieve an acceptable reduction in the rate of descent. Do not allow the airplane to float. Floating just above the runway surface to deplete additional speed wastes available runway and increases the possibility of a tail strike. Do not risk touchdown beyond the normal touchdown zone in an effort to achieve a smooth landing.

Slight forward pressure on the control column may be needed to achieve touchdown at the desired point and to lower the nose wheels to the runway. After lowering the nose wheels to the runway, hold light forward control column pressure and expeditiously accomplish the landing roll procedure.

Immediate initiation of reverse thrust at main gear touchdown (reverse thrust is more effective at high speeds) and full reverse thrust allows the autobrake system to reduce brake pressure to the minimum level. Full reverse thrust is needed for a longer period of time. Less than maximum reverse thrust increases brake energy requirements and may result in excessive brake temperatures.

737 NG Flight Crew Training Manual

Use of autobrakes is recommended. Autobrake setting should be consistent with runway length. Use manual braking if deceleration is not suitable for the desired stopping distance.

Leading Edge Flaps Transit - Landing

If an asymmetrical or skewed leading edge device condition occurs, use the LEADING EDGE FLAPS TRANSIT NNC to determine the flap setting and VREF for approach. VREF provides 15° bank angle maneuver capability and allows for 15° overshoot protection in all cases.

Do not hold the airplane off during landing flare. Floating just above the runway surface to deplete the additional threshold speed wastes available runway and increases the possibility of a tail strike.

Note: If the gear is retracted during a go-around and flap position is greater than 25, a landing gear configuration warning occurs.

Trailing Edge Flap Asymmetry - Landing

If a trailing edge flap asymmetry occurs, full maneuver capability exists even if the asymmetry occurred at flaps just out of the full up position. Burn off fuel to reduce landing weight and lower approach speed.

Fly accurate airspeeds in the landing pattern. At lesser flap settings, excess airspeed is difficult to dissipate, especially when descending on final approach. Pitch attitude and rate of descent on final is higher than for a normal landing. During flare, airspeed does not bleed off as rapidly as normal.

Fly the airplane onto the runway at the recommended touchdown point. Flare only enough to achieve an acceptable reduction in the rate of descent. Do not allow the airplane to float. Floating just above the runway surface to deplete additional speed wastes available runway and increases the possibility of a tail strike. Do not risk touchdown beyond the normal touchdown zone in an effort to achieve a smooth landing.

Note: If the gear is retracted during a go-around and flap position is greater than 25, a landing gear configuration warning occurs.

Flap Extension using the Alternate System

When extending the flaps using the alternate system, the recommended method for setting command speed differs from the method used during normal flap extension. Since the flaps extend more slowly when using the alternate system, it is recommended that the crew delay setting the new command speed until the flaps reach the selected position. This method may prevent the crew from inadvertently getting into a low airspeed condition if attention to airspeed is diverted while accomplishing other duties.

Jammed or Restricted Flight Controls

The flight control system consists of control surfaces mechanically linked to flight deck controls.

Although rare, jamming of the flight control system has occurred on commercial airplanes. A jammed flight control can result from ice accumulation due to water leaks onto cables or components, dirt accumulation, component failure such as cable break or worn parts, improper lubrication, or foreign objects.

A flight control jam may be difficult to recognize, especially in a properly trimmed airplane.

A flight control jam in the pitch axis may be difficult to recognize. In the case of the elevator, the jammed control can be masked by trim. Some indications of an elevator jam are:

- unexplained autopilot disengagement
- autopilot that cannot be engaged
- undershoot or overshoot of an altitude during autopilot level-off
- higher than normal control forces required during speed or configuration changes.

Uncommanded roll may result from lateral control surface jams. Lateral control surface jams may not result in restricted movement of the control wheel but will require control wheel input to trim.

If any jammed flight control condition exists, refer to the Jammed or Restricted Flight Controls NNC.

Both pilots should apply force to try to either clear the jam or activate the override feature. There should be no concern about damaging the flight control mechanism by applying too much force to either clear a jammed flight control or activate an override feature. Maximum force may result in some flight control surface movement with a jammed flight control. If the jam clears, both pilot's flight controls are available.

Note: If a control is jammed due to ice accumulation, the jam may clear when moving to a warmer temperature.

Note: There are override features for the control wheel and the control column.

737 NG Flight Crew Training Manual

If the jam does not clear, activation of an override feature allows a flight control surface to be moved independent of the jammed control. Applying force to the non-jammed flight control activates the override feature. When enough force is applied, the jammed control is overridden allowing the non-jammed control to operate. To identify the non-jammed flight control, apply force to each flight control individually. The flight control that results in the greatest airplane control is the non-jammed control.

Note: The pilot of the non-jammed control should be the pilot flying for the remainder of the flight.

The non-jammed control requires a normal force, plus an additional override force to move the flight control surface. For example, if a force of 10 lbs (4 kgs) is normally needed to move the surface, and 50 lbs (23 kgs) of force is needed to activate the override, a total force of 60 lbs (27 kgs) is needed to move the control surface while in override. Response is slower than normal with a jammed flight control; however, sufficient response is available for airplane control and landing.

For those controls without override features, limited flight control surface deflection occurs when considerable force is applied to the flight control. This response is due to cable stretch and structural bending. This response may be sufficient for airplane control and landing.

Trim Inputs

If a jammed flight control condition exists, use manual inputs from other control surfaces to counter pressures and maintain a neutral flight control condition. The following table provides trim inputs that may be used to counter jammed flight control conditions.

Jammed Control Surface	Manual Trim Inputs
Elevator	Stabilizer
Aileron	Rudder*
Rudder	Aileron
Spoiler	Rudder*, Aileron
*See Recommended Rudder Trim Technique, Chapter. 1	

Note: Asymmetric engine thrust may aid roll and directional control.

Approach and Landing

Attempt to select a runway with minimum crosswind. Complete approach preparations early. Recheck flight control surface operation prior to landing to determine if the malfunction still exists. Do not make abrupt thrust, speedbrake, or configuration changes. Make small bank angle changes. Establish landing configuration, correct airspeed and in-trim condition early on final approach. Establish touchdown attitude no later than crossing the threshold and do not reduce thrust to idle until after touchdown. Above maximum landing weight, some stabilizer trim is needed to assist in the flare if the elevator is jammed. Asymmetrical braking and asymmetrical thrust reverser deployment may aid directional control on the runway.

Note: In the event of an elevator jam, control forces will be significantly greater than normal and control response will be slower than normal to flare the airplane. Maintain flight path with thrust and main electric trim as needed.

Go Around Procedure

If the elevator is known or suspected to be jammed, a go-around should be avoided if at all possible. To execute a go-around with a jammed elevator, slowly and smoothly advance thrust levers while maintaining pitch control with stabilizer and any available elevator. If a go-around is required, the go-around procedure is handled in the same manner as a normal go-around.

Stabilizer Trim Inoperative

The stabilizer trim may become inoperative for number of reasons. The most common reason is a failed stabilizer motor. This failure mode causes a loss of electric trim through both the autopilot and control wheel switches. Manual trim is still available with either trim wheel. This failure mode is addressed using the STABILIZER TRIM INOPERATIVE NNC.

Other, less common failure modes that are also addressed using the STABILIZER TRIM INOPERATIVE NNC include:

- a lodged or stuck stabilizer motor. This failure mode causes a loss of electric trim through both the autopilot and control wheel switches. Manual trim is still available with either trim wheel to override the jam. The effort needed to manually rotate the trim wheels in this condition is higher than normal
- a lodged or stuck stabilizer actuator. This failure mode causes a loss of electric trim through both the autopilot and control wheel switches and a loss of manual trim. The result is a stabilizer that cannot be trimmed. Flight tests have demonstrated the airplane can be flown and landed safely with stabilizer trim inoperative
 - a lodged or stuck stabilizer actuator can be the result of ice on the jackscrew. If the crew suspects that the failure could be due to ice accumulation, descend to a warmer temperature and try again.

Runaway Stabilizer

A runaway stabilizer condition can be recognized by continuous uncommanded movement of stabilizer trim, or if stabilizer trim is occurring in a manner that is not appropriate for current flight conditions. During manual flight or flight with the autopilot engaged, automatic stabilizer trim can be commanded by the Speed Trim System or autopilot trim. Since commanded stabilizer trim can occur automatically, the pilot needs to consider the existing flight conditions to determine if a runaway stabilizer condition exists. For example, some stabilizer trim movement can be expected to occur during speed, altitude, or configuration changes.

During a runaway stabilizer condition the crew should maintain airplane pitch control through the use of the control column, main electric stabilizer trim, and thrust levers. The control column must be held firmly before the autopilot (if engaged) is disengaged to maintain airplane pitch control and retain any elevator commands from the autopilot. After the autopilot and autothrottle are disengaged, use the control column and thrust levers to establish appropriate pitch attitude and airspeed. If uncommanded trim motion continues, it may stop when the control column is displaced in the opposite direction and the control column cutout is activated. Use main electric stabilizer trim to reverse any stabilizer trim movement and to reduce control column forces. Sustained use of main electric stabilizer trim may be needed. It is important to note that even though the steps in the Runaway Stabilizer checklist are sequential, these steps can be accomplished simultaneously. If uncommanded stabilizer trim movement continues, place both STAB TRIM cutout switches to the CUTOOUT position. Manual stabilizer trim should then be used for the remainder of the flight.

Manual Stabilizer Trim

During some non-normal conditions, manual stabilizer trim may be needed. The flight crew should use main electric stabilizer trim, if available, to ensure the airplane is in-trim prior to relying on the use of manual stabilizer trim. Manual stabilizer trim is intended for small corrections from an in-trim condition. If manual stabilizer trim is needed, make sure both STAB TRIM cutout switches are in the CUTOOUT position prior to extending the manual trim wheel handles. Anytime manual stabilizer trim is in use, keep the manual trim wheel handles extended. This allows easy access for the pilots to make required trim changes.

Note: Moving the STAB TRIM cutout switches to the CUTOOUT position can result in illumination of the SPEED TRIM FAIL light. This can occur during manual flight if the Speed Trim System determines a need to trim but the system is disabled.

The stabilizer trim wheels are installed so that the two handles are offset by 90 degrees. This offset improves leverage and allows both pilots to apply more force during manual trimming than if the handles were offset by 180 degrees. One unit of stabilizer trim requires approximately 15 turns of the stabilizer trim wheel.

Boeing flight tests and ergonomic evaluations demonstrated that a small stature, 5'2" pilot can manage the trim wheel forces throughout the normal flight envelope. In some corner conditions, a low force capable pilot may need to use two hands, either on one trim wheel handle or one hand on each trim wheel handle. Flight tests included both nominal and abuse cases for stabilizer mis-trims and determined that either a one or two pilot effort can be used to correct an out-of-trim condition and will not cause a cable or system failure. Reducing or controlling airspeed is the most effective way to decrease airloads on the stabilizer, which lowers the effort needed to trim manually.

When manually trimming the stabilizer, flight crew coordination is important. There are several techniques available for manually trimming. For example:

- The Pilot Flying can fly and trim
- The Pilot Monitoring can trim at the direction of the Pilot Flying
- Both pilots can trim at the same time
- The Pilot Monitoring can use one or both hands to trim

If high force is needed:

- Both pilots can trim at the same time
- The Pilot Monitoring can consider using one hand on each trim wheel handle to trim the airplane.

Consider stowing the inboard armrests for easier access to the trim wheel handles. Anticipate the trim requirements for airspeed and configuration changes. Configure the airplane and establish an in-trim condition early in the approach. If a go-around is required, anticipate any trim changes as airspeed increases.

Standby Rudder On

The STANDBY RUDDER ON light illuminates any time the standby rudder PCU is operating. If this light illuminates independent of crew action or a hydraulic system malfunction, either of two conditions may have occurred. The most probable cause is a force fight monitor malfunction inadvertently activating the standby pump and powering the standby PCU. In this case, three PCU control valves power the rudder and full rudder inputs should be avoided to prevent applying excessive loads on the rudder. The NNC is written for this condition. The second cause may be because of a pressure difference between the two main PCU control valves indicating a jammed condition. This condition does not require a NNC because satisfactory rudder operation is available using the standby rudder PCU.

Flight Instruments, Displays

Airspeed Unreliable

Unreliable airspeed indications can result due to erroneous data from the pitot/static system, AOA vanes, ADIRU, or damage to the radome.

Blockages or freezing in the pitot/static system can result in airspeed and altitude indications that are unreliable. This could mean increasing indicated airspeed in a climb, decreasing indicated airspeed in descent, or unpredictable indicated airspeed in cruise.

The following are potential causes of erroneous pitot/static system data:

- If the ram air inlet to the pitot head is blocked, pressure in the probe is released through the drain holes and the airspeed slowly drops to zero.
- If the ram air inlet and the probe drain holes are both blocked, pressure trapped within the system reacts unpredictably. The pressure may increase through expansion, decrease through contraction, or remain constant. In all cases, the airspeed indications would be abnormal.

Erroneous AOA data, often caused by damage to the AOA vane, can result in unreliable airspeed and altitude indications on the side with the erroneous AOA.

Increased reliance on automation has de-emphasized the practice of setting known pitch attitudes and thrust settings. However, if an unreliable airspeed condition occurs, the flight crew should be familiar with the approximate pitch attitude and thrust setting for each phase of flight. This familiarity can be gained by noting the pitch attitude and thrust setting occasionally during normal flight. Any significant change in pitch attitude from the attitude normally required to maintain a particular airspeed or Mach number should alert the flight crew to a potential airspeed problem.

If abnormal airspeed indications are recognized, immediately set the target pitch attitude and thrust setting for the airplane configuration from the Airspeed Unreliable memory items. Once flight path is under control and the airplane is not in a critical phase of flight, accomplish the Airspeed Unreliable NNC. The crew should alert ATC if unable to maintain assigned altitude or if altitude indications are unreliable.

Early recognition of erroneous airspeed indications requires familiarity with the interrelationship of attitude, thrust setting, and airspeed. A delay in recognition could result in loss of airplane control.

Memory items for target pitch and thrust must be accomplished as soon as it is suspected that airspeed indications are incorrect. The intent of having memorized pitch and thrust settings is to quickly put the airplane in a safe regime until the Airspeed Unreliable checklist can be referenced. The following assumptions and requirements were used in developing these memory items:

- The memorized settings are calculated to work for all model/engine combinations, at all weights and at all altitudes.
- The flaps up settings will be sufficient such that the actual airspeed remains above stall and below overspeed.
- The flaps extended settings will be sufficient such that the actual airspeed remains above stall and below the flap placard limit.
- The settings are biased toward a higher airspeed as it is better to be at a high energy state than a low energy state.
- These memorized settings are to allow time to stabilize the airplane, remain within the flight envelope without overspeed or stall, and then continue with reference to the checklist.
- Settings are provided for flight with and without flaps extended. The crew should use the setting for the condition they are in to keep the airplane safe while accessing the checklist.

The memorized pitch and thrust setting for the current configuration (flaps extended/flaps up) should be applied immediately with the following considerations:

- The flaps extended pitch and thrust settings will result in a climb.
- The flaps up pitch and thrust settings will result in a slight climb at light weights and low altitudes, and a slight descent at heavy weights and high altitudes.
- At light weight and low altitude, the true airspeed will be higher than normal, but within the flight envelope. At heavy weight and high altitude, the same settings will result in airspeed lower than normal cruise but within the flight envelope.
- The goal of these pitch and thrust settings is to maintain the airplane safely within the flight envelope, not to maintain a specific climb or level flight.
- The current flap position should be maintained until the memory pitch and thrust settings have been set and the airplane stabilized. If further flap extension/flap retraction is required refer to PI-QRH Unreliable Airspeed table.

The following table provides pitch and thrust settings calculated to work for all model/engine combinations, at all weights and at all altitudes.

737 NG Flight Crew Training Manual

	Flaps Extended		Flaps Up	
Model	Pitch Attitude (degrees)	Thrust (N1)	Pitch Attitude (degrees)	Thrust (N1)
737	10	80	4	75

To determine if a reliable source of indicated airspeed is available, the flight crew should assess and compare flight deck indications, or use the Flight with Unreliable Airspeed tables in the QRH or other approved source.

There are several flight deck indications that can be present during an unreliable airspeed condition that can assist the flight crew to determine a reliable airspeed indication. If a reliable airspeed can be determined without referring to the Flight with Unreliable Airspeed tables in the QRH, the reliable airspeed source can be used for the remainder of the flight. It is important to emphasize that all of the flight deck indications need to be considered in order to accurately determine a reliable source of indicated airspeed. If a reliable source of indicated airspeed cannot be positively determined, refer to Flight with Unreliable Airspeed tables in the QRH. Possible erroneous flight deck indications that can assist the flight crew to determine a reliable airspeed indication are:

- Stick shaker activation on one side
- Airspeed low indications on one side
- Pitch Limit Indicator (PLI) on one side

Note: Comparing only two corresponding airspeeds is not a conclusive indication to determine a reliable airspeed indication. The two corresponding airspeeds can still both be unreliable.

If the flight crew suspects that the unreliable airspeed condition may be caused by erroneous AOA, in addition to the above flight deck indications, the AOA DISAGREE alert is shown on both PFDs and erroneous minimum and maximum speed bars are shown on one side. In this situation, comparing indicated airspeed on the PFDs with the ISFD can help the flight crew determine a reliable airspeed indication.

Ground speed information is available from the FMC and on the instrument displays. These indications can be used as a crosscheck. Many air traffic control radars can also measure ground speed.

During unreliable airspeed events caused by pitot/static problems, the Angle of Attack (AOA) indicator (as installed) can be referenced by increasing or reducing airspeed to maintain the analog needle at approximately the three o'clock position. This approximates a safe maneuver or approach speed regardless of flap position.

During unreliable airspeed events caused by erroneous AOA data, the properly operating AOA indicator (as installed) can be used as needed.

If by comparing flight deck indications the flight crew is not able to determine a reliable airspeed indication, the Airspeed Unreliable checklist says, "When in trim and stabilized, compare the captain, first officer, and standby airspeed indicators." The intent of this statement is for the pilot flying to set the pitch attitude and thrust setting from the PI-QRH Flight With Unreliable Airspeed tables and allow the airplane to stabilize before comparing the airspeed indications to those shown in the table.

The airplane is considered stabilized when the thrust and pitch have been set, and the pitch is trimmed with no further trim movement needed to maintain the pitch setting. This is not an instantaneous process, and must be complete before comparing indicated and expected airspeeds for accurate results.

If it is determined that none of the airspeed indicators are reliable, the PI-QRH tables should be used for the remainder of the flight. Flight crews need to ensure they are using the table and values appropriate for phase of flight and airplane configuration.

- When changing phase of flight or airplane configuration, make initial thrust change, set pitch attitude, configure the airplane as needed, then recheck thrust and pitch, and trim as needed. Do not change configuration until the airplane is trimmed and stabilized at the current configuration.

If the flight crew recognizes an unreliable airspeed condition and concludes that a reliable airspeed indication is not available, safe flight can still be conducted.

Takeoff

If an unreliable airspeed event occurs during takeoff at or after V₁, maintain takeoff thrust, set 15° pitch attitude, retract the landing gear, and maintain flap configuration. Climb at 15° pitch attitude until reaching acceleration height. At acceleration height, do the Airspeed Unreliable NNC memory items and checklist.

Descent

Idle thrust descents to 10,000 feet can be made by flying pitch attitude and checking rate of descent in the QRH/PI tables. At 2,000 feet above the selected level off altitude, reduce rate of descent to 1,000 FPM. On reaching the selected altitude, establish pitch and thrust for the airplane configuration. If possible, allow the airplane to stabilize before changing configuration and altitude.

Approach

If available, accomplish an ILS or GLS approach. Establish landing configuration early on final approach. At glide slope intercept or beginning of descent, set thrust and attitude per the QRH tables and control the rate of descent with thrust.

737 NG Flight Crew Training Manual

Landing

Control the final approach so as to touch down approximately 1,000 feet to 1,500 feet beyond the threshold. Fly the airplane on to the runway, do not hold it off or let it “float” to touchdown.

Use autobrakes if available. If manual braking is used, maintain adequate brake pedal pressure until a safe stop is assured. Immediately after touchdown, expeditiously accomplish the landing roll procedure.

Go-Around or Missed Approach - Airspeed Unreliable

In the event that either the Captain’s or First Officer’s airspeed indication is reliable, the flight directors on the reliable PFD can be used during an approach. When TO/GA is pushed in the event of a go-around or missed approach, pitch guidance may automatically be removed from view on both PFDs as a result of a disagreement between PFD flight director pitch guidance. Flight director roll guidance remains available.

Flight director pitch guidance returns to view on the reliable PFD when a pitch mode change is made or automatically occurs. Simultaneously, flight director roll guidance is automatically removed on the unreliable PFD.

Refer to the Flight With Airspeed Unreliable go-around table prior to starting the approach. This provides a target pitch setting in the event that flight director pitch guidance is removed.

Note: If the APP mode is used during the approach, it is important to exit the APP mode in the event of a go-around. This can be done by pushing TO/GA.

Note: If only the standby airspeed indication is reliable, do not use TO/GA.

Altitude Unreliable

Altitude information transmitted to ATC by the airplane’s transponder may be unreliable. ATC is not an independent source of barometric altitude information. In situations where altitude indications are unreliable or altimeters disagree, transponder altitude received by ATC may be unreliable and cannot be used to verify barometric altitude. Accomplish the ALT DISAGREE NNC if the alert is shown.

In the event of an unreliable altitude condition, it is important to note that GPWS DA/MDA callouts are provided based on the Captain’s minimum selector. If the Captain’s altitude indications are not reliable, then the minimums selector should not be set on the Captain’s side, as the DA/MDA aural callouts are inaccurate. If only the First Officer’s altitude indications are reliable, then the minimums selector can be set on the First Officer’s side; however, DA/MDA aural callouts are not provided.

Erroneous Angle of Attack (AOA) Indications

Damage to AOA vanes can occur for several reasons including bird strikes or impact during ramp operations.

An erroneous AOA can cause one or more of the following indications:

- AOA DISAGREE alert
- ALT DISAGREE alert
- IAS DISAGREE alert
- FEEL DIFF PRESS light (if EFS active for 30 continuous seconds)

One or more of the following flight deck effects can also occur:

- Airspeed low aural
- Autoslat operation
- Automatic disengagement of autopilot
- Inability to engage autopilot
- Windshear aural and indications

One or more of the following flight deck effects can also occur **on the affected side**:

- Airspeed low PFD indications
 - Continuous or intermittent stick shaker
 - Erroneous Flight Director (FD) pitch command bar
 - Erroneous Pitch Limit Indicator (PLI)
 - Erroneous minimum and maximum speed bars (red and black)
-

Fuel

Fuel Balance

The primary purpose of fuel balance limitations on Boeing airplanes is for the structural life of the airframe and landing gear and not for controllability. A reduction in structural life of the airframe or landing gear can be caused by frequently operating with out-of-limit fuel balance conditions. Lateral control is not significantly affected when operating with fuel beyond normal balance limits.

The primary purpose for fuel balance alerts is to inform the crew that imbalances beyond the current state may result in increased trim drag and higher fuel consumption. The IMBAL NNC should be accomplished when the fuel balance alert is received.

737 NG Flight Crew Training Manual

There is a common misconception among flight crews that the fuel crossfeed valve should be opened immediately after an in-flight engine shutdown to prevent fuel imbalance. This practice is contrary to Boeing recommended procedures and could aggravate a fuel imbalance. This practice is especially significant if an engine failure occurs and a fuel leak is present. Arbitrarily opening the crossfeed valve and starting fuel balancing procedures, without following the checklist, can result in pumping usable fuel overboard.

The misconception may be further reinforced during simulator training. The fuel pumps in simulators are modeled with equal output pressure on all pumps so opening the crossfeed valve appears to maintain a fuel balance. However, the fuel pumps in the airplane have allowable variations in output pressure. If there is a sufficient difference in pump output pressures and the crossfeed valve is opened, fuel feeds to the operating engine from the fuel tank with the highest pump output pressure. This may result in fuel unexpectedly coming from the tank with the lowest quantity.

Fuel Balancing Considerations

The crew should consider the following when performing fuel balancing procedures:

- use of the Fuel Balancing Supplementary Procedure in conjunction with good crew coordination reduces the possibility of crew errors
- routine fuel balancing when not near the imbalance limit increases the possibility of crew errors and does not significantly improve fuel consumption
- during critical phases of flight, fuel balancing should be delayed until workload permits. This reduces the possibility of crew errors and allows crew attention to be focused on flight path control
- fuel imbalances that occur during approach need not be addressed if the reason for the imbalance is obvious (e.g. engine failure or thrust asymmetry, etc.).

Fuel Leak

Any time an unexpected fuel quantity indication, FMC fuel message, or imbalance condition is experienced, a fuel leak should be considered as a possible cause. Maintaining a fuel log and comparing actual fuel burn to the flight plan fuel burn can help the pilot recognize a fuel leak.

Significant fuel leaks, although fairly rare, are difficult to detect. The Engine Fuel Leak NNC assumes the leak is between the front spar and the engine. This is the most common type of fuel leak since fuel lines are exposed in the strut. Most other fuel lines, such as a crossfeed manifold, are contained within the tanks. A significant fuel leak directly from a tank to the outside is very rare due to the substantial wing structure that forms the tanks.

There is no specific fuel leak annunciation on the flight deck. A fuel leak must be detected by changes or discrepancies in expected fuel consumption, or by some annunciation that occurs because of a fuel leak. Any unexpected and sustained change in fuel quantity or fuel balance should alert the crew to the possibility of a fuel leak.

Some fuel-related checklists (for example, IMBAL) list reasons that a fuel leak should be suspected. This list is not exhaustive and, in all cases the flight crew should use their knowledge of the fuel system and current operating conditions to determine whether a fuel leak should be suspected. Some reasons are:

- The total fuel remaining is less than the planned fuel remaining. The total fuel can be less than planned fuel for a number of reasons, such as a fuel leak, unforecast headwinds, fuel sloshing (such as from high angles of pitch). Sloshing fuel would be a temporary effect. Flight crews should consider these when deciding whether or not to suspect a fuel leak.
- An engine has excessive fuel flow. A faulty fuel flow meter or an engine fuel leak downstream of the fuel flow meter will cause an excessive fuel flow indication. Total fuel remaining compared to planned fuel remaining should be considered when deciding whether or not to suspect a fuel leak.
- One main tank is abnormally low compared to the other main tanks and the expected fuel remaining in the tanks. One tank indicating abnormally low can be caused by a fuel leak, engine out or a crossfeed problem. With an engine out, if the totalizer and calculated values are tracking as expected, a fuel leak would not be suspected. A fuel pump with higher pressure and a faulty crossfeed valve can cause one tank to provide fuel to more than one engine, causing one tank to indicate low. In this case, the fact that total fuel should still match planned fuel, a fuel leak would not be suspected.

If a fuel leak is suspected, it is imperative to follow the NNC.

The NNC leads the crew through steps to determine if the fuel leak is from the strut or the engine area. If an engine fuel leak is confirmed, the NNC directs the crew to shutdown the affected engine. There are two reasons for the shutdown. The first is to close the spar valve, which stops the leak. This prevents the loss of fuel which could result in a low fuel state. The second reason is that the fire potential is increased when fuel is leaking around the engine. The risk of fire increases further when the thrust reverser is used during landing. The thrust reverser significantly changes the flow of air around the engine which can disperse fuel over a wider area.

Low Fuel

A low fuel condition exists when the fuel LOW indication is displayed.

737 NG Flight Crew Training Manual

Approach and Landing

In a low fuel condition, the clean configuration should be maintained as long as possible during the descent and approach to conserve fuel. However, initiate configuration changes early enough to provide a smooth, slow deceleration to final approach speed to prevent fuel from running forward in the tanks.

A normal landing configuration and airspeed appropriate for the wind conditions are recommended.

Runway conditions permitting, heavy braking and high levels of reverse thrust should be avoided to prevent uncovering all fuel pumps and possible engine flameout during landing roll.

Go-Around

If a go-around is necessary, slowly and smoothly advance thrust levers and maintain the minimum nose-up body attitude required for a safe climb gradient. Avoid rapid acceleration of the airplane. If any main tank fuel pump low pressure light illuminates, do not turn the fuel pump switches off.

Hydraulics

Proper planning of the approach is important. Consideration should be given to the effect the inoperative system(s) has on crosswind capabilities, autoflight, stabilizer trim, control response, control feel, reverse thrust, stopping distance, go-around configuration and performance required to reach an alternate airfield.

Hydraulic System(s) Inoperative - Landing

If the landing gear is extended using manual gear extension, the gear cannot be raised. Trailing edge flaps can be extended or retracted using the alternate (electric) system. However, the rate of flap travel is significantly reduced. Leading edge devices can also be extended using the alternate system, but they cannot be retracted.

If system B is lost, or both system A and B are lost, the applicable NNC recommends the use of flaps 15 to improve go-around capabilities. With flaps 15, the airplane may tend to float during the flare. Do not allow the airplane to float. Fly the airplane onto the runway at the recommended point.

If nose wheel steering is inoperative and any crosswind exists, consideration should be given to landing on a runway where braking action is reported as good or better. Braking action becomes the primary means of directional control below approximately 60 knots where the rudder becomes less effective. If controllability is satisfactory, taxi clear of the runway using differential thrust and brakes. Continued taxi with nose wheel steering inoperative is not recommended due to airplane control difficulties and heat buildup in the brakes.

Manual Reversion

With both hydraulic systems A and B inoperative, the ailerons and elevator are controlled manually. A noticeable dead band will be observed in both of these controls. High control forces are required for turns and the control wheel must be deliberately returned to the aileron neutral position.

Both electric and manual trim are still functional. Do not over trim. The airplane should be trimmed slightly nose up and a light forward pressure held on the control column to minimize the effects of the elevator dead band.

The rudder is powered by the standby hydraulic system. Caution must be exercised to not over-control the rudder.

Note: The standby rudder includes a yaw damper which aids roll control handling qualities in the aileron dead band area during manual reversion.

Fly a long straight-in approach. Keep thrust changes small and slow to allow for pitch trim changes. Landing configuration and approach airspeed should be established on the runway centerline so that only a slight reduction in thrust is required to achieve the landing profile. Do not make a flat approach. Anticipate that the airplane tends to pitch down as thrust is reduced for touchdown. To help reduce the pitch down tendency, trim slightly nose up on approach and initiate the flare at a higher than normal altitude. Although trimming during the flare is not normally recommended, the high control column forces required during landing in this situation can be reduced by adding a small amount of nose up trim during the flare.

After touchdown, thrust reverser operation is slow. Apply steady brake pressure since only accumulator pressure is available. Do not apply excessive forward pressure to the control column. Excessive forward pressure without the speedbrakes deployed can result in less weight on the main gear and reduced braking capability.

Do not attempt to taxi the airplane after stopping because the accumulator pressure may be depleted or close to being depleted.

If a go-around is required, apply thrust smoothly and in coordination with stabilizer trim. Rapid thrust application results in nose-up pitch forces.

Landing Gear

Landing Gear Lever Jammed in the Up Position

The landing gear could be jammed in the UP position due to a mechanical jam of the landing gear handle, or if the landing gear selector valve is stuck in the up position. Either condition results in the landing gear remaining pressurized in the UP position.

737 NG Flight Crew Training Manual

The LANDING GEAR LEVER JAMMED IN THE UP POSITION NNC has the crew attempt to bypass the solenoid linkage by pulling the landing gear override trigger. If the landing gear cannot be extended due to a mechanical jam of the landing gear handle, this may resolve the jam. If this action does not result in the landing gear lever moving to the DN position and all landing gear indicating down and locked, the landing gear is most likely jammed in the UP position because the landing gear selector valve is stuck in the up position. In this case the crew must pull the manual gear extension handles to release the uplocks and allow the gears to extend. Due to system redesign in the 737NG, there is no requirement to depressurize either hydraulic system as was required in earlier 737s.

Tire Failure During or After Takeoff

When a tire failure is suspected during takeoff, the landing gear can be retracted normally. Wheel well design features and automatic wheel braking prevent damage from a failed tire. If the landing gear lever cannot move to UP, do the Landing Gear Lever Will Not Move Up After Takeoff NNC as soon as practical.

If the crew suspects a tire failure during takeoff, the Air Traffic Service facility serving the departing airport should be advised of the potential for tire pieces remaining on the runway. The crew should consider continuing to the destination unless there is an indication that other damage has occurred (non-normal engine indications, engine vibrations, hydraulic system failures or leaks, etc.).

Continuing to the destination allows the airplane weight to be reduced normally, and provide the crew an opportunity to plan and coordinate their arrival and landing when the workload is low.

Considerations in selecting a landing airport include, but are not limited to:

- sufficient runway length and acceptable surface conditions to account for the possible loss of braking effectiveness
- sufficient runway width to account for possible directional control difficulties
- altitude and temperature conditions that could result in high ground speeds on touchdown and adverse taxi conditions
- runway selection options regarding “taxi-in” distance after landing
- availability of operator maintenance personnel to meet the airplane after landing to inspect the wheels, tires, and brakes before continued taxi
- availability of support facilities should the airplane need repair.

Landing on a Flat Tire

Boeing airplanes are designed so that the landing gear and remaining tire(s) have adequate strength to accommodate a flat nose gear tire or main gear tire. When the pilot is aware of a flat tire prior to landing, use normal approach and flare techniques, avoid landing overweight and use the center of the runway. Use differential braking as needed for directional control. With a single tire failure, towing is not necessary unless unusual vibration is noticed or other failures have occurred.

In the case of a flat nose wheel tire, slowly and gently lower the nose wheels to the runway while braking lightly. Runway length permitting, use idle reverse thrust. Autobrakes may be used at the lower settings. Once the nose gear is down, vibration levels may be affected by increasing or decreasing control column back pressure. Maintain nose gear contact with the runway.

Flat main gear tire(s) cause a general loss of braking effectiveness and a yawing moment toward the flat tire with light or no braking and a yawing moment away from the flat tire if the brakes are applied harder. Maximum use of reverse thrust is recommended. Do not use autobrakes.

If uncertain whether a nose tire or a main tire has failed, slowly and gently lower the nose wheels to the runway and do not use autobrakes. Differential braking may be required to steer the airplane. Use idle or higher reverse thrust as needed to stop the airplane.

Note: Extended taxi distances or fast taxi speeds can cause significant increases in temperatures on the remaining tires.

Partial or Gear Up Landing

Land on all available gear. The landing gear absorbs the initial shock and delays touchdown of airplane body parts. Cycling the landing gear or maneuvering the airplane in an attempt to extend the remaining gear is not recommended. A gear up or partial gear landing is preferable to running out of fuel while attempting to solve a gear problem.

Landing Runway

Consideration should be given to landing at the most suitable airport with adequate runway and fire fighting capability. Foaming the runway is not necessary. Tests have shown that foaming provides minimal benefit and it takes approximately 30 minutes to replenish the fire truck's foam supply.

Prior to Approach

If time and conditions permit, reduce weight as much as possible by burning off fuel to attain the slowest possible touchdown speed.

737 NG Flight Crew Training Manual

At the captain's command, advise the crew and the passengers of the situation, as needed. Coordinate with all ground emergency facilities. For example, fire trucks normally operate on a common VHF frequency with the airplane and can advise the crew of the airplane condition during the landing. Advise the cabin crew to perform emergency landing procedures and to brief passengers on evacuation procedures.

The NNC instructs the crew to inhibit the ground proximity system as needed to prevent nuisance warnings when close to the ground with the gear retracted.

For landing in any gear configuration, establish approach speed early and maintain a normal rate of descent.

Landing Techniques

Attempt to keep the airplane on the runway to minimize airplane damage and aid in evacuation. After touchdown lower the nose gently before losing elevator effectiveness. Use all aerodynamic capability to maintain directional control on the runway. At touchdown speed, the rudder has sufficient authority to provide directional control in most configurations. At speeds below 60 knots, use nose wheel/rudder pedal steering, if available, and differential braking as needed.

Use of Speedbrakes

During a partial gear or gear up landing, speedbrakes should be extended only when stopping distance is critical. Extending the speedbrakes before all gear, or the nose or the engine nacelle in the case of a gear that does not extend, have contacted the runway may compromise controllability of the airplane.

Extending the speedbrakes after a complete touchdown also creates a risk of not being able to stow the speedbrakes after the airplane has come to a rest. If this is the case, there would be an increase in the probability of injuring passengers if the over wing exits are used for evacuation.

When landing with any gear that indicates up or partially extended, attempt to fly the area with the unsafe indication smoothly to the runway at the lowest speed possible, but before losing flight control effectiveness. A smooth touchdown at a low speed helps to reduce airplane damage and offers a better chance of keeping the airplane on the runway. Since the airplane is easier to control before body parts make ground contact, delay extending the speedbrakes until after the nose and both sides of the airplane have completed touchdown. If the speedbrakes are deployed before all areas have made contact with the runway, the airplane will complete touchdown sooner and at a higher speed.

Some crews or operators may elect to avoid the use of speedbrakes during any landing with a partial gear indication. However, most partial gear indications are the result of an indicator malfunction rather than an actual gear up condition. If the crew elects not to use speedbrakes during landing, be aware that stopping distance may rapidly become critical if all gear remain extended throughout touchdown and rollout.

Use of Reverse Thrust

During a partial gear or gear up landing, an engine making ground contact could suffer sufficient damage such that the thrust reverser mechanism may not operate. Selecting reverse thrust with any gear not extended may produce an additional asymmetric condition that makes directional control more difficult. Reverse thrust should be used only when stopping distance is critical.

If reverse thrust is needed, keep in mind that the airplane is easier to control before body parts make ground contact. If the thrust reversers are deployed before all gear, or the nose or the engine nacelle in the case of a gear that does not extend, have made contact with the runway, the airplane will complete touchdown sooner and at a higher speed.

After Stop

Accomplish an evacuation, if needed.

Partial or Gear Up Combinations

Both Main Gear Extended with Nose Gear Up

Land in the center of the runway. After touchdown lower the nose gently before losing elevator effectiveness. Do not attempt to hold the nose of the airplane off the runway.

Nose Gear Only Extended

Land in the center of the runway. Use normal approach and flare attitudes maintaining back pressure on the control column until ground contact. The engines contact the ground prior to the nose gear.

One Main Gear Extended and Nose Gear Extended

Land the airplane on the side of the runway that corresponds to the extended main gear down. At touchdown, maintain wings level as long as possible. Use rudder and nose wheel steering for directional control. After all gear, or the engine nacelle on the side where the gear is not extended, have made contact with the runway, braking on the side with the main gear extended should be used as needed to keep the airplane rolling straight.

737 NG Flight Crew Training Manual

One Main Gear Only Extended

Land the airplane on the side of the runway that corresponds to the extended main gear down. At touchdown, maintain wings level as long as possible. Use rudder for directional control. After all gear, or the nose or the engine nacelle of gear on the side that do not extend, have made contact with the runway, braking on the side with the main gear extended should be used as needed to keep the airplane rolling straight.

All Gear Up or Partially Extended

Land in the center of the runway. The engines contact the ground first. There is adequate rudder available to maintain directional control during the initial portion of the ground slide. Attempt to maintain the centerline while rudder control is available.

Overspeed

VMO/MMO is the airplane maximum certified operating speed and should not be exceeded intentionally. However, crews can occasionally experience an inadvertent overspeed. Airplanes have been flight tested beyond VMO/MMO to ensure smooth pilot inputs will return the airplane safely to the normal flight envelope.

At high altitude, wind speed or direction changes may lead to overspeed events. Although autothrottle logic provides for more aggressive control of speed as the airplane approaches VMO or MMO, there are some conditions that are beyond the capability of the autothrottle system to prevent short term overspeeds.

When correcting an overspeed during cruise at high altitude, avoid reducing thrust to idle which results in slow engine acceleration back to cruise thrust and may result in over-controlling the airspeed or a loss of altitude. If autothrottle corrections are not satisfactory, leave the autopilot engaged, deploy partial speedbrakes slowly until a noticeable reduction in airspeed is achieved. When the airspeed is below VMO/MMO, retract the speedbrakes at the same rate as they were deployed. The thrust levers can be expected to advance slowly to achieve cruise airspeed; if not, they should be pushed up more rapidly.

During descents at or near VMO/MMO, most overspeeds are encountered after the autopilot initiates capture of the VNAV path from above or during a level-off when the speedbrakes were required to maintain the path. In these cases, if the speedbrakes are retracted during the level-off, the airplane can momentarily overspeed. During descents using speedbrakes near VMO/MMO, delay retraction of the speedbrakes until after VNAV path or altitude capture is complete. Crews routinely climbing or descending in windshear conditions may wish to consider a 5 to 10 knot reduction in climb or descent speeds to reduce overspeed occurrences. This will have a minimal effect on fuel consumption and total trip time.

When encountering an inadvertent overspeed condition, crews should leave the autopilot engaged and use the speedbrakes as needed unless it is apparent that the autopilot is not correcting the overspeed. However, if manual inputs are required, disengage the autopilot. Be aware that disengaging the autopilot to avoid or reduce the severity of an inadvertent overspeed may result in an abrupt pitch change.

During climb or descent, if VNAV or LVL CHG pitch control is not correcting the overspeed satisfactorily, switching to the V/S mode temporarily may be helpful in controlling speed. In the V/S mode, the selected vertical speed can be adjusted slightly to increase the pitch attitude to help correct the overspeed. As soon as the speed is below VMO/MMO, VNAV or LVL CHG may be re-selected.

Note: Anytime VMO/MMO is exceeded, the maximum airspeed should be noted in the flight log.

Tail Strike

Tail strike occurs when the lower aft fuselage or tail skid (as installed) contacts the runway during takeoff or landing. A significant factor that appears to be common is the lack of flight crew experience in the model being flown.

A tail strike can be identified by the flight crew or cabin crew.

Any one of the following conditions can be an indication of a tail strike during rotation or flare:

- a noticeable bump or jolt
- a scraping noise from the tail of the airplane
- pitch rate stopping momentarily

737-800 - 737-900ER

- the TAILSTRIKE HUD warning (as installed) may be displayed

Note: Anytime fuselage contact is suspected or confirmed, accomplish the appropriate NNC without delay.

Takeoff Risk Factors

Understanding the factors that contribute to a tail strike can reduce the possibility of a tail strike occurrence.

Any one of the following takeoff risk factors may precede a tail strike:

737 NG Flight Crew Training Manual

Mistrimmed Stabilizer

This usually results from using erroneous takeoff data, e.g., the wrong weights, or an incorrect center of gravity (CG). In addition, sometimes information is entered incorrectly either in the flight management system (FMS) or set incorrectly on the stabilizer. The flight crew can prevent this type of error and correct the condition by challenging the reasonableness of the load sheet numbers. Comparing the load sheet numbers against past experience in the airplane can assist in approximating numbers that are reasonable.

Rotation at Improper Speed

This situation can result in a tail strike and is usually caused by early rotation due to some unusual situation, or rotation at too low an airspeed for the weight and/or flap setting.

Trimming during Rotation

Trimming the stabilizer during rotation may contribute to a tail strike. The pilot flying may easily lose the feel of the elevator while the trim is running which may result in an excessive rotation rate.

Excessive Rotation Rate

Flight crews operating an airplane model new to them, especially when transitioning from an airplane with unpowered flight controls to one with hydraulic assistance, are most vulnerable to using excessive rotation rate. The amount of control input required to achieve the proper rotation rate varies from one model to another. When transitioning to a new model, flight crews may not realize that it does not respond to pitch input in exactly the same way as their previous model.

Improper Use of the Flight Director

The flight director provides accurate pitch guidance only after the airplane is airborne. With the proper rotation rate, the airplane reaches 35 feet with the desired pitch attitude of about 15°. However, an aggressive rotation into the pitch bar at takeoff is not appropriate and can cause a tail strike.

Landing Risk Factors

A tail strike on landing tends to cause more serious damage than the same event during takeoff and is usually more expensive and time consuming to repair. In the worst case, the tail can strike the runway before the landing gear, thus absorbing large amounts of energy for which it is not designed. The aft pressure bulkhead is often damaged as a result.

Any one of the following landing risk factors may precede a tail strike:

Unstabilized Approach

An unstabilized approach is the biggest single cause of tail strike. Flight crews should stabilize all approach variables - on centerline, on approach path, on speed, and in the final landing configuration - by the time the airplane descends through 1,000 feet AFE. This is not always possible. Under normal conditions, if the airplane descends through 1,000 feet AFE (IMC), or 500 feet AFE (VMC), with these approach variables not stabilized, a go-around should be considered. See the section titled “Stabilized Approach Recommendations” in chapter 5 of this manual for more detailed information on the stabilized approach.

Flight recorder data shows that flight crews who continue with an unstabilized condition below 500 feet seldom stabilize the approach. When the airplane arrives in the flare, it often has either excessive or insufficient airspeed. The result is a tendency toward large thrust and pitch corrections in the flare, often culminating in a vigorous pitch change at touchdown resulting in tail strike shortly thereafter. If the pitch is increased rapidly when touchdown occurs as ground spoilers deploy, the spoilers add additional nose up pitch force, reducing pitch authority, which increases the possibility of a tail strike. Conversely, if the airplane is slow, increasing the pitch attitude in the flare does not effectively reduce the sink rate; and in some cases, may increase it.

A firm touchdown on the main gear is often preferable to a soft touchdown with the nose rising rapidly. In this case, the momentary addition of thrust may aid in preventing the tail strike. In addition, unstabilized approaches can result in landing long or a runway over run.

Holding Off in the Flare

The second most common cause of a landing tail strike is an extended flare, with a loss in airspeed that results in a rapid loss of altitude, (a dropped-in touchdown). This condition is often precipitated by a desire to achieve an extremely smooth/soft landing. A very smooth/soft touchdown is not essential, nor even desired, particularly if the runway is wet.

Trimming in the Flare

Trimming the stabilizer in the flare may contribute to a tail strike. The pilot flying may easily lose the feel of the elevator while the trim is running. Too much trim can raise the nose, even when this reaction is not desired. The pitch up can cause a balloon, followed either by dropping in or pitching over and landing in a three-point attitude. Flight crews should trim the airplane during the approach, but not in the flare.

737 NG Flight Crew Training Manual

Mishandling of Crosswinds

When the airplane is placed in a sideslip attitude to compensate for the wind effects, this cross-control maneuver reduces lift, increases drag, and may increase the rate of descent. If the airplane then descends into a turbulent surface layer, particularly if the wind is shifting toward the tail, the stage is set for a tail strike.

The combined effects of high closure rate, shifting winds with the potential for a quartering tail wind, can result in a sudden drop in wind velocity commonly found below 100 feet. Combining this with turbulence can make the timing of the flare very difficult. The pilot flying can best handle the situation by using additional thrust, if needed, and by using an appropriate pitch change to keep the descent rate stable until initiation of the flare. Flight crews should clearly understand the criteria for initiating a go-around and plan to use this time-honored avoidance maneuver when needed.

Over-Rotation during Go-Around

Go-arounds initiated very late in the approach, such as during the landing flare or after touching down, are a common cause of tail strikes. When the go-around mode is initiated, the flight director immediately commands a go-around pitch attitude. If the pilot flying abruptly rotates up to the pitch command bar, a tail strike can occur before the airplane responds and begins climbing. During a go-around, an increase in thrust as well as a positive pitch attitude is needed. If the thrust increase is not adequate for the increased pitch attitude, the resulting speed decay will likely result in a tail strike. Another contributing factor in tail strikes may be a strong desire by the flight crew to avoid landing gear contact after initiating a late go-around when the airplane is still over the runway. In general, this concern is not warranted because a brief landing gear touchdown during a late go-around is acceptable. This had been demonstrated during autoland and go-around certification programs.

Warning Systems

If an unexpected landing gear configuration or GPWS alert occurs, the flight crew must ensure the proper configuration for the phase of flight. Time may be required in order to assess the situation, take corrective action and resolve the discrepancy. Flight path control and monitoring of instruments must never be compromised.

Note: If the warning occurs during the approach phase, a go-around may be necessary, followed by holding or additional maneuvering.

Fire

Cargo Fire

The cargo smoke detection system provides indication of smoke within the forward or aft lower lobe cargo compartments and main deck cargo compartment (737 BCF airplanes only). Once detection occurs the cargo fire checklist should be completed to activate the suppression system or ventilation shutoff (737 BCF airplanes only) and prevent smoke migration into occupied areas. Once the cargo fire suppression system or ventilation system is activated, the fire should be controlled for the duration of the flight. Smoke may remain in or continue to be generated within the compartment until the fire is extinguished by fire personnel. Cargo compartment fire warning indications may extinguish, may remain illuminated or may extinguish and re-illuminate over the duration of the flight. Continued indications of a cargo fire within the same compartment do not indicate the fire is uncontrolled. Small amounts of smoke can migrate into occupied areas of the airplane. However, increasing amounts of smoke can be an indication the fire is uncontrolled.

The cargo smoke detection or fire suppression systems do not provide an indication of the severity of the fire. Therefore, continued cargo compartment fire warnings alone should not be considered an indication of an uncontrollable fire. The crew must assess the situation and use good judgment to determine the safest course of action. All immediately available resources should be considered prior to executing an off-airport landing or a ditching.

Wheel Well Fire

Prompt execution of the WHEEL WELL FIRE NNC following a wheel well fire warning is important for timely gear extension. Landing gear speed limitations should be observed during this checklist.

Note: To avoid unintended deceleration below the new target airspeed, the autothrottle should remain engaged.

If airspeed is above 270 knots/.82 Mach, the airspeed must be reduced before extending the landing gear. Either of the following techniques results in the autothrottle reverting to the SPD mode and provides a more rapid speed reduction than using VNAV speed intervention or LVL CHG.

- select altitude hold and set approximately 250 knots
- for airplanes equipped with speed intervention, set the MCP altitude to a desired level off altitude and use speed intervention to reduce airspeed.

Note: Additionally, the thrust levers may be reduced to idle and/or the speedbrakes may be used to expedite deceleration.

737 NG Flight Crew Training Manual

If the pitch mode is VNAV and the crew wishes to remain in that mode, select speed intervention (as installed) to open the MCP command speed window and then set approximately 250 knots. If the pitch mode is LVL CHG and the crew wishes to remain in that mode, simply set approximately 250 knots. These techniques do not result in as rapid a speed reduction as reverting to the SPD mode, but allows the crew to remain in the pitch mode in use.

Windows

Window Damage

To do the Window Damage NNC, the flight crew may need to determine if the inner pane of the affected window is cracked or shattered. This can be done by placing the point of an object such as a pencil on the crack, and then moving the head while focusing on the point of the object. If the crack appears to move relative to the point of the object, the crack is not in the inner pane. If the crack does not appear to move relative to the point of the object, the crack is in the inner pane. A crack in the inner pane may also be detected by running a fingernail across the window's surface.

On window 4, these checks will not aid in determining if a middle or outer pane is cracked or shattered. Since it is unlikely that the crew can tell whether a window 4 middle or outer pane is cracked or shattered, the checklist directs action based on a middle pane cracked or shattered.

On window 1, 2, 3 heated (as installed), and 5, if the flight crew is uncertain which pane is cracked or shattered, assume that the inner pane is cracked or shattered and continue with the checklist.

If both forward windows delaminate or forward vision is unsatisfactory, accomplish an ILS or GLS autoland, if available.

Flight with the Side Window(s) Open

The inadvertent opening of an unlatched flight deck window by air loads during the takeoff roll is not considered an event that warrants a high speed RTO. Although the resulting noise levels may interfere with crew communications, it is safer to continue the takeoff and close the window after becoming airborne and the flight path is under control. The flight may be continued once the window is closed and locked and pressurization is normal. If the window is damaged and will not close, return to the departure airport.

If needed, the windows may be opened in-flight after depressurizing the airplane. It is recommended that the airplane be slowed since the noise levels increase at higher airspeed. Maneuver speed for the current flap setting is a good target speed. Intentions should be briefed and ATC notified prior to opening the window as the noise level can be high and make communications difficult, even at slow speeds. However, there is very little turbulence on the flight deck. Because of airplane design, there is an area of relatively calm air over the open window. Forward visibility can be maintained by looking out of the open window using care to stay clear of the airstream.

Situations Beyond the Scope of Non-Normal Checklists

It is rare to encounter in-flight events which are beyond the scope of the Boeing recommended NNCs. These events can arise as a result of unusual occurrences such as a midair collision, bomb explosion or other major malfunction. In these situations the flight crew may be required to accomplish multiple NNCs, selected elements of several different NNCs applied as necessary to fit the situation, or be faced with little or no specific guidance except their own judgment and experience. Because these situations are rare, it is not practical or possible to create definitive flight crew NNCs to cover all events.

The following guidelines may aid the flight crew in determining the proper course of action should an in-flight event of this type be encountered. Although these guidelines represent what might be called “conventional wisdom”, circumstances determine the course of action which the crew perceives will conclude the flight in the safest manner.

Basic Aerodynamics and Systems Knowledge

Knowledge of basic aerodynamic principles and airplane handling characteristics and a comprehensive understanding of airplane systems can be key factors in situations of this type.

737 NG Flight Crew Training Manual

Basic aerodynamic principles are known and understood by all pilots. Although not a complete and comprehensive list, the following is a brief review of some basic aerodynamic principles and airplane systems information relevant to such situations:

- if aileron control is affected, rudder inputs can assist in countering unwanted roll tendencies. The reverse is also true if rudder control is affected
- if both aileron and rudder control are affected, the use of asymmetrical engine thrust may aid roll and directional control
- if elevator control is affected, stabilizer trim, bank angle and thrust can be used to control pitch attitude. To do this effectively, engine thrust and airspeed must be coordinated with stabilizer trim inputs. The airplane continues to pitch up if thrust is increased and positive corrective action is not taken by re-trimming the stabilizer. Flight crews should be aware of the airplane's natural tendency to oscillate in the pitch axis if the stable pitch attitude is upset. These oscillations are normally self damping in Boeing airplanes, but to ensure proper control, it may be desirable to use thrust and/or stabilizer trim to hasten damping and return to a stable condition. The airplane exhibits a pitch up when thrust is increased and a pitch down when thrust is decreased. Use caution when attempting to dampen pitch oscillations by use of engine thrust so that applications of thrust are timed correctly, and diverging pitch oscillations do not develop
- a flight control break-out feature is designed into all Boeing airplanes. If a jammed flight control exists, both pilots can apply force to either clear the jam or activate the break-out feature. There should be no concern about damaging the mechanism by applying too much force. In certain cases, clearing the jam may permit one of the control columns to operate the flight controls with portions of a control axis jammed. It may be necessary to apply break-out forces for the remainder of the flight on the affected control axis
- stall margin decreases with angle of bank and increasing load factors. Therefore, it is prudent to limit bank angle to 15° in the event maneuver capability is in question. Increasing the normal flap/speed maneuver schedule while staying within flap placard limits provides extra stall margin where greater bank angles are necessary
- all Boeing airplanes have the capability to land using any flap position, including flaps up. Use proper maneuver and final approach speeds and ensure adequate runway is available to stop the airplane after landing.

Flight Path Control

When encountering an event of the type described above, the flight crew's first consideration should be to maintain or regain full control of the airplane and establish an acceptable flight path. This may require use of unusual techniques such as the application of full aileron or rudder or in an asymmetrical thrust situation, reduction of thrust on the operating engine(s) to regain lateral control. This may also require trading altitude for airspeed or vice versa. The objective is to take whatever action is necessary to control the airplane and maintain a safe flight path. Even in a worst case condition where it is not possible to keep the airplane flying and ground contact is imminent, a "controlled crash" is a far better alternative than uncontrolled flight into terrain.

If the operation of flaps is in doubt, leading and trailing edge flap position should not be changed unless it appears that airplane performance immediately requires such action. Consideration should be given to the possible effects of an asymmetrical flap condition on airplane control if flap position is changed. If no flap damage exists, wing flaps should be operated as directed in the associated NNC. Anytime an increasing rolling moment is experienced during flap transition (indicating a failure to automatically shutdown an asymmetric flap situation), return the flap handle to the previous position.

Directional Control During Landing Ground Roll

Unusual events adversely affecting airplane handling characteristics while airborne may continue to adversely affect airplane handling characteristics during landing ground roll. Aggressive differential braking, use of rudder pedal steering and/or use of asymmetrical reverse thrust, in addition to other control inputs, may be required to maintain directional control.

Upon landing and rollout, if directional control cannot be maintained by normal control inputs, careful use of nose wheel steering control wheel may be necessary.

Note: Use of nose wheel steering control wheel is not recommended until reaching taxi speed.

Checklists with Memory Steps

After flight path control has been established, do the memory steps of the appropriate NNC. The emphasis at this point should be on containment of the problem. Reference steps are initiated after the airplane flight path and configuration are properly established.

Complete all applicable NNCs prior to beginning final approach. Exercise common sense and caution when accomplishing multiple NNCs with conflicting directions. The intended course of action should be consistent with the damage assessment and handling evaluation.

737 NG Flight Crew Training Manual

Communications

Establish flight deck communications as soon as possible. This may require use of the flight deck interphone system or, in extreme cases of high noise levels, hand signals and gestures in order to communicate effectively.

Declare an emergency with Air Traffic Control (ATC) to assure priority handling and emergency services upon landing. Formulate an initial plan of action and inform ATC. If possible, request a discrete radio frequency to minimize distractions and frequency changes. If unable to establish radio communication with ATC, squawk 7700 and proceed as circumstances dictate.

Communications with the cabin crew and with company ground stations are important, but should be accomplished as time permits. If an immediate landing is required, inform the cabin crew as soon as possible.

Damage Assessment and Airplane Handling Evaluation

Unless circumstances such as imminent airplane breakup or loss of control dictate otherwise, the crew should take time to assess the effects of the damage and/or conditions before attempting to land. Make configuration and airspeed changes slowly until a damage assessment and airplane handling evaluation have been done and it is certain that lower airspeeds can be safely used. In addition, limit bank angle to 15° and avoid large or rapid changes in engine thrust and airspeed that might adversely affect controllability. If possible, conduct the damage assessment and handling evaluation at an altitude that provides a safe margin for recovery should flight path control be inadvertently compromised. It is necessary for the flight crew to use good judgment in consideration of the existing conditions and circumstances to determine an appropriate altitude for this evaluation.

The evaluation should start with an examination of flight deck indications to assess damage. Consideration should be given to the potential cumulative effect of the damage. A thorough understanding of airplane systems operation can greatly facilitate this task.

If structural damage is suspected, attempt to assess the magnitude of the damage by direct visual observation from the flight deck and/or passenger cabin. While only a small portion of the airplane is visible to the flight crew from the flight deck, any visual observation data can be used to gain maximum knowledge of airplane configuration and status and can be valuable in determining subsequent actions.

The flight crew should consider contacting the company to inform them of the situation and use them as a potential source of information. In addition to current and forecast weather, and airfield conditions, it may be possible to obtain technical information and recommendations from expert sources. These expert sources are available from within the company as well as from Boeing.

If controllability is in question, consider performing a check of the airplane handling characteristics. The purpose of this check is to determine minimum safe speeds and the appropriate configuration for landing. If flap damage has occurred, prior to accomplishing this check, consider the possible effects on airplane control should an asymmetrical condition occur if flap position is changed. Accomplish this check by slowly and methodically reducing speed and lowering the flaps. Lower the landing gear only if available thrust allows.

As a starting point, use the flap/speed schedule as directed in the appropriate NNC. If stick shaker or initial stall buffet are encountered at or before reaching the associated flap speed, or if a rapid increase in wheel deflection and full rudder deflection are necessary to maintain wings level, increase speed to a safe level and consider this speed to be the minimum approach speed for the established configuration.

After the damage assessment and handling characteristics are evaluated, the crew should formulate a sequential plan for the completion of the flight.

If airplane performance is a concern, use of the alternate flap or gear extension systems may dictate that the check of airplane handling characteristics be done during the actual approach. Configuration changes made by the alternate systems may not be reversible. The crew must exercise extreme caution on final approach with special emphasis on minimum safe speeds and proper airplane configuration. If asymmetrical thrust is being used for roll control or pitch authority is limited, plan to leave thrust on until touchdown.

Landing Airport

The following items should be considered when selecting an airport for landing:

- weather conditions (VMC preferred)
- enroute time
- length of runway available (longest possible runway preferred, wind permitting)
- emergency services available
- flight crew familiarity
- other factors dictated by the specific situation.



Preface

Information contained in this appendix is provided by the operator of organizations that use the 737 NG Flight Crew Training Manual.

UNCONTROLLED
IF PRINTED

Intentionally
Blank

UNCONTROLLED
IF PRINTED



Preface

Recommendations contained in this appendix are provided for the operations staff of operators that use the 737 NG Flight Crew Training Manual. Recommendations are based on Boeing experience, and are intended as guidance for consideration by each operator. Individual operators are responsible for determining the applicability of these recommendations to their operations. Some of these recommendations may need to be coordinated with applicable regulatory agencies.

Operational Philosophy

Events Requiring Maintenance Inspection

FCTM 1.4

Most operators establish procedures or policies to ensure that aircrews document ground or flight events which require a maintenance inspection after flight. Chapter 5 of the Aircraft Maintenance Manual (AMM) refers to such events as “Conditional Inspections”. Additional events, that are not listed in chapter 5 but may require maintenance inspection, should also be addressed.

Callouts

FCTM 1.19

Recommended callouts are provided in the interest of good Crew Resource Management. Operators are encouraged to develop their own recommended callouts based upon their fleet configuration. Operators may modify, supplement, or eliminate recommended callouts provided in this manual as they determine best practices for their operational needs. However, procedural callouts found in this list should be accomplished as indicated in the Procedures section of the FCOM.

Cold Temperature Altitude Corrections

FCTM 1.28

Operator coordination with local and en route air traffic control facilities is recommended for each cold weather airport or route in the system. Coordination should include:

- confirmation that minimum assigned altitudes or flight levels provide adequate terrain clearance for the coldest expected temperatures
- cold weather altitude correction procedures to be used for published procedures, to include the table being used
- a determination of which procedures or routes, if any, that have been designed for cold temperatures and can be flown as published (without altitude corrections).

RNAV Operations

Basic RNP Concept

FCTM 1.36

Operators should select FMC default values for RNP that meet the requirements of their route structure or terminal area procedures.

RNP APCH

Operators that are required to develop specific procedures for RNP APCH can reference the RNP Capability document Appendix A for required equipment list and additional items for pilot procedures as needed.

GPS Use in Non-WGS-84 Reference Datum Airspace

FCTM 1.40

Operators should consult appropriate sources to determine the current status of airspace in which they operate. Recommendations for operators are as follows:

- provided operational approval has been received and measures to ensure their accuracy have been taken, RNAV approaches may be flown with GPS updating enabled. Options available to operators may include surveys of the published approaches to determine if significant differences or position errors exist, developing special RNAV procedures complying with WGS-84 or equivalent, or inhibiting GPS updating
- for approaches based upon ground-based navigation aids such as ILS, VOR, LOC, NDB, etc., the GPS updating need not be inhibited provided that appropriate raw data is used throughout the approach and missed approach as the primary navigation reference. LNAV and VNAV may be used. As always, when a significant difference exists between the airplane position, raw data course, DME and/or bearing information, discontinue use of LNAV and VNAV. Provided the FMC is not used as the primary means of navigation for approaches, this method can be used as the “other appropriate procedure” in lieu of inhibiting GPS updating.

Operators are encouraged to survey their navigation databases and have all public non-WGS-84 procedures eliminated.

Automation Use Guidelines to Maintain Manual Flight Proficiency

Operators are encouraged to develop an automation use policy that gives pilots the opportunity to maintain proficiency in manual flight. The policy should encourage the crew to fly the airplane manually, as long as conditions and workload for both the pilot flying and pilot monitoring are such that safe operations are maintained.

Maintaining proficiency in manual flying skills will increase the level of preparedness to respond appropriately to unexpected deviation from planned flight path. Manual flight proficiency will help the crew manage unexpected events when less aircraft automation is available. Additionally, regular practice of manual flight reinforces manual flying capabilities which can help the crew adapt to other situations requiring manual flight.

AFDS Guidelines

FCTM 1.40

MCP Altitude Setting Techniques Using VNAV

Alternate MCP Altitude Setting Technique

FCTM 1.44

Operators who wish to use the alternate MCP altitude setting technique for closely spaced altitude constraints should ensure crews are aware of the criticality of remaining in VNAV PTH and the potential for crew error. Operators should evaluate departures, arrivals, and approaches to determine which MCP technique is most appropriate and establish appropriate guidance and training to ensure that crews fully understand the following:

- to which terminal procedures this alternate technique applies
- during departures or arrivals, the selection of a pitch mode other than VNAV PTH or VNAV SPD will result in a risk of violating procedure altitude constraints.
- the possibility of deleting waypoint altitude constraints if altitude intervention is selected as described in chapter 5.

Note: Operators may also wish to use the alternate MCP altitude setting technique for Tailored Arrivals (TA) regardless of how closely the altitude constraints are spaced.

Push Back or Towing

FCTM 2.2

The development of specific pushback and towing procedures and policies, which are tailored for specific operations, are recommended. The flight operations and maintenance departments need to be primary in developing these procedures.

Proper training of both pilots and ground maintenance and good communication between the flight deck and ground personnel are essential for a safe operation.

Engine Out Taxi

FCTM 2.17

If operator policies, procedures and flight crew familiarization materials are appropriately applied, EOT operations can be conducted safely and should be acceptable to flight crews and regulatory authorities.

Operator policies, procedures and flight crew familiarization materials should include, but not be limited to the following:

- airport layout
- taxiway composition

737 NG Flight Crew Training Manual

- taxiway slope
- foreign object damage (FOD)
- airplane system redundancy
- engine warm-up and cool down times
- fuel balancing
- crew workload and heads-down time
- current weather, including temperature and wind
- current taxiway surface conditions

Each operator should establish Standard Operating Procedures (SOP) for EOT operations. These SOPs should provide the flight crew with clear, concise guidance for EOT operations.

More information on EOT operations is available in the Boeing Flight Operations Technical Bulletin titled “Engine Out Taxi”. This Bulletin can be found on MyBoeingFleet.

Crosswind Takeoff

Takeoff Crosswind Guidelines

[FCTM 3.14](#)

Crosswind guidelines are not considered limitations. Crosswind guidelines are provided to assist operators in establishing their own crosswind policies. These guidelines are based upon steady wind (no gust) conditions. Operators need to address the increased workload associated with gusts when developing their own crosswind policies. If an operator is unable to establish crosswind policies, with gusts, the recommended crosswind guidelines provided should be used.

Low Visibility Takeoff

[FCTM 3.20](#)

Low visibility takeoff operations, below landing minima, may require a takeoff alternate. When selecting a takeoff alternate, consideration should be given to unexpected events such as an engine failure or other non-normal situation that could affect landing minima at the takeoff alternate. Operators, who have authorization for engine inoperative Category II/III operations, may be authorized lower alternate minima.

With proper crew training and appropriate runway lighting, takeoffs with visibility as low as 500ft/150m RVR may be authorized (FAA). With takeoff guidance systems and centerline lighting that meets FAA or ICAO criteria for Category III operations, takeoffs with visibility as low as 300ft/75m RVR may be authorized. Regulatory agencies may impose takeoff crosswind limits specifically for low visibility takeoffs.

All RVR readings must be equal to or greater than required takeoff minima. If the touchdown or rollout RVR system is inoperative, the mid RVR may be substituted for the inoperative system. When the touchdown zone RVR is inoperative, pilot estimation of RVR may be authorized by regulatory agencies.

Adverse Runway Conditions

FCTM 3.21

Most operators specify weight reductions to the AFM field length and/or obstacle limited takeoff weight based upon the depth of powdery snow, slush, wet snow or standing water and a maximum depth where the takeoff should not be attempted.

Takeoff Engine Failure

Engine Failure During a Combined ATM and Fixed Derate Takeoff

FCTM 3.42

If an engine failure occurs during takeoff when using both the reduced thrust (ATM) and fixed derate methods, Boeing recommends that the thrust levers not be advanced. This is because the fixed derate limit is not displayed on engine or flight instruments. However, if operators wish to allow crews to increase thrust up to the fixed derate limit, they should develop and train procedures that make the fixed derate limit immediately available to the crew during takeoff.

Cruise

Maximum Altitude

FCTM 4.5

The minimum maneuver speed indication on the speed tape or airspeed display does not guarantee the ability to maintain level flight at that speed. Decelerating the airplane to the amber band may create a situation where it is impossible to maintain speed and/or altitude because as speed decreases airplane drag may exceed available thrust, especially while turning. Operators may wish to reduce exposure to this situation by changing the FMC parameters (via maintenance action) to suit individual operator needs. Flight crews intending to operate at or near the maximum operation altitude should be familiar with the performance characteristics of the airplane in these conditions.

Optimum Altitude

FCTM 4.6

Trip altitude, as defined on the FMC PERF INIT page, further constrains optimum altitude by reducing the altitude for short trips until minimum cruise segment time is satisfied. This cruise time is typically one minute, but is operator selectable in the FMC by maintenance action. For short trips, operation at the trip altitude results in the minimum fuel/cost while also satisfying the minimum cruise time requirement.

ETOPS

ETOPS Requirements and Approval

FCTM 4.14

FAA operators conducting ETOPS are required to comply with FAA regulations and Advisory Circulars. Other regulatory agencies may have different requirements or governing rules.

Operators must have an ETOPS configured airplane, and approved flight operations and maintenance programs in place to support ETOPS. These programs normally ensure that the ETOPS airplane is in compliance with the requirements of the appropriate Configuration, Maintenance and Procedures (CMP) documents. The operator's maintenance department must develop programs which monitor and report reliability of the engines, airframe and ETOPS significant components. The Minimum Equipment List (MEL) and the Dispatch Deviations Guide (DDG) have been expanded to address the improved redundancy levels and the additional equipment unique to ETOPS configured airplanes.

Note: Reference MyBoeingFleet for more information on ETOPS.

Flight and Performance

FCTM 4.14

Critical fuel calculations are part of the ETOPS dispatch process and are not normally calculated by the flight crew. The crew normally receives ETOPS critical fuel information in the Computer Flight Plan (CFP).

Polar Operations

FCTM 4.15

Operators should develop a remote airport diversion plan to include supporting the airplane, passengers, and crew. Airplane equipment and document needs to be considered include, but are not necessarily limited to:

- cold weather clothing to enable a minimum of two crewmembers to exit the airplane at a diversion airport with extreme cold conditions
- comprehensive instructions on securing the airplane for cold weather to include draining water tanks, etc.
- diversion airport data to include airport diagrams, information on nearby terrain and photographs (if available), emergency equipment availability, etc.

Approach

Approach Category

FCTM 5.3

An operator may use a different approach category as determined in coordination with the applicable regulatory authority.

Due to the numerous maximum landing weight options in the 737-600 through 737-900ER variants, determining an airplane approach category may be done using the certified maximum flap setting of 40 and the particular airplane's AFM maximum certificated landing weight under FAA criteria.

ILS or GLS Approach

Low Visibility Approaches

AFDS System Configuration

FCTM 5.23

The airplane equipment needed for Category II and Category III approaches is contained in the AFM. Operators are responsible for reviewing their AFM to determine equipment needed and submit these requirements along with other data to their applicable regulator in order to get approval for Cat II or III operations. However, the requirements in the AFM do not necessarily denote all of the systems and equipment required for the types of operation specified. Applicable regulations may prescribe an operational requirement for additional systems (e.g. autobrake). Operators who have been approved for Cat II and III operations and have airplanes certified for these operations need to provide this information to their pilots.

737 NG Flight Crew Training Manual

More detailed information concerning Category II and Category III operational requirements can be found in FAA advisory circulars or similar documents from other regulatory agencies. The manufacturer's demonstrated compliance with the airworthiness performance standards does not constitute approval to conduct operations in lower weather minimums.

AFDS Faults**FCTM 5.24**

Operators are responsible for reviewing their AFM and FAA advisory circulars or similar documents from other regulatory agencies to establish a pilot response if any of the required airplane equipment fails or the AFDS is degraded during a Category II or Category III approach.

The pilot response along with other data should be submitted to the applicable regulator for approval. The operator needs to provide this information to their pilots.

More detailed information concerning Category II and Category III operational requirements can be found in FAA advisory circulars or similar documents from other regulatory agencies. The manufacturer's demonstrated compliance with the airworthiness performance standards does not constitute approval to conduct operations in lower weather minimums.

Non-ILS Instrument Approaches**Vertical Path Construction****FCTM 5.43**

The use of VNAV PTH for ILS approaches flown G/S OUT where step-down fixes are published between the FAF and the MAP is not recommended without specific operator approval. Operator approval should be based upon analysis that the VNAV path or IAN glide path will clear all step down fixes.

Instrument Approach - RNAV (RNP) AR**Instrument Approach - RNAV (RNP) AR - General****FCTM 5.63**

Operators need approval to conduct RNAV (RNP) AR instrument approach procedures. Operators are responsible to determine equipment needed and submit these requirements along with other data to their applicable regulators in order to get approval for RNAV (RNP) AR operations.

Operators who have been approved to conduct these operations and have airplanes certified for these operations are encouraged to create a customized RNAV (RNP) AR Approach Review Card to provide information to their flight crews.

Note: More detailed information concerning AR operational and training requirements can be found in FAA advisory circulars or similar documents.

Alternate Go-Around and Missed Approach Procedure

Training Information

With operational approval, operators may use the "Alternate Go-Around and Missed Approach Procedure" in the Supplementary Procedures section of the FCOM. This option allows operators to use a flaps 30 landing with a flaps 5 go-around for return-to-land performance considerations.

The FAA Aircraft Evaluation Group (AEG) has reviewed the flaps 30 landing/flaps 5 go-around procedure and determined the minimum training required for flight crews of U.S. operators. See the FAA 737 Flight Standardization Board (FSB) report for ground and simulator training requirements for the Alternate Go-Around and Missed Approach procedure..

Flare and Touchdown

Hard Landing

[FCTM 6.119](#)

Boeing considers pilot reporting as the sole determination of a hard landing. Landing acceleration data from the airplane Digital Flight Data Recorder (DFDR) can be used to determine the level of inspections required after a pilot report of a hard landing, but not to determine if a hard landing was made.

Landing Roll

Factors Affecting Landing Distance

Slippery Runway Landing Performance

FCTM 6.36

Slippery/contaminated runway advisory information is based on an assumption of uniform conditions over the entire runway. This means a uniform depth for slush/standing water for a contaminated runway or a fixed braking coefficient for a slippery runway. The data cannot cover all possible slippery/contaminated runway combinations and does not consider factors such as rubber deposits or heavily painted surfaces near the end of most runways. With these caveats in mind, it is up to the operator to determine operating policies based on the training and operating experience of their flight crews.

Crosswind Landings

Landing Crosswind Guidelines

FCTM 6.46

Crosswind guidelines are not considered limitations. Crosswind guidelines are provided to assist operators in establishing their own crosswind policies. These guidelines are based upon steady wind (no gust) conditions. Operators need to address the increased workload associated with gusts when developing their own crosswind policies. If an operator is unable to establish crosswind policies, with gusts, the recommended crosswind guidelines provided should be used.

Rapid Descent

FCTM 7.5

Some routes over mountainous terrain require careful operator planning to include carrying additional oxygen, special procedures, higher initial level off altitudes, and emergency routes in the event a depressurization is experienced. These requirements are normally addressed in an approved company route manual or other document that addresses route specific depressurization procedures.

Terrain Avoidance

Terrain Avoidance - RNAV (RNP) AR Operations

FCTM 7.19

Terrain warning-level alerts always require immediate action. The most appropriate crew actions regarding airplane bank angle and track during a terrain avoidance maneuver depend on where the maneuver is initiated. Operators should determine the most appropriate course of action for each leg of the procedure, if necessary, so crews are prepared to react correctly at all times.

Operators are encouraged to report nuisance ground proximity alerts to airport authorities, Boeing, and to the appropriate avionics suppliers to enable appropriate corrective action.

Non-Normal Situation Guidelines

Landing at the Nearest Suitable Airport

FCTM 8.12

A suitable airport is defined by the operating authority for the operator based on guidance material, but in general must have adequate facilities and meet certain minimum weather and field conditions.

Engines, APU

Recommended Technique for an In-Flight Engine Shutdown

FCTM 8.18

Operators may develop their own crew coordination techniques for an in-flight engine shutdown. This technique should ensure that the objectives stated in the body of this manual are met. The section titled Recommended Technique for an In-Flight Engine Shutdown contains an example that could be used.



A

Acceleration to and Deceleration from VMO 7.1

Adverse Runway Conditions - Takeoff 3.21

Adverse Runway Conditions - Takeoff A.2.6

AFDS Autoland Capabilities 5.20

AFDS Faults 5.24

AFDS Guidelines 1.40

Airframe Vibration 8.18

Airspeed Unreliable 8.29

Alert Height - AH 5.14

Alternate Go-Around and Missed Approach Procedure A.2.10

Altitude Unreliable 8.33

Antiskid Inoperative - Landing 6.40

Antiskid Inoperative - Taxi 2.7

Approach Briefing 5.2

Approach Category 5.3

Approach Category A.2.8

Approach Clearance 5.4

Approach to Stall Recovery 7.13

Automatic Flight - AFDS 1.42

Automation Use Guidelines A.2.3

Autopilot Engagement - After Takeoff 3.32

Autothrottle Use 1.41

B

Balked Landing 6.30

Bird Strikes 8.19

Bounced Landing Recovery 6.29

Bug Setting with FMC Inoperative 1.17

C

Cabin Altitude Warning 8.13

Callouts 1.19

Cargo Fire 8.48



737 NG Flight Crew Training Manual

CAT II Operations	5.23
CAT III Operations	5.23
Category II Operations	5.23
Category III Operations	5.23
Center-Of-Gravity Effects on Takeoff	3.13
Circling Approach - One Engine Inoperative	5.72
Circling Approach	5.68
Climb Constraints	4.1
Climb Performance Takeoff (Improved)	3.20
Cold Temperature Altitude Corrections	1.28
Cold Temperature Altitude Corrections	A.2.2
Command Speed - Non-Normal Conditions	1.15
Command Speed	1.14
Control Wheel Steering	1.43
Crew Resource Management	1.5
Crosswind Guidelines - Takeoff	3.14
Crosswind Landings	6.46
Crosswind Landings	A.2.11
Crosswind Takeoff	3.14
Crosswind Takeoff	A.2.5
Cruise Performance Economy	4.9
D	
Damage Assessment and Airplane Handling Evaluation	8.53
Decision Altitude or Height - DA(H)	5.14
Decision Altitude or Height - DA(H)	5.19
Derated Takeoff Thrust (Fixed Derate)	3.18
Descent Constraints	4.17
Descent Path	4.17
Descent Planning	4.18
Descent Rates	4.18
Descent Speed Determination	4.17
Display Panel Management	1.6
Ditching	8.14
E	

737 NG Flight Crew Training Manual

Economy Climb Schedule - FMC Data Unavailable	4.4
Economy Climb	4.4
Electronic Flight Bag	1.24
Engine Failure During a Combined ATM and Fixed Derate Takeoff	A.2.6
Engine Failure During a Combined ATM and Fixed Derate	3.42
Engine Failure During a Derated Takeoff Thrust (Fixed Derate)	3.41
Engine Failure During a Reduced Thrust (ATM) Takeoff	3.41
Engine Failure Recognition - Takeoff	3.35
Engine Failure versus Engine Fire After Takeoff	8.15
Engine Icing During Climb	4.3
Engine Icing During Descent	4.21
Engine Inoperative Climb	4.4
Engine Inoperative Cruise/Driftdown	4.11
Engine Inoperative, Rudder Trim - All Instrument Approaches	5.30
Engine Oil System Indications	8.15
Engine Out Familiarization	7.2
Engine Out Taxi	2.17
Engine Tailpipe Fire	8.15
Erroneous Angle of Attack (AOA) Indications	8.34
ETOPS	4.13
ETOPS	A.2.7
Evacuation	8.20
F	
Fire	8.47
Flap Configurations for Approach and Landing	5.7
Flap Extension Schedule	5.8
Flap Extension using the Alternate System	8.23
Flap Maneuver Speeds	1.6
Flap Retraction - One Engine Inoperative	3.40
Flap Retraction Schedule	3.32
Flaps and Landing Gear	4.20
Flaps Up Landing	8.21
Flare and Touchdown	6.7
Flare and Touchdown	A.2.10

Flight Deck Philosophy	1.1
Flight Management Computer(s)/CDUs	1.32
Flight Path Vector	1.26
FMC Route Verification Techniques	1.32
Fuel Balance	8.34
Fuel for Enroute Climb	4.8
Fuel Leak	8.35
Fuel Temperature	4.8
G	
Go-Around after Touchdown	5.84
Go-Around and Missed Approach - All Approaches (FMC U10.6 and earlier)	5.80
Go-Around and Missed Approach - All Approaches (FMC U10.7 and later)	5.81
Go-Around and Missed Approach - All Engines Operating	5.82
Go-Around and Missed Approach - Engine Failure During	5.85
Go-Around and Missed Approach - One Engine Inoperative	5.85
Go/Stop Decision Near V1	3.26
GPS Use in Non-WGS-84 Reference Datum Airspace	1.40
GPS Use in Non-WGS-84 Reference Datum Airspace	A.2.3
H	
Hard Landing	6.32
Head Up Display (HUD)	1.46
Headphone and Flight Deck Speaker Use	1.6
High Altitude High Speed Flight	4.13
High Altitude Maneuvering, "G" Buffet	7.4
Holding Airspeeds (FAA)	4.22
Holding Airspeeds (ICAO)	4.22
Holding	4.21
HUDS - Descent Preparation	4.18
HUDS - Flare and Touchdown	6.9
HUDS - Low Visibility Takeoff	3.21
Hydraulic System(s) Inoperative - Landing	8.37

I

737 NG Flight Crew Training Manual

Ice Crystal Icing	1.29
Icing - Operation in Icing Conditions	1.28
Icing - Training Flights in Icing Conditions.	1.30
ILS - One Engine Inoperative	5.29
ILS - One Engine Inoperative	5.30
ILS Approach - Landing Geometry	5.28
ILS Approach.	5.12
ILS or GLS Approach	5.10
ILS or GLS Approach	A.2.8
ILS Performance	5.20
Immediate Turn after Takeoff - All Engines.	3.30
Immediate Turn after Takeoff - One Engine Inoperative.	3.39
Initial Climb - All Engines.	3.30
Initial Climb - One Engine Inoperative.	3.39
Instrument Approach - RNAV (RNP) AR.	5.62
Instrument Approach Using VNAV	5.46
Instrument Approach Using V/S	5.58
Instrument Approaches	5.1
Integrated Approach Navigation (IAN)	5.52
J	
Jammed or Restricted Flight Controls.	8.24
L	
Landing at the Nearest Suitable Airport	8.12
Landing at the Nearest Suitable Airport	A.2.12
Landing Distance (Factors Affecting)	6.33
Landing Distance (Non-Normal)	6.36
Landing Flare Profile	6.8
Landing Gear Lever Locked Up	8.38
Landing Minima.	5.7
Landing on a Flat Tire	8.40
Landing Roll	6.32
Landing Roll	A.2.11
Leading Edge Flaps Transit - Landing	8.23
Liftoff - Effect of Rotation Speed and Pitch Rate.	3.12

LNAV - Non-ILS Approach	5.39
Loss of Engine Thrust Control	8.16
Loss of Thrust on Both Engines	8.17
Low Altitude Level Off - During Climb	4.2
Low Fuel Operations In-flight	8.36
Low Visibility Approaches	5.22
Low Visibility Takeoff	3.20
Low Visibility Takeoff	A.2.5
M	
Maintenance Inspection (Events Requiring)	1.4
Maintenance Inspection (Events Requiring)	A.2.1
Maneuver Margin - Landing and Go-Around	5.8
Maneuver Margins to Stick Shaker	1.10
Maneuver Speeds and Margins	1.6
Manual Flight	1.41
Manual Stabilizer Trim	8.27
Maximum Altitude - Cruise	4.5
Maximum Altitude - Cruise	A.2.6
Maximum Angle Climb	4.4
Maximum Rate Climb	4.4
Minimum Fuel Operation - Takeoff	3.30
Minimum Maneuver Speed	1.7
Missed Approach - Non-ILS	5.67
Missed Approach Point	5.9
Missed Approach (Mandatory Conditions)	5.6
Moderate to Heavy Rain, Hail, or Sleet - Flight in	1.48
N	
Noise Abatement - One Engine Inoperative	3.41
Noise Abatement Takeoff	3.34
Non - ILS Instrument Approach - Vertical Path Construction	5.43
Non - ILS Instrument Approaches	5.34
Non-Normal Operations	5.29
Non-Normal Situation Guidelines	8.2
Non-Normal Situation Guidelines	A.2.12

737 NG Flight Crew Training Manual

Nose Wheel/Rudder Pedal Steering	2.7
O	
Operational Philosophy	1.4
Operational Philosophy	A.2.1
Optimum Altitude - Cruise	4.6
Optimum Altitude - Cruise	A.2.7
Overspeed	8.43
Overweight Landing	6.50
P	
Partial or Gear Up Landing	8.40
Pilot Incapacitation	1.47
Pitch and Roll Limit Conditions	6.25
Pitch Modes - Takeoff	3.31
Polar Operations	4.15
Polar Operations	A.2.8
Precision Approach Path Indicator (PAPI)	6.5
Procedure Holding	4.22
Procedure Turn and Initial Approach - ILS	5.14
Procedure Turn and Initial Approach - Non-ILS Approaches	5.43
Procedure Turn	5.4
Push Back or Towing	2.2
Push Back or Towing	A.2.4
Push Back or Towing	A.2.4
Q	
Qualification Requirements (Checkride)	1.5
R	
Radio Altimeter	5.7
Rapid Descent	7.5
Rapid Descent	A.2.11
Raw Data - (No Flight Director) - ILS	5.19
Raw Data Monitoring Requirements - Non-ILS	5.36
Raw Data Monitoring Requirements - Non-ILS	5.38
Recommended Technique for an In-Flight Engine Shutdown	8.18
Reduced and Derated Takeoff Thrust	3.17



737 NG Flight Crew Training Manual

Reduced Takeoff Thrust (ATM)	3.18
Reduced Thrust Climb	4.1
Reference Bugs	1.16
Rejected Landing	6.30
Rejected Takeoff Decision	3.24
Rejected Takeoff Maneuver	3.24
Resolution Advisory	7.20
Reverse Thrust Operation - Landing Roll	6.42
Reverse Thrust (Ground)	2.5
RNAV Operations	1.33
RNAV Operations	A.2.2
RNP APCH	A.2
Roll Modes - Takeoff	3.31
Rotation and Liftoff - All Engines	3.8
Rotation and Liftoff - One Engine Inoperative	3.35
RTO Execution Operational Margins	3.27
Rudder Trim Technique - Recommended	1.30
Runaway Stabilizer	8.27
Runway Markings (Typical)	6.6
S	
Situations Beyond the Scope of Non-Normal Checklists	8.50
Speed Intervention	4.18
Speed Restrictions	4.21
Speedbrakes	4.19
Stabilized Approach Recommendations	5.4
Stabilizer Trim Inoperative	8.26
Stall Recovery	7.11
Standby Rudder On	8.28
Steep Turns	7.17
Stop and Go Landings	5.78
T	
Tail Strike	8.44
Takeoff - Adverse Runway Conditions	3.21
Takeoff - Combination ATM and Fixed Derate	3.19

737 NG Flight Crew Training Manual

Takeoff - Crosswind	3.14
Takeoff - Engine Failure	3.35
Takeoff - Reduced and Derated Takeoff Thrust	3.17
Takeoff - Tail Clearance	3.10
Takeoff - Tail Clearance	3.37
Takeoff Briefing	2.2
Takeoff Crosswind Guidelines	3.14
Takeoff Crosswind Guidelines	A.2.5
Takeoff Engine Failure	A.2.6
Takeoff Field Length	3.22
Takeoff Flap Setting	3.4
Takeoff Profile	3.2
Takeoff Profile	3.3
Takeoff	3.1
Taxi - Adverse Weather	2.16
Taxi - Engine Out	2.17
Taxi - Minimum Radius	2.11
Taxi Speed and Braking	2.5
Terrain Avoidance	7.18
Terrain Avoidance	A.2.12
Threshold Height	6.7
Thrust Management - Takeoff	3.5
Thrust Use - Taxi	2.5
Tire Failure during or after Takeoff	8.39
Touch and Go Landings	5.77
Touchdown Body Attitudes	6.10
Traffic Advisory	7.19
Traffic Alert and Collision Avoidance System	7.19
Trailing Edge Flap Asymmetry - Landing	8.23
Training Objectives	1.5
Transition to Climb	4.3
Troubleshooting	8.11
Turbulent Air Penetration	1.49

U



Upset Recovery	7.21
--------------------------	------

V

Vertical Situation Display (VSD)	1.27
Visual Aim Point.	6.5
Visual Approach Slope Indicator (VASI/T - VASI)	6.1
Visual Descent Point	5.66
Visual Traffic Pattern	5.74
VNAV - Non-ILS Approaches	5.40

W

Weather Radar and Terrain Display Policy	1.40
Wheel Well Fire	8.48
Window Damage	8.49
Window(s) Open	8.49
Windshear	7.26

UNCONTROLLED
IF PRINTED