

Name: _____

Date: _____

Tracing Pictures

Trace the lines to complete the picture.

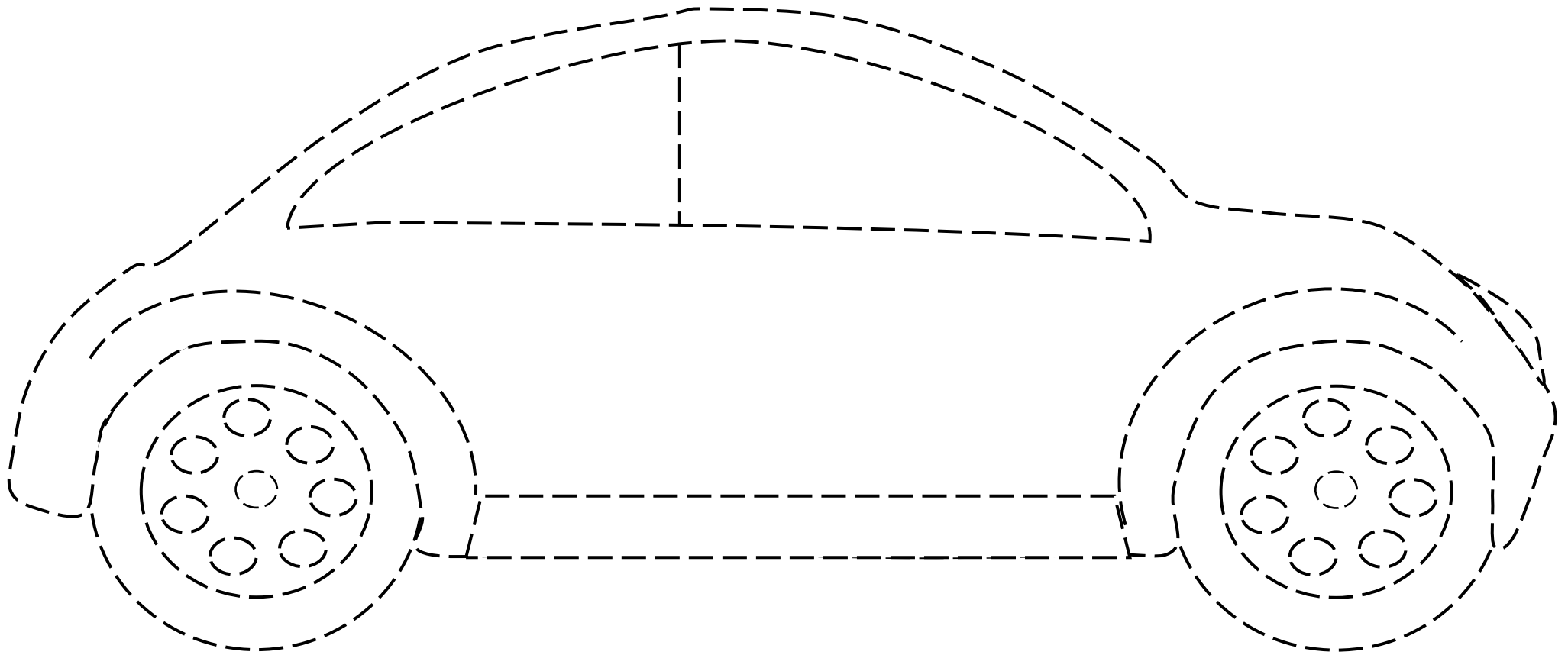

Name: _____

Date: _____

Tracing Pictures

Trace the lines to complete the picture.

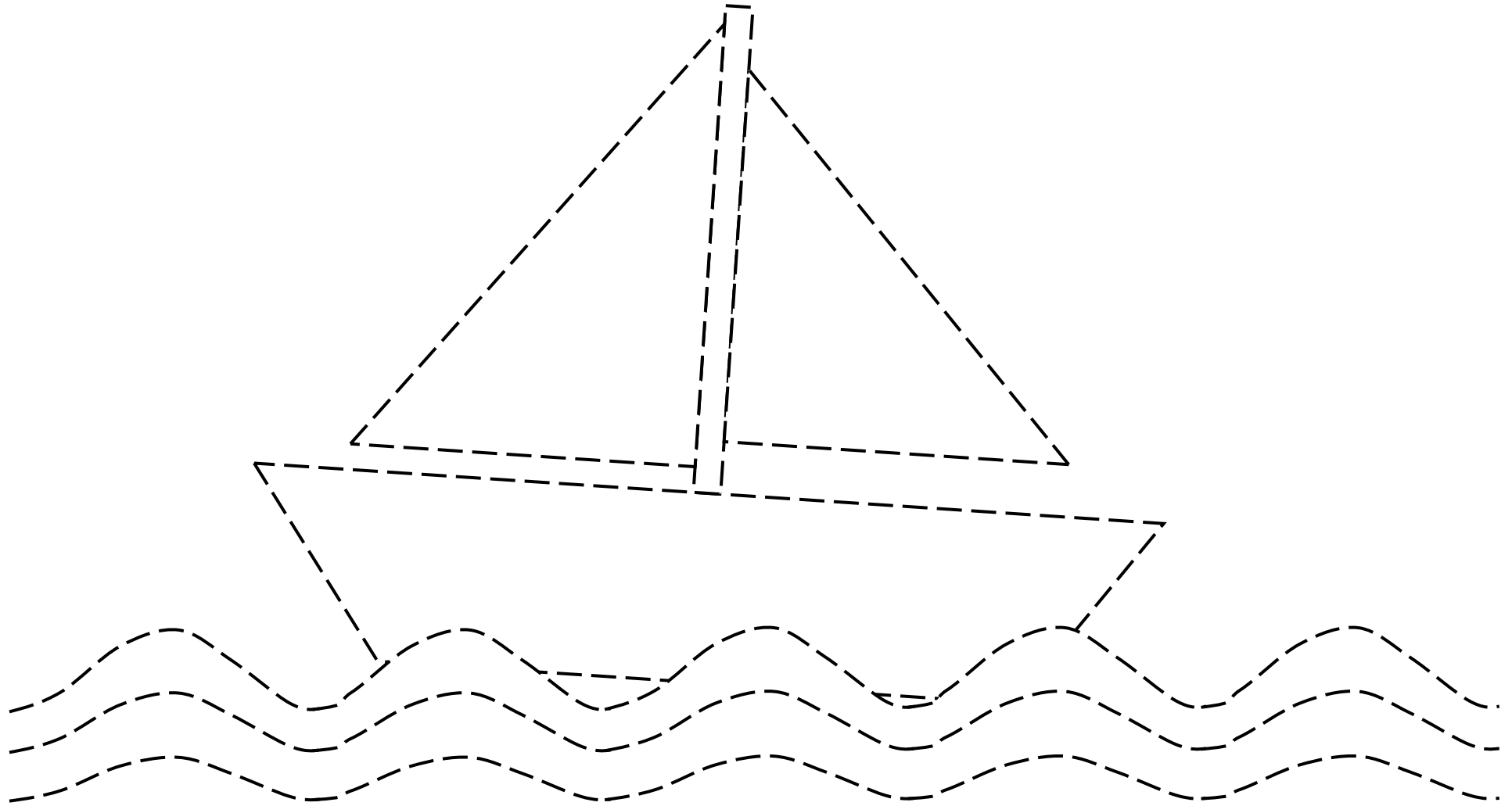

Name: _____

Date: _____

Tracing Pictures

Trace the lines to complete the picture.

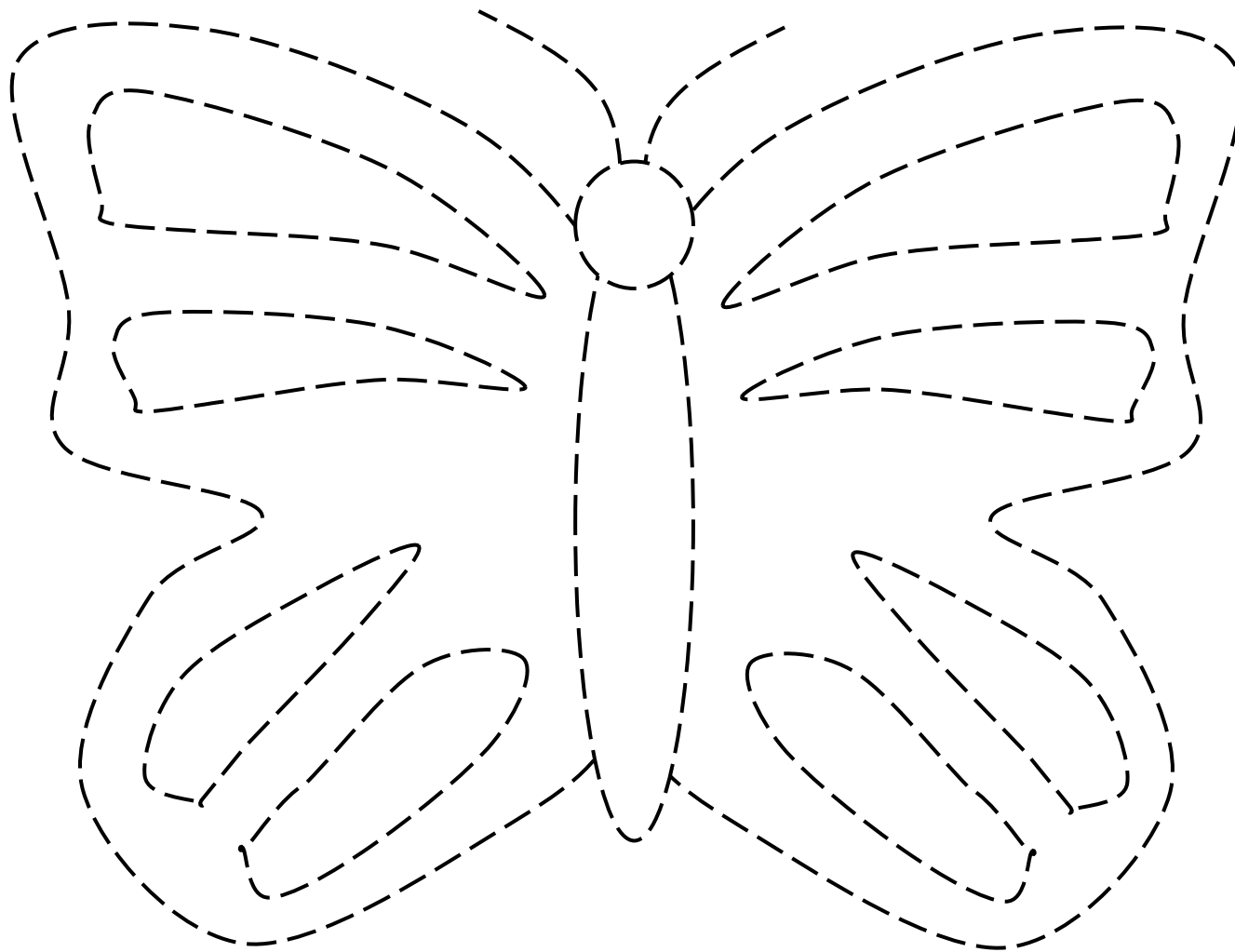

Name: _____

Date: _____

Tracing Pictures

Trace the lines to complete the picture.

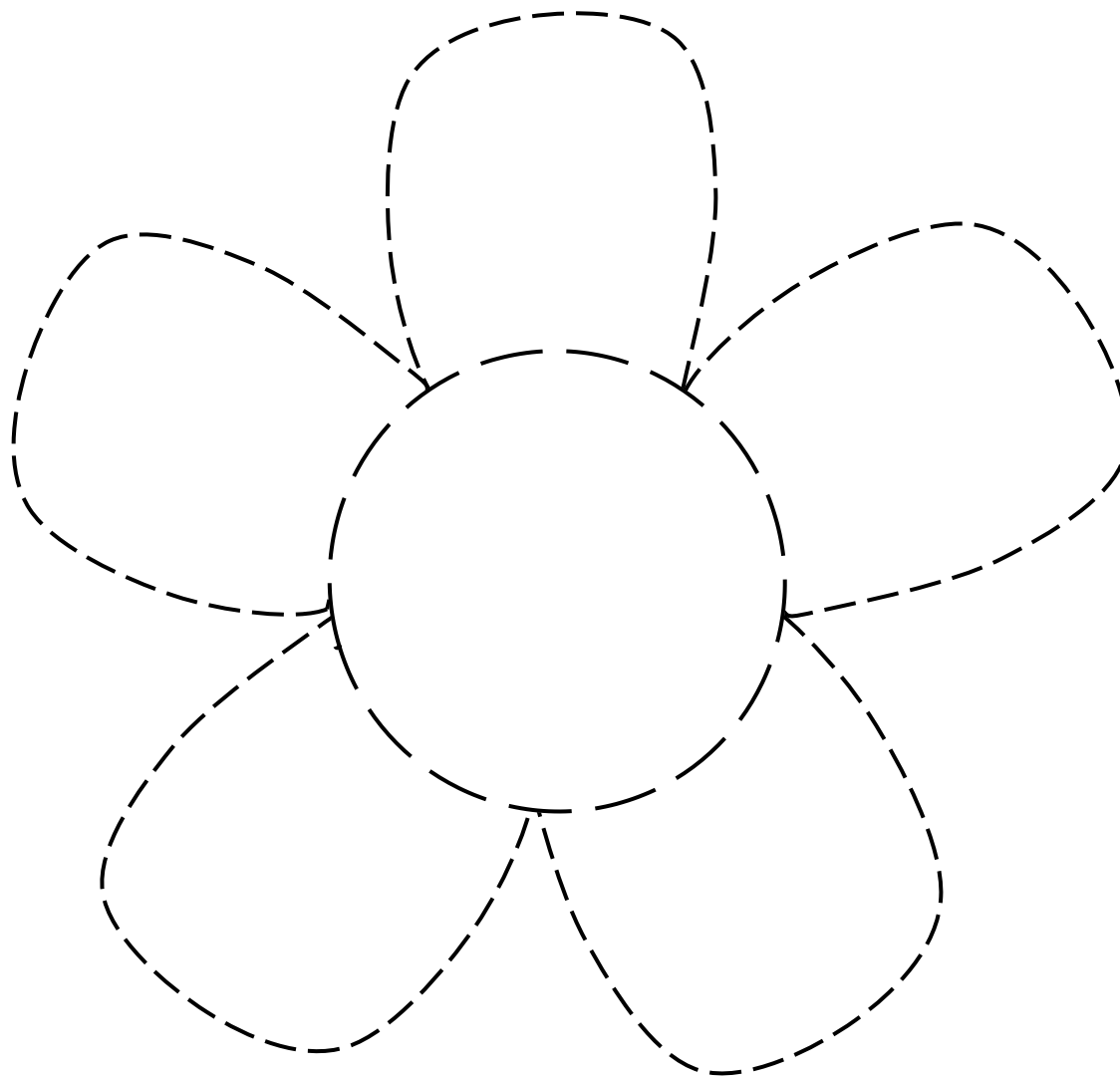

Name: _____

Date: _____

Tracing Pictures

Trace the lines to complete the picture.

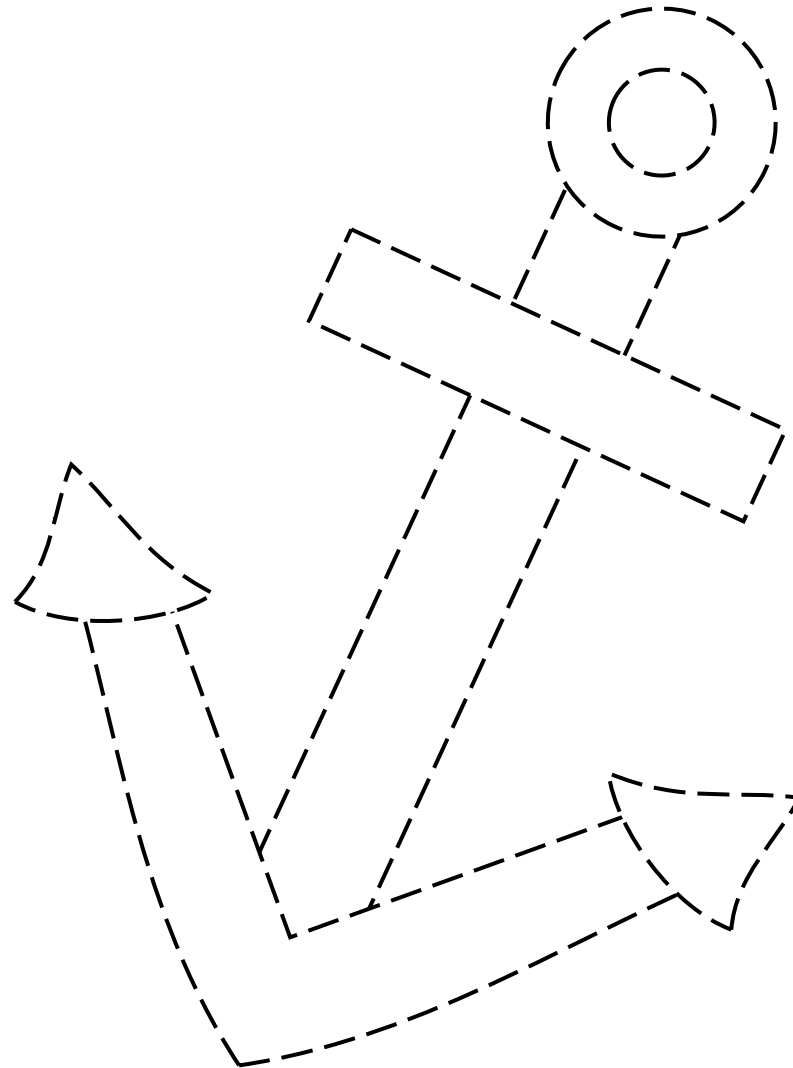

Name: _____

Date: _____

Tracing Pictures

Trace the lines to complete the picture.

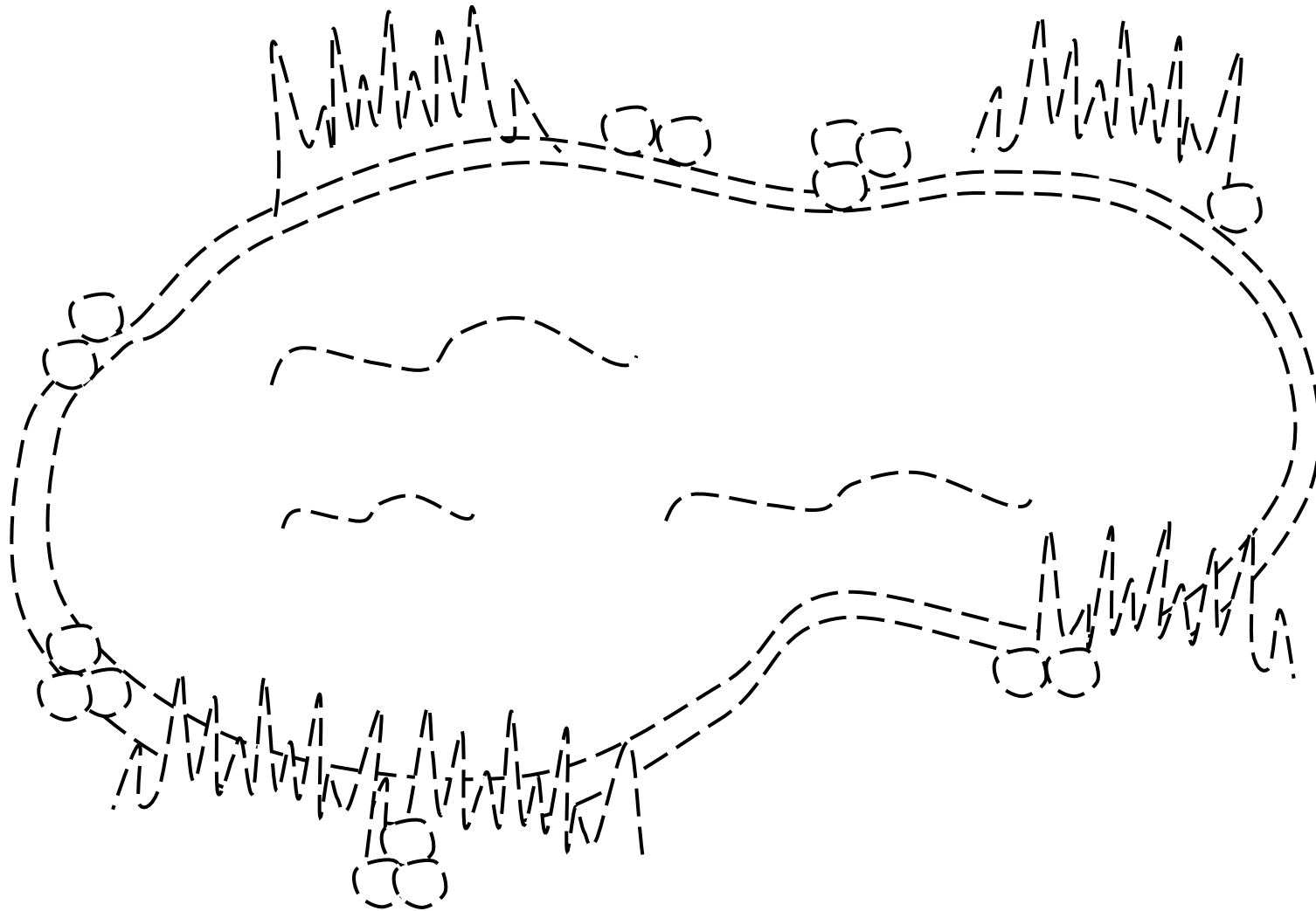

Name: _____

Date: _____

Tracing Pictures

Trace the lines to complete the picture.

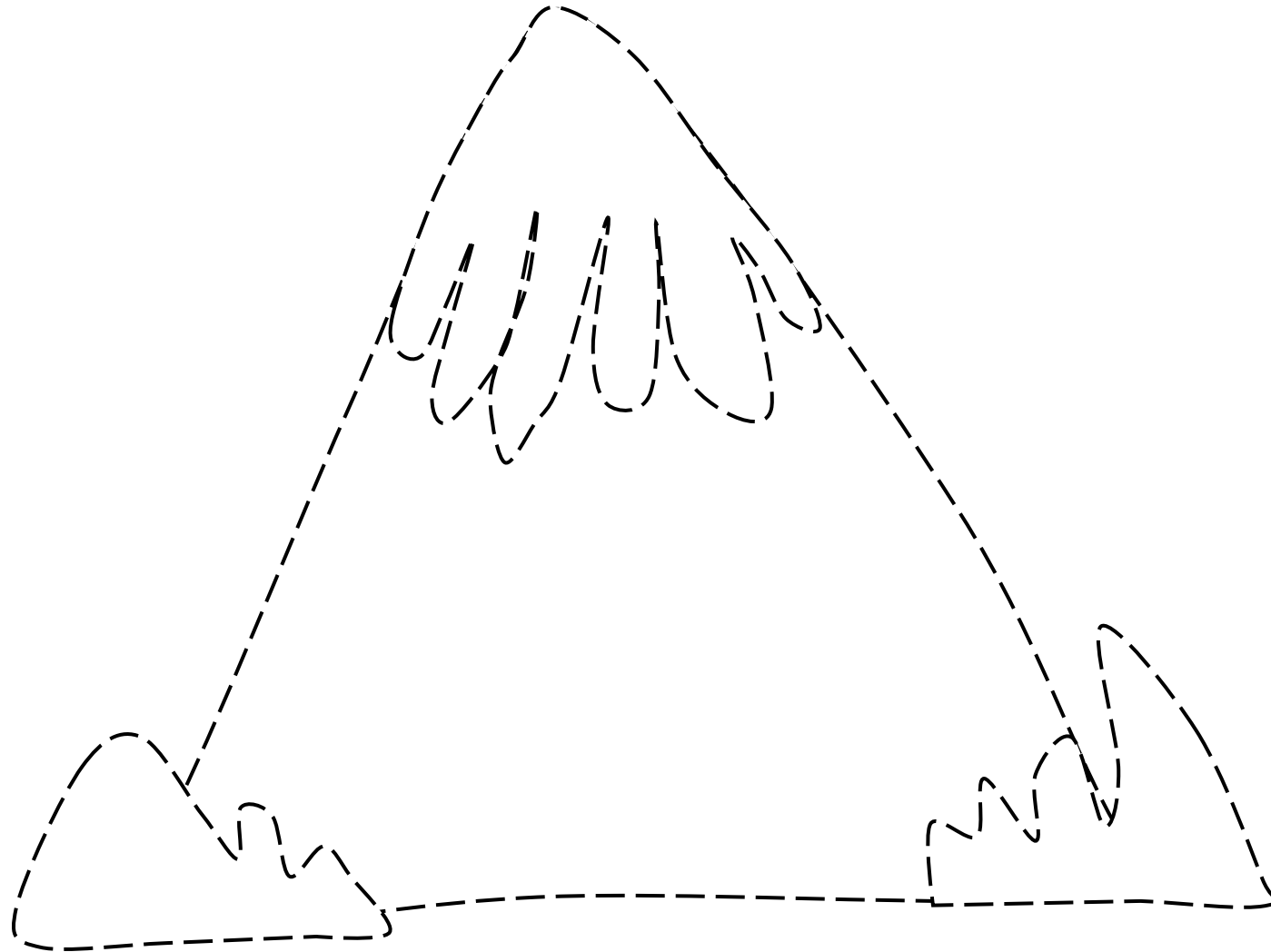

Name: _____

Date: _____

Tracing Pictures

Trace the lines to complete the picture.

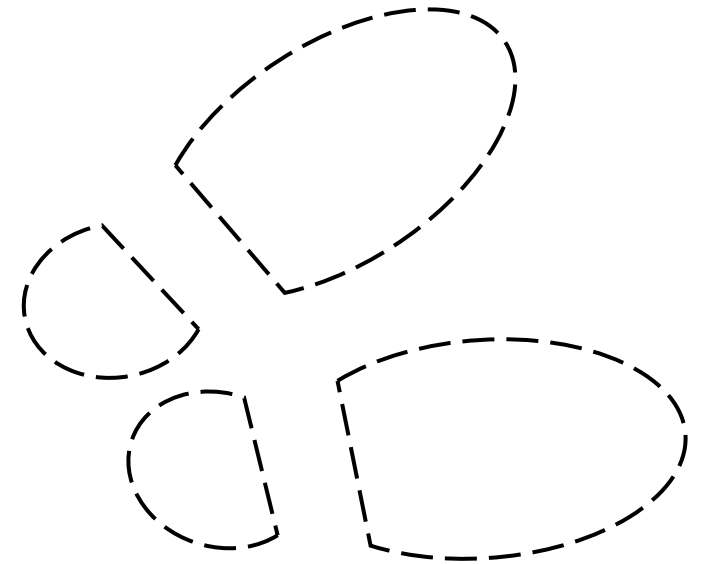
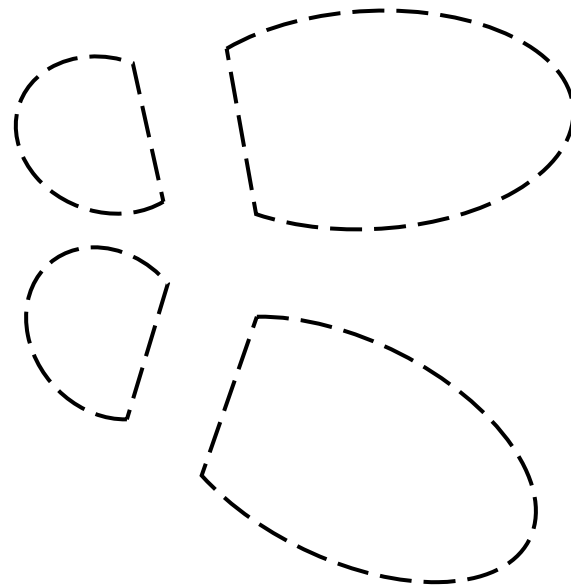
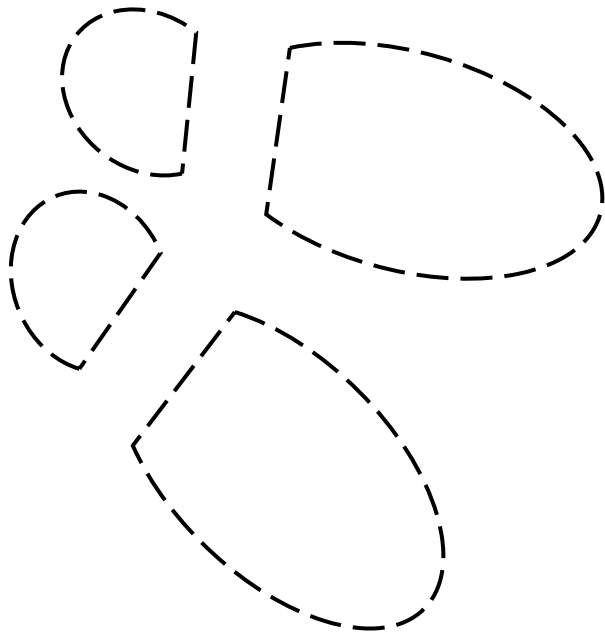

Name: _____

Date: _____

Tracing Pictures

Trace the lines to complete the picture.

