

## Lista de Recambios / Spare part list

Nº Ident / Ident-no 008600100  
Nombre / term FA 416 E2/E3



Cliente / customer

Proyecto / project

Fecha / stand Febrero 2015



# Lista de Recambios / Spare part list

Nº Ident / Ident-no      008600100  
Nombre / term            FA 416 E2/E3









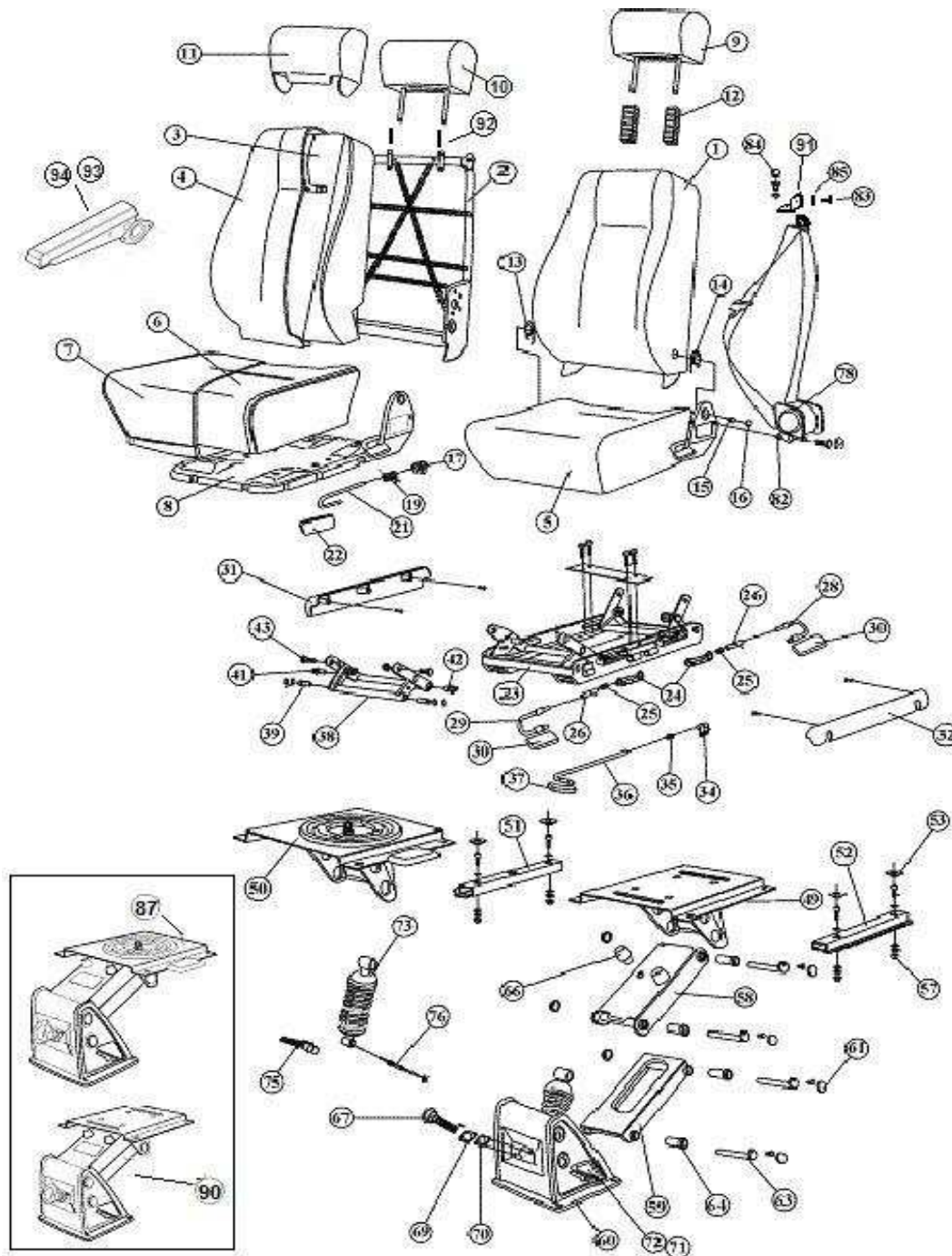



Cliente / customer













Proyecto / project

Fecha / stand            Febrero 2015



Nº	Referencia	Foto/Photo	Denominación	Description	Comentarios/Remarks
Nr	Part no.				
1	0086043XX		Respaldo tapizado	Trimmed backrest	Facilitar nº obra y posicion / Body number and position is required
2.1	008601311-PNT		Armadura respaldo E2	Backrest E2 frame	
2.2	008601310-PNT		Armadura respaldo E3	Backrest E3 frame	
3	008610302		Espuma de respaldo	Backrest foam	
4	008603300-CFG		Funda de respaldo	Backrest cover	Facilitar nº obra y posicion / Body number and position is required
5	0086044XX		Cojin tapizado	Trimmed cushion	Facilitar nº obra y posicion / Body number and position is required
6	008610404		Espuma de cojin	Cushion foam	
7	Configurable		Funda de cojin	Cushion cover	Facilitar nº obra y posicion / Body number and position is required
8	008601405-PNT		Armadura de cojin	Cushion frame	
9	0086045XX		Cabezal tapizado	Trimmed headrest	Facilitar nº obra y posicion / Body number and position is required
10	002710501		Espuma de cabezal	Headrest foam	
11	Configurable		Funda de cabezal	Headrest cover	Facilitar nº obra y posicion / Body number and position is required

Nº	Referencia	Foto/Photo	Denominación	Description	Comentarios/Remarks
Nr	Part no.				
12	4-7451		Fuelle de cabezal	Headrest gusset	
13	008609304		Muelle espiral derecho	Right spiral spring	
14	008609303		Muelle espiral izquierdo	Left spiral spring	
15	008608202		Tornillo giro respaldo	Backrest swivel bolt	
16	009940901		Caperuza tornillo giro respaldo	Backrest swivel bolt cap	
17	008665401		Sector de bloqueo	Blocking sector	
19	008609302		Muelle de torsion	Torsion spring	
21	009965207		Palanca reclinacion izquierda	Left reclining lever	
22	009940016		Asidero palanca amarillo	Yellow lever grip	
23	008601103-PNT		Bastidor plataforma standard	Standard platform frame	
24	009965108		Chapa dentada de bloqueo	Serrated blocking plate	
25	009909301		Muelle palanca elevacion	Raising lever spring	

	Referencia	Foto/Photo	Denominación	Description	Comentarios/Remarks
	Part no.				
26	009950102		Tubo separador	Separating tube	
28	009965202		Palanca elevacion derecha	Right raising lever	
29	009965201		Palanca elevacion izquierda	Left raising lever	
30	009940016		Asidero palanca amarillo	Yellow lever grip	
31	009940010		Embellecedor derecho	Right trimming	
32	009940009		Embellecedor izquierdo	Left trimming	
34	009965209		Palanca bloqueo	Blocking lever	
35	009909302		Muelle palanca accionamiento	Operating lever spring	
36	008665204		Palanca accionamiento	Operating lever	
37	009940017		Asidero palanca accionamiento	Operating lever grip	
38	008602002-PNT		Conjunto articulacion	Articulation group	
39	008608303		Bulon soporte acanalado	Fluted support rivet	

	Referencia	Foto/Photo	Denominación	Description	Comentarios/Remarks
	Part no.				
41	008608403		Eje deslizante	Slinding axis	
42	008608402		Eje cremallera	Rack axis	
43	008608203		Tornillo de vastago	Rod bolt	
49	008601723-PNT		Soporte asiento	Seat support	
50	008604702		Mecanismo giratorio	Swivelling mechanism	
51	008665103		Guia tope recorrido	Stop guide	
52	008665102		Guia anclaje	Anchoring guide	
53	008640602		Disco deslizamiento	Sliding disk	
57	008640401		Protector tuerca	Nut protector	
58	008605005-PNT		Brazo soporte	Arm support	
59	008605004-PNT		Palanca oscilante	Oscilationg lever	
60	008601724-PNT		Pie asiento	Seat foot	

	Referencia	Foto/Photo	Denominación	Description	Comentarios/Remarks
	Part no.				
61	008640901		Caperuza arandela fijacion	Fastening washer cap	
63	008665402		Conjunto eje cincado	Zinc axis group	
64	008640103		Casquillo cojinete	Bearing fitting	
66	005740701		Tope amortiguador	Shock absorber stop	
67	008640302		Pomo estrella amarillo	Yellow star knob	
69	008665104		Sujecion disco freno	Brake disk fastening	
70	008640001		Disco freno	Brake disk	
71	008669105		Etiqueta indicador peso izquierda	Weight Indicator label left	
72	008669106		Etiqueta indicador peso derecha	Weight Indicator label right	
73	008607101		Amortiguador	Shock absorber	
75	008665105		Husillo desplazable	Sliding screw	
76	008605002		Bulon señalizador amarillo	Yellow signalling button	
78.1	000699827		Carrete 2 puntos	Belt 2 point	

	Referencia	Foto/Photo	Denominación	Description	Comentarios/Remarks
	Part no.				
78.2	000699804		Carrete 3 puntos	Belt 3 point	
79.1	000699907		Hebilla 2 puntos	Buckle 2 point	
79.2	000699922		Hebilla 3 puntos	Buckle 3 point	
82	448608101		Casquillo fijacion cinturón	Belt fastening fitting	
83	001208204		Tornillo fijacion cinturón	Belt fastening bolt	
84	000699528		Caperuza tornillo cinturon	Belt bolt cap	
85	004608108		Casquillo giro reenvio	Resending twisting cap	
87	008604714		Conjunto pie FA-416 giratorio	Driver foot - twist	
90	008604712		Conjunto pie FA-416 standard	Driver foot - standard	
91	008620402		Escuadra sujecion cinturon	Belt fastening angle bracket	
92	006440101-N50		Casquillo cabezal	Headrest cap	
93	10168-00		Apoyabrazos derecho	Right armrest	
94	10167-00		Apoyabrazos izquierdo	Left armrest	