

Introduction

Vinbelltech's ACM90S miniature, open-loop current sensors incorporate our AH69X Series miniature ratiometric linear Hall-effect sensor. The sensing element is encapsulated in a printed circuit board-mountable plastic package. The combination of sensor, flux collector and housing comprises the current sensor assembly. These sensors are ratiometric output.

Features

- Open-loop, through-hole design
- Output voltage isolation from input
- ac or dc current sensing
- Linear ratiometric output
- Current sinking or sourcing output for interfacing flexibility
- Fast response time
- Compact size
- Accurate, low-cost sensing
- Minimum energy dissipation
- Maximum current limited only by conductor size
- Built-in temperature compensation promotes reliable operation
- Operating temperature range -40 °C to 125 °C
- RoHs compliant (lead-free)

Applications

- Motor control in appliances, HVAC and consumer tools
- Current monitoring of electronic circuits
- Overcurrent protection
- Ground fault detectors
- Robotics
- Industrial process control
- UPS and telecommunication power supplies
- Welding current monitoring
- Battery management systems in mobile equipment
- Watt meters
- Variable speed drives

Package

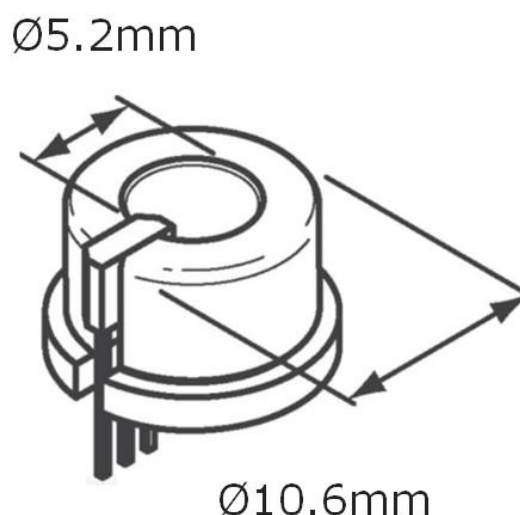

Product specification

Product type	Hall-effect linear open-loop current sensor
Package quantity	25 per box
Package style	PC board mount - radial lead IC
Supply voltage	4.5 Vdc to 10.5 Vdc
Output type	sink/source
Magnetic actuation type	analog ratiometric

Parameter	Symbol	Min.	Typ.	Max	Units	Condition
Current range	I_p		± 97		A	$< \pm 1.5\%$ error (-40°C to 125°C)
Supply voltage	V_s	4.5	5	10.5	V	
Vout @ 0 NI	V_o	2.43	2.5	2.57	V	
Supply current	I_s		4.8	7	mA	no load
Sensitivity	Sens	18.5	20.5	22.5	mV/A	-40 to 125°C
Hysteresis	Hys			0.5	%	$\pm 97\text{A}$
Temp error-null	TCnull	-0.054		0.054	$\%/^\circ\text{C}$	-40°C to 125°C
Temp error-gain	TCgain	-0.08		0.08	$\%/^\circ\text{C}$	-40°C to 125°C
Rise time	t_r		3		μs	

Block diagram

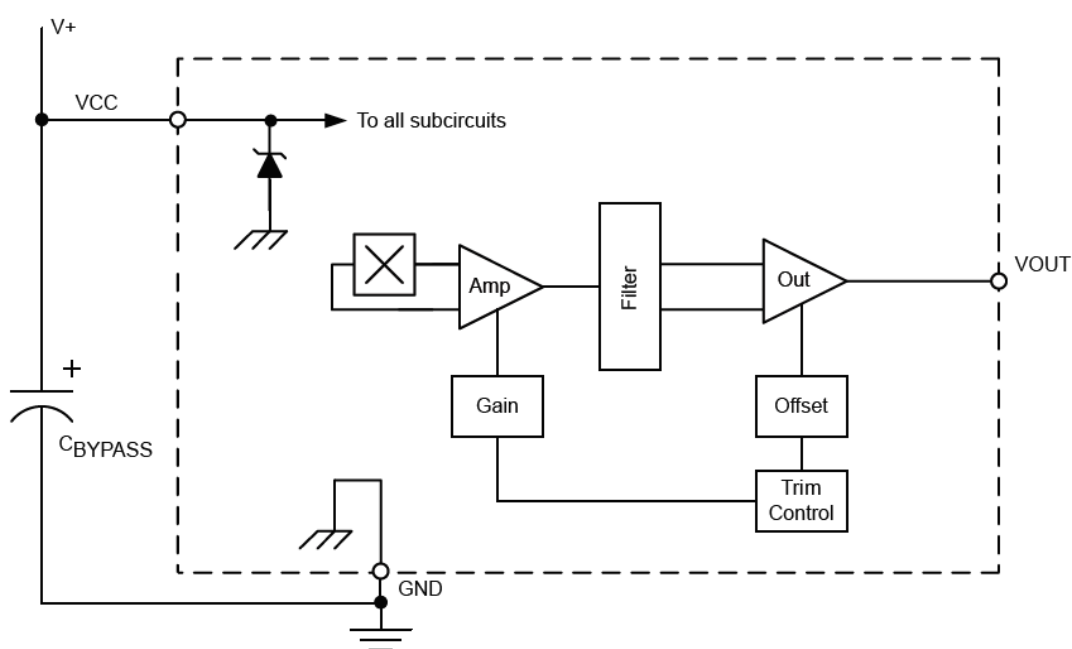

Typical transfer function (25 °C)

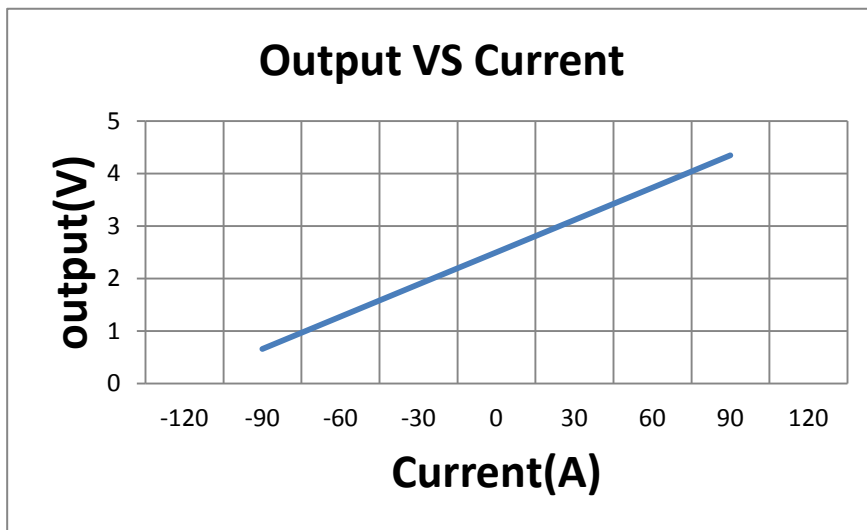

Dimensional drawing (mm)

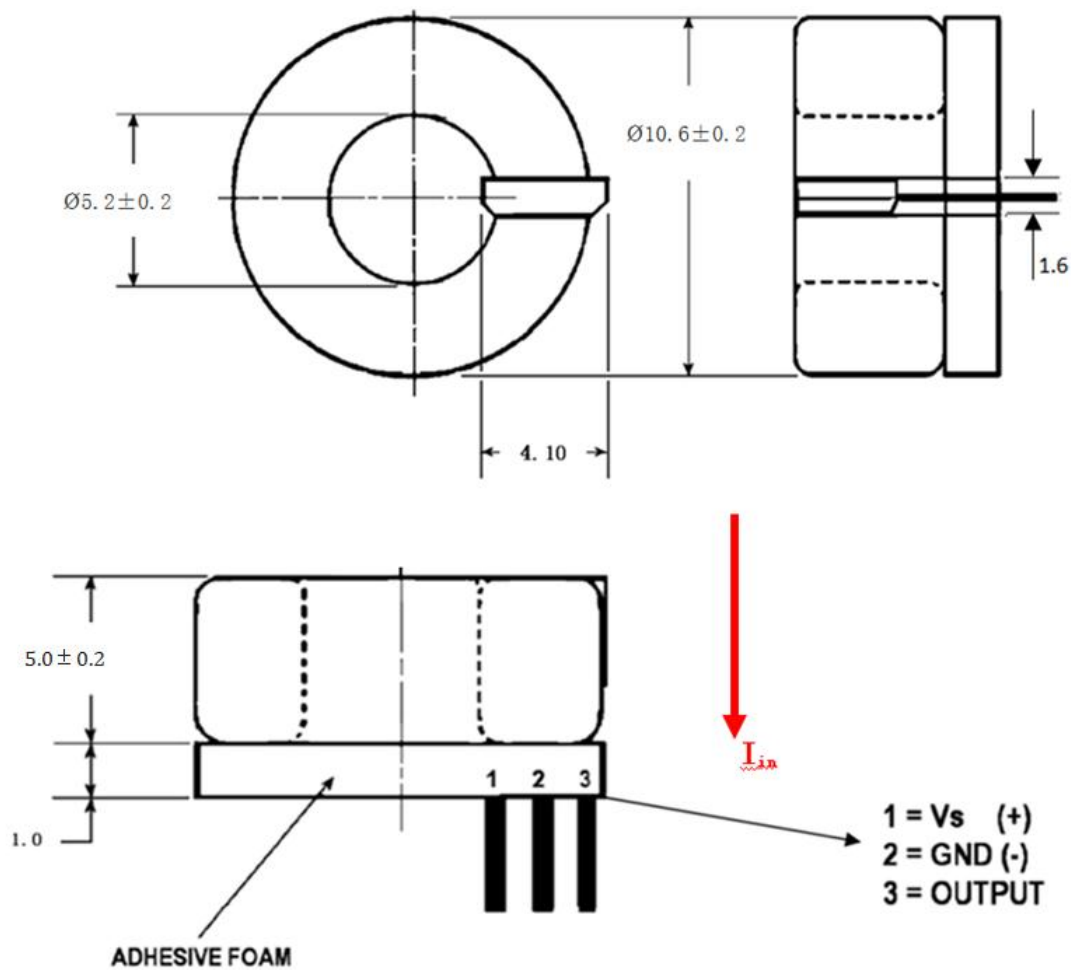

Copyright ©2019, Vinbelltech Co. Ltd

Vinbelltech Co. Ltd reserves the right to make, from time to time, such departures from the detail specifications as may be required to permit improvements in the performance, reliability, or manufacturability of its products. Before placing an order, the user is cautioned to verify that the information being relied upon is current.

Vinbelltech's products are not to be used in any devices or systems, including but not limited to life support devices or systems, in which a failure of Vinbelltech's product can reasonably be expected to cause bodily harm.

The information included herein is believed to be accurate and reliable. However, Vinbelltech Co. Ltd assumes no responsibility for its use; nor for any infringement of patents or other rights of third parties which may result from its use.